

INTERNATIONAL AEROBATIC CLUB SCORESHEET

A

Contest:

Date:

2022

Category:

Advanced

Programme:

Known

 pilot's
number

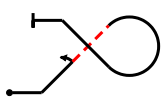
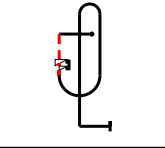
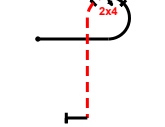
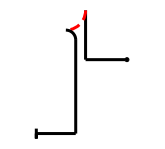
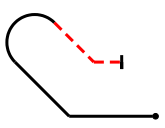
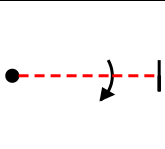
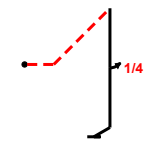
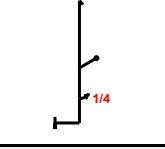
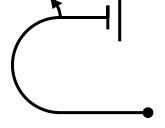
| No | Symbol | Cat. No. | K | Total K | Grade | Remarks | Item | K | Score | |
|----|---|---------------------|---------|---------|-------|---------|---|-----------------|-------|--|
| 1 |  | 1.1.1.1 9.1.3.4 | 2 12 | 14 | | | Presentation | 25 | | |
| 2 |  | 7.3.2.1 9.1.2.2 | 14 9 | 23 | | | FIGURE TOTAL K = | | 175 | |
| 3 |  | 8.8.8.3 9.11.1.6 | 19 7 | 26 | | | INC. PRESENTATION = | | 200 | |
| 4 |  | 8.6.22.1 9.4.3.2 | 13 8 | 21 | | | Aircraft type: | | | |
| 5 |  | 6.2.2.1 | 17 | 17 | | | FREE PROGRAM CHECKED BY: Signature: _____ Printed Name: _____ IAC No: _____ Date: _____ | | | |
| 6 |  | 8.4.13.1 | 11 | 11 | | | | Judge Name: | | |
| 7 |  | 1.1.1.2 9.1.3.4 | 3 12 | 15 | | | | IAC # | | |
| 8 |  | 1.2.2.2 9.1.5.1 | 13 3 | 16 | | | | Assistant Name: | | |
| 9 |  | 5.2.1.1 9.1.5.1 | 17 3 | 20 | | | | IAC # | | |
| 10 |  | 7.2.2.1 9.1.3.2 | 6 6 | 12 | | | | | | |



_____ Pilot
 _____ A/C



| | | |
|---|------------|--|
| B | Contest: | Category: |
| | Date: 2022 | Program: Known |
| | | Pilot's No. |

Pilot: _____

wind direction ←

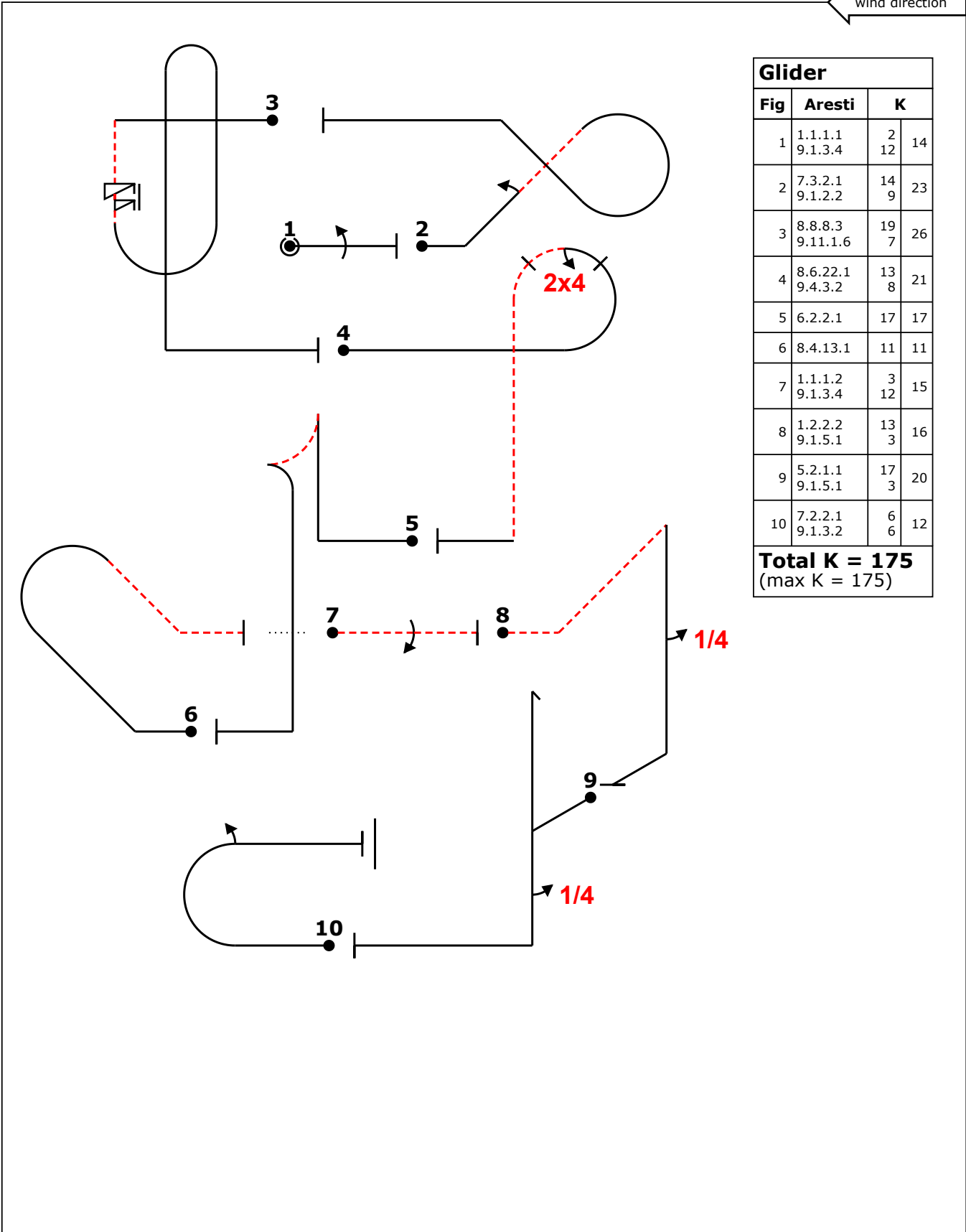

| Glider | | | |
|---------------------------------------|---------------------|---------|----|
| Fig | Aresti | K | |
| 1 | 1.1.1.1 9.1.3.4 | 2 12 | 14 |
| 2 | 7.3.2.1 9.1.2.2 | 14 9 | 23 |
| 3 | 8.8.8.3 9.11.1.6 | 19 7 | 26 |
| 4 | 8.6.22.1 9.4.3.2 | 13 8 | 21 |
| 5 | 6.2.2.1 | 17 | 17 |
| 6 | 8.4.13.1 | 11 | 11 |
| 7 | 1.1.1.2 9.1.3.4 | 3 12 | 15 |
| 8 | 1.2.2.2 9.1.5.1 | 13 3 | 16 |
| 9 | 5.2.1.1 9.1.5.1 | 17 3 | 20 |
| 10 | 7.2.2.1 9.1.3.2 | 6 6 | 12 |
| Total K = 175 (max K = 175) | | | |

A/C: _____

(signature/date)

FREE PROGRAM CHECK BY: _____



| | | | |
|----------|----------------------|------------------------------|----------------------------------|
| C | Contest: | Category: Advanced | |
| | Date: 2022 | Program: Known | Pilot's No. <input type="text"/> |

Pilot:

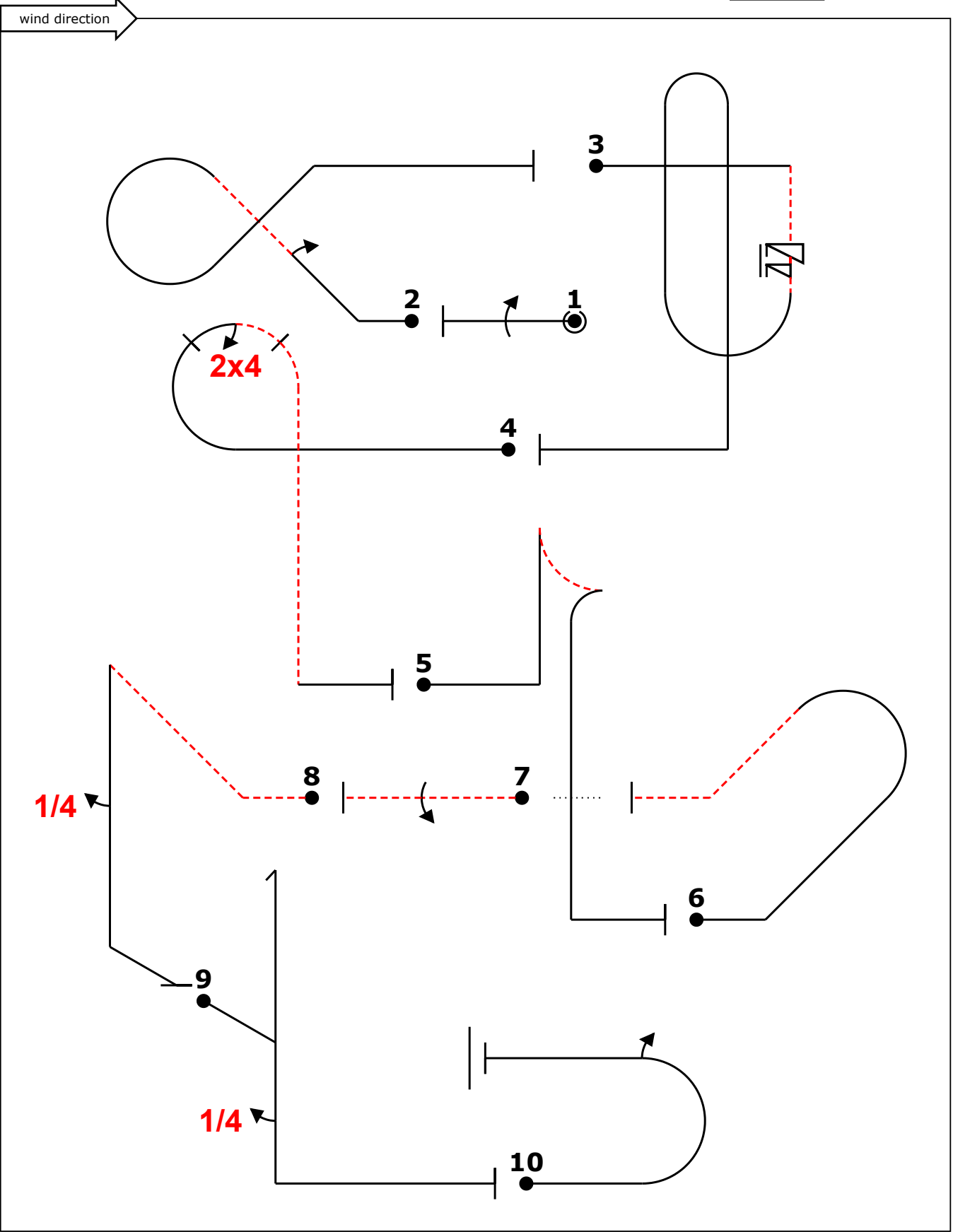

A/C:

(signature/date)

FREE PROGRAM CHECK BY: