

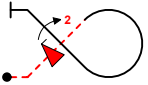





INTERNATIONAL AEROBATIC CLUB SCORESHEET

A	Contest:	Date:	Category: Unlimited	Programme: Unknown	pilot's number	

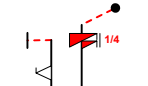
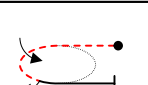
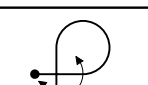
No	Symbol	Catalogue No.	K	Total K	Grade	Remarks
1		7.3.1.2 9.10.2.4 9.2.2.4	14 15 11	40		
2		8.4.17.3 9.2.4.4 9.1.2.4	11 9 10	30		
3		8.6.5.4 9.1.3.3 9.1.3.3 9.8.1.1	12 6 6 7	31		
4		8.4.1.4 9.12.1.5 9.9.1.2	13 6 15	34		
5		2.2.4.2	26	26		
6		8.6.5.1 9.1.3.4 9.1.5.1 9.1.5.3	11 8 2 6	27		
7		5.2.1.1 9.9.1.3 9.1.5.2	17 15 4	36		
8		6.2.1.1 9.4.1.3 9.1.5.4	15 12 8	35		
9		7.2.4.1 9.1.3.2 9.4.3.4 9.2.3.6	8 4 11 12	35		
10		1.2.7.4 9.1.2.4 9.9.2.2	14 10 13	37		
11		7.3.4.4 9.1.4.6 9.4.4.2	15 10 5	30		
12		7.2.1.1 9.1.3.2 9.1.3.2 9.1.3.4	6 4 4 8	22		
13		8.5.6.4 9.1.2.2	11 6	17		

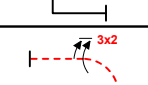
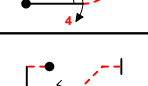
Presentation	20	
---------------------	-----------	--

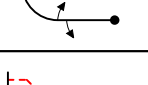
FIGURE TOTAL K = 400

INCLUDING PRESENTATION = 420

Aircraft Type:

FREE PROGRAM CHECKED BY:

Signature:	Printed Name:	Date:
		IAC No.

Judge Name:

IAC#

Assistant Name:

IAC#



Pilot NAC



B	Contest:	Category: Unlimited	
	Date:	Program: Unknown	Pilot's No. <input type="text"/>

Pilot
NAC

wind direction

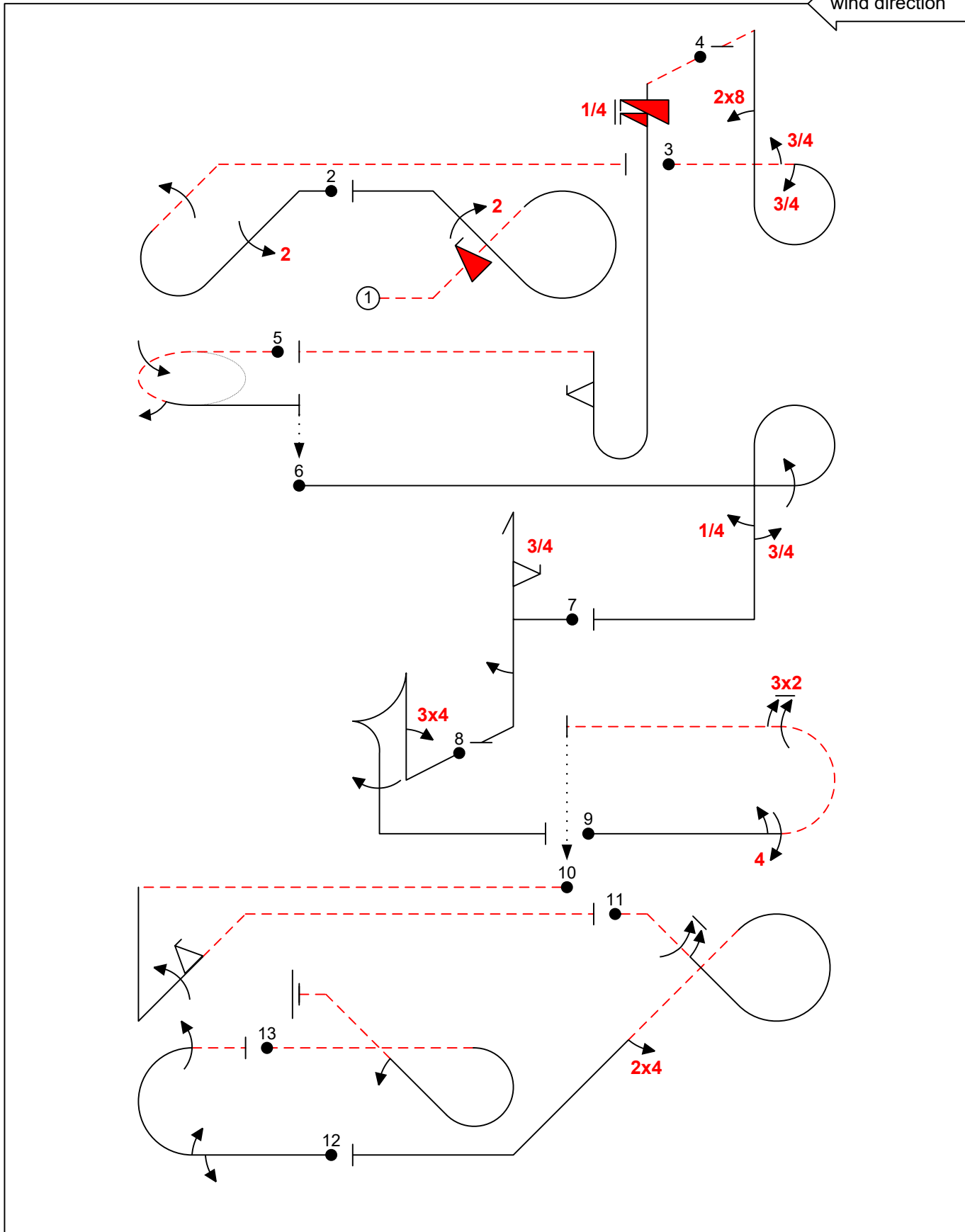

A/C: _____
FREE PROGRAM CHECK BY: (signature/date)



C	Contest:	Category: Unlimited	
	Date:	Program: Unknown	Pilot's No. <input type="text"/>

pilot
NAC

wind direction

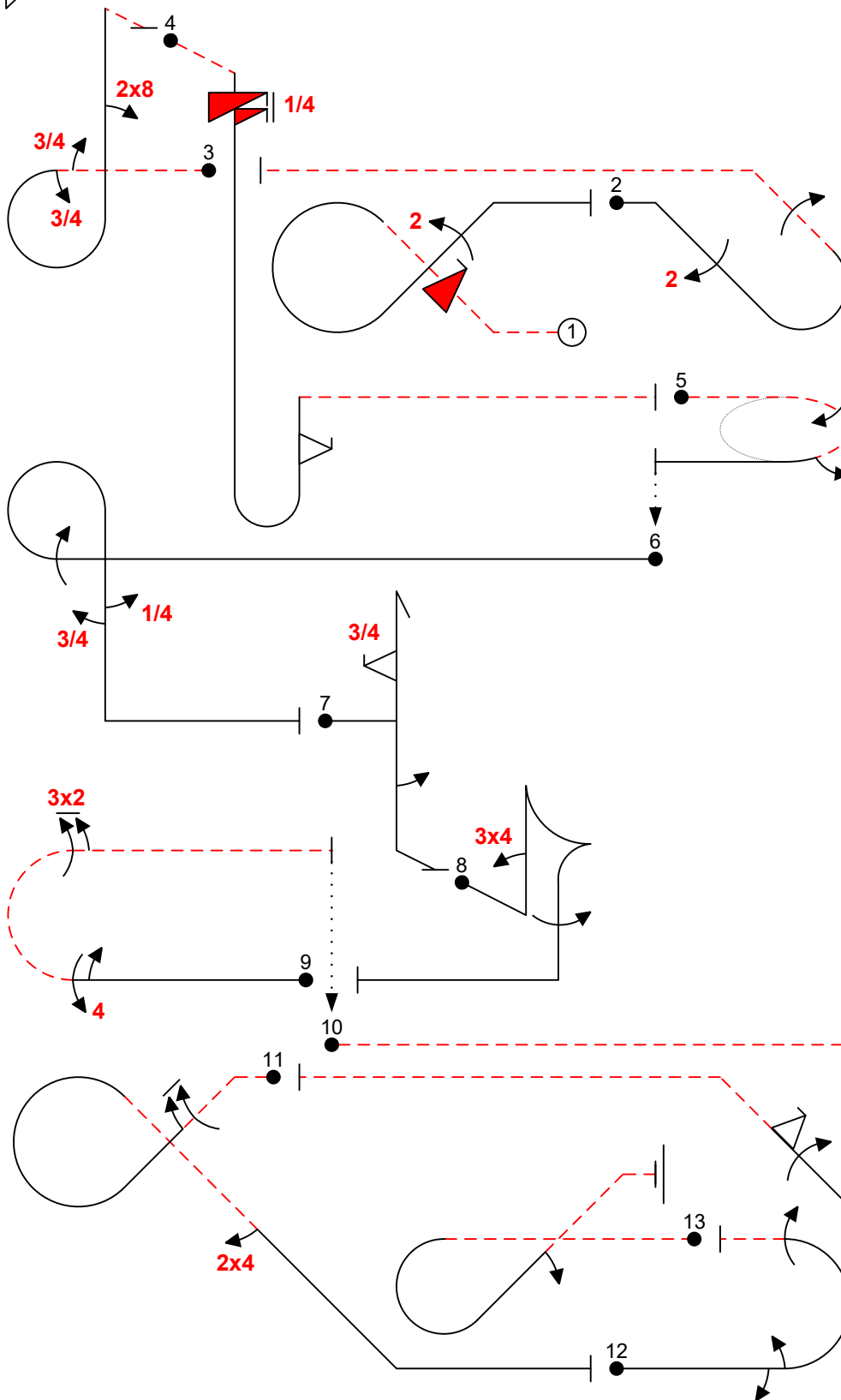

Created Using Aresti 2013™ software. ACCassidy@aol.com

A/C:

(signature/date)

FREE PROGRAM CHECK BY: