

INTERNATIONAL AEROBATIC CLUB SCORESHEET

A

Contest:	Date:	Category: Unlimited	Programme: Unknown	pilot's number	
----------	-------	-------------------------------	------------------------------	----------------	--

No	Symbol	Catalogue No.	K	Total K	Grade	Remarks	Item	K	Score		
1		7.2.1.4 9.4.3.4 9.1.3.6 9.1.3.2	6 11 10 4	31			Presentation	20			
2		5.2.1.1 9.9.1.3 9.1.5.1 9.1.5.2	17 15 2 4	38							
3		1.1.10.1 9.10.2.4	9 15	24							
4		1.1.7.4 9.12.1.5 9.1.5.2	9 6 4	19							
5		6.2.2.3 9.1.1.3 9.1.5.2	16 10 4	30							
6		5.3.2.4 9.1.2.2 9.1.1.1 9.9.5.3	21 6 6 11	44							
7		7.4.5.1 9.1.2.4 9.1.4.4	15 10 8	33							
8		8.4.3.1 9.9.1.4 9.1.5.1 9.1.5.3	15 15 2 6	38							
9		7.2.1.1 9.4.3.4 9.1.3.1 9.1.3.5	6 11 2 9	28							
10		2.3.3.4	38	38							
11		5.2.1.1 9.1.1.3 9.1.1.1 9.10.5.3	17 10 6 13	46							
12		8.5.2.1 9.1.2.2 9.10.2.4	10 6 15	31							

FIGURE TOTAL K =

INCLUDING PRESENTATION =

Aircraft Type:

FREE PROGRAM CHECKED BY:

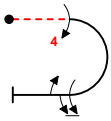
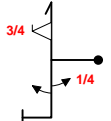
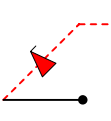
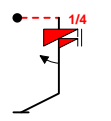
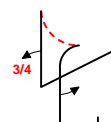
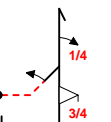
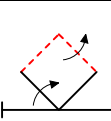
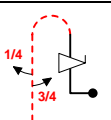
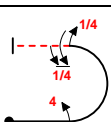
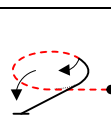
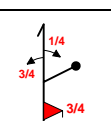
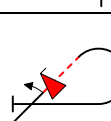
Signature:	Printed Name:	Date:
		IAC No.

Judge
Name
Number



pilot



B	Contest:	Category: Unlimited
Date:	Program: Unknown	Pilot's No. <input type="text"/>

wind direction

Pilot:

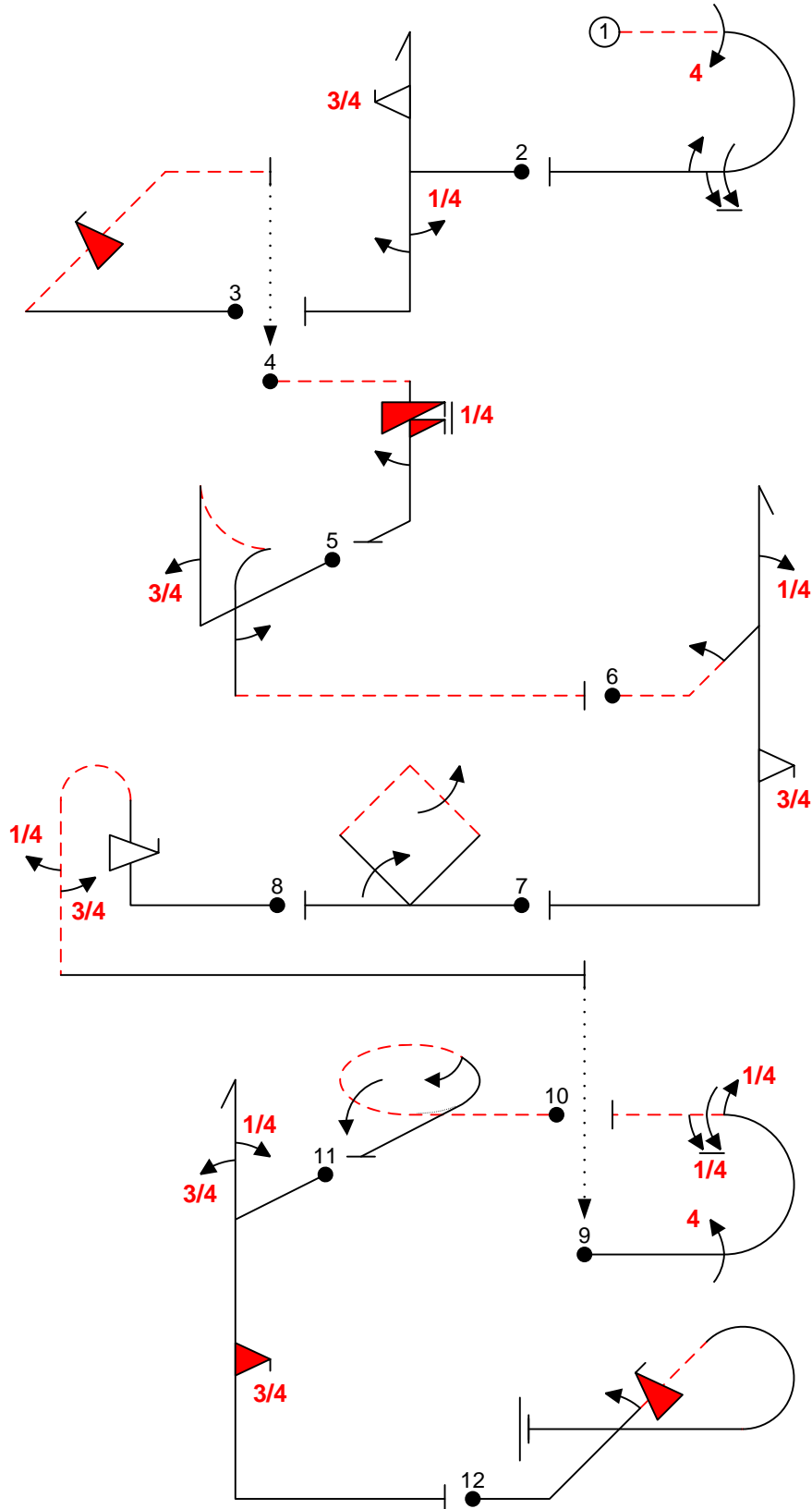

A/C:

(signature/date)

FREE PROGRAM CHECK BY:



C	Contest:	Category: Unlimited
	Date:	Program: Unknown

wind direction

Pilot:

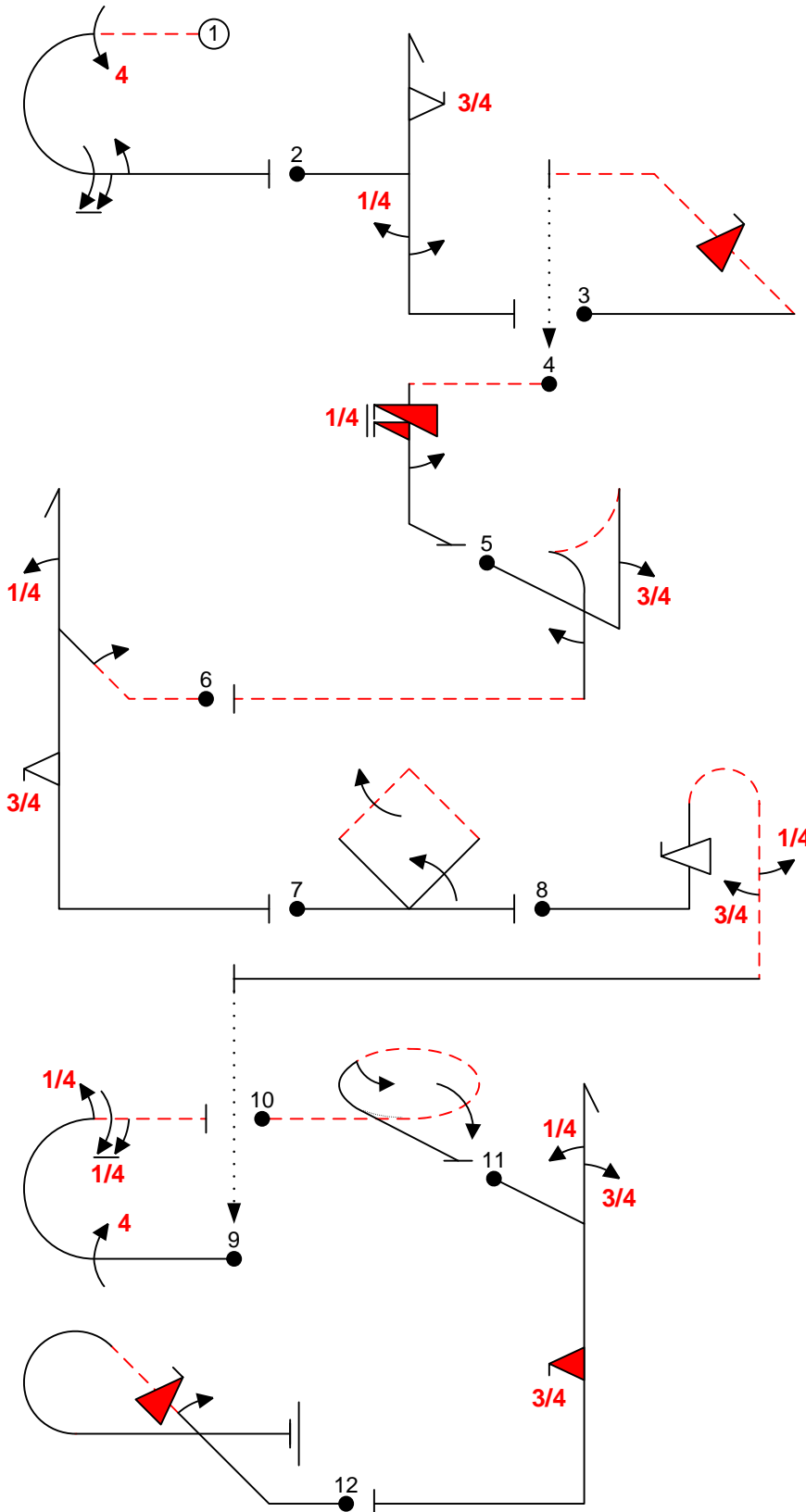

Created Using Aresti 2012™ software. ACCassidy@aol.com

A/C:

(signature/date)

FREE PROGRAM CHECK BY: