

INTERNATIONAL AEROBATIC CLUB SCORESHEET

A

Contest:

Date:

Category:

Programme:

pilot's number

Unlimited

Unknown



No	Symbol	Catalogue No.	K	Total K	Grade	Remarks	Item	K	Score		
1		8.52.1 9.8.3.2 9.4.3.4 9.1.5.4	15 7 11 8	41			Presentation	20			
2		8.2.1 9.9.1.3 9.1.5.3	14 15 6	35			FIGURE TOTAL K =		400		
3		1.7.2 9.1.1.2 9.1.1.3	12 8 10	30			INCLUDING PRESENTATION =		420		
4		2.17.1	24	24			Aircraft Type:				
5		8.39.4 9.12.1.5 9.4.5.2 9.1.3.2	12 6 5 4	27			FREE PROGRAM CHECKED BY:	Signature:	Printed Name:		
6		7.3.3 9.1.3.1 9.4.3.3 9.1.3.3 9.4.3.3	6 2 8 6 8	30						IAC No.	Date:
7		6.2.1 9.1.1.1 9.1.1.2 9.9.5.3	15 6 8 11	40							
8		5.1.3 9.4.1.3 9.10.5.2	18 12 13	43							
9		8.3.2 9.1.1.1 9.9.5.2	16 6 11	33							
10		8.17.2 9.4.2.2 9.1.2.2 9.1.4.4	11 7 6 8	32							
11		7.29.1 9.2.2.6 9.9.2.4	21 14 13	48							
12		7.4.2 9.1.3.2 9.8.3.2	6 4 7	17							

FIGURE TOTAL K = 400

INCLUDING PRESENTATION = 420

Aircraft Type:

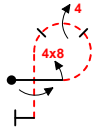
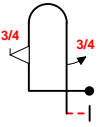
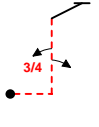
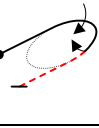
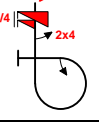
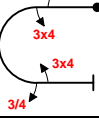
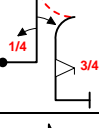
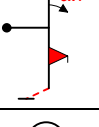
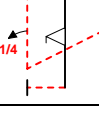
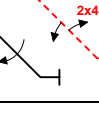
FREE PROGRAM CHECKED BY:

Signature:	Printed Name:	Date:
		IAC No.

Judge
Name
Number





B	Contest:	Category: Unlimited
Date:	Program: Unknown	Pilot's No. <input type="text"/>

wind direction

Pilot:

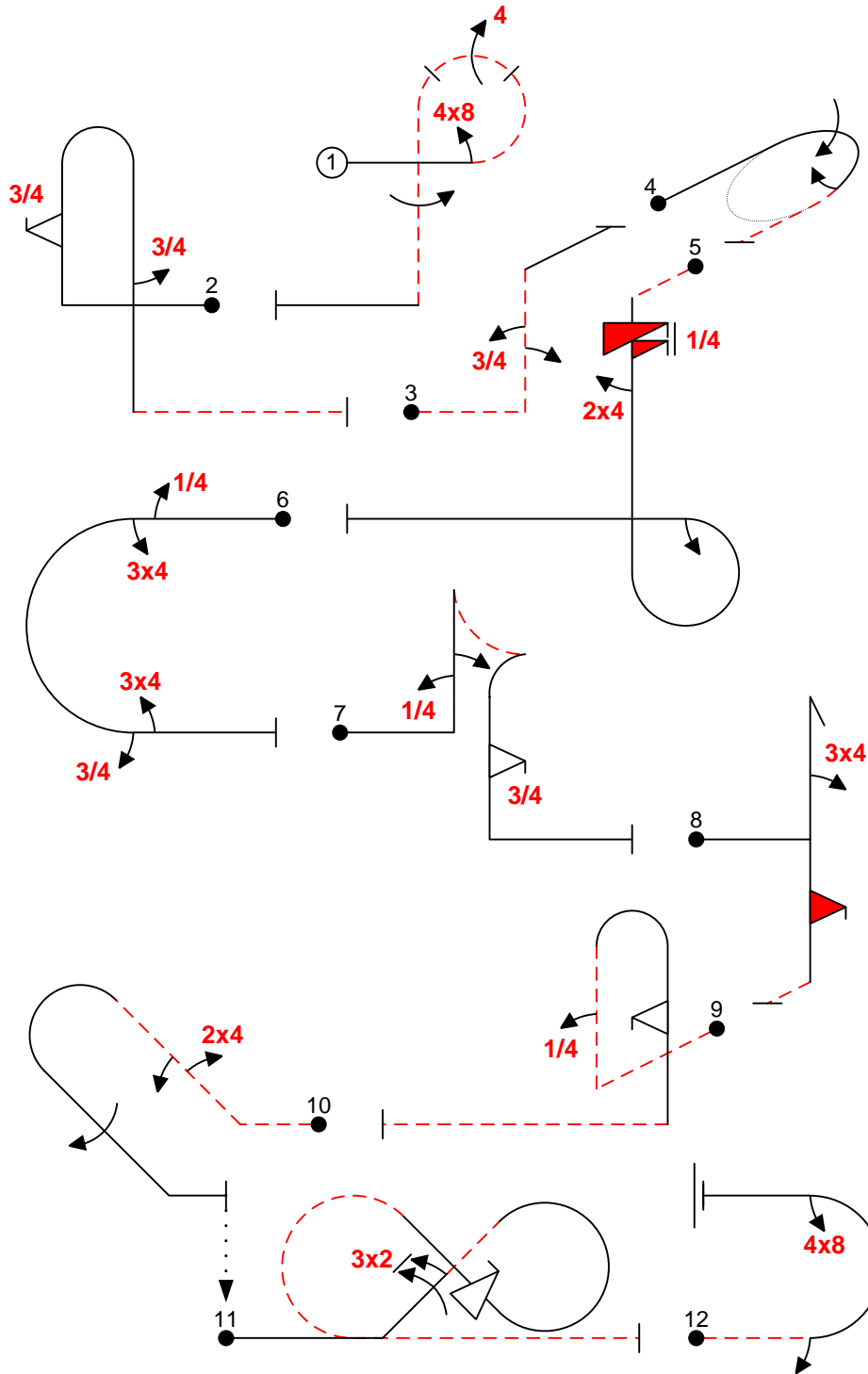

A/C:

(signature/date)

FREE PROGRAM CHECK BY:



C	Contest:	Category: Unlimited
Date:	Program: Unknown	Pilot's No. <input type="text"/>

wind direction

Pilot: _____

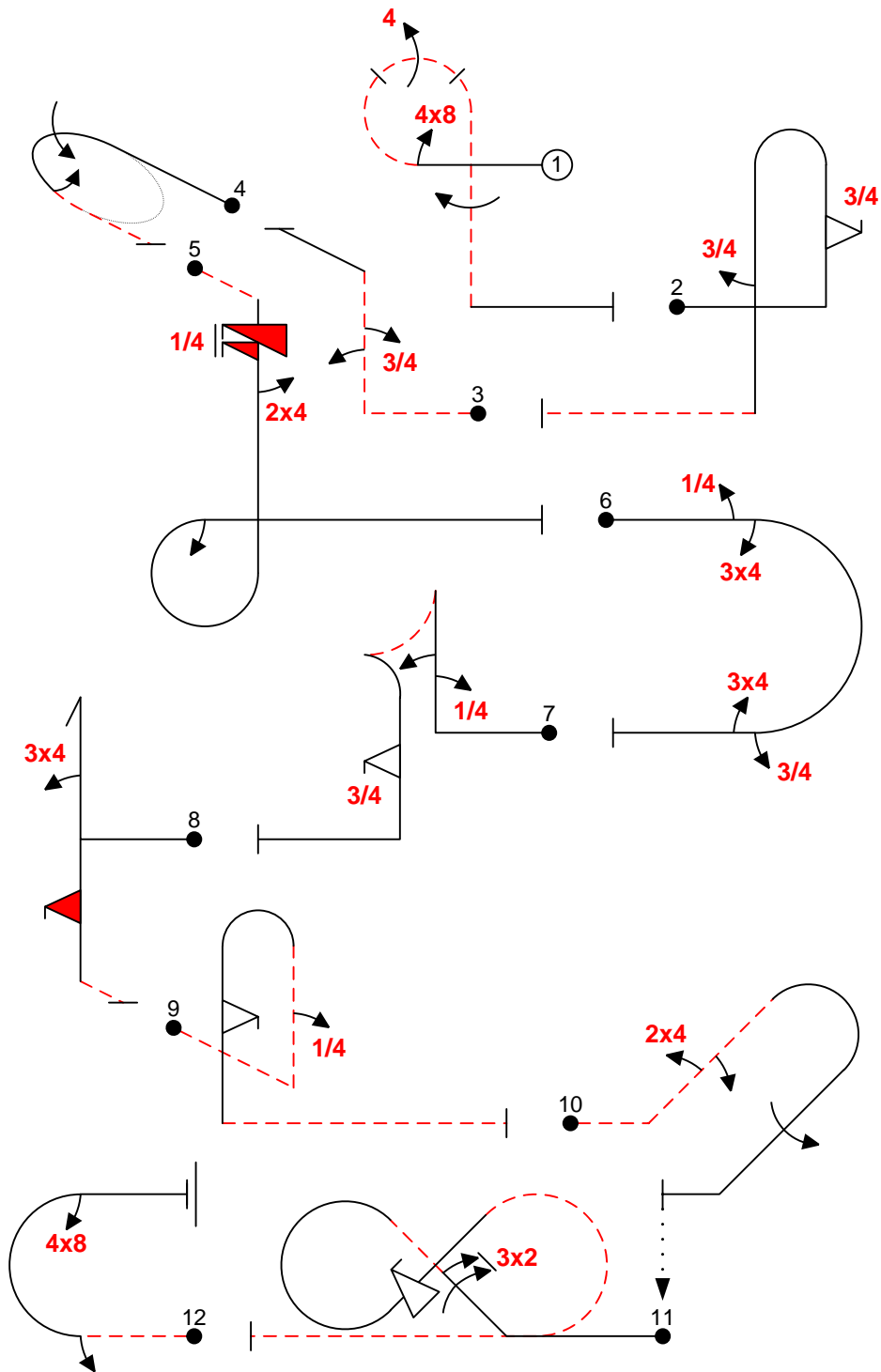

A/C: _____

(signature/date)

FREE PROGRAM CHECK BY: _____