

INTERNATIONAL AEROBATIC CLUB SCORESHEET

A

Contest:	Date:	Category: Unlimited	Programme: Unknown	pilot's number	
----------	-------	-------------------------------	------------------------------	----------------	--



No	Symbol	Catalogue No.	K	Total K	Score	Remarks	Item	K	Score
1		8.4.1 9.4.1.3 9.9.10.4	16 12 13	41			Presentation	20	
2		1.7.2 9.10.1.4	12 17	29					
3		1.6.3 9.11.1.5 9.9.5.2	10 4 11	25					
4		8.14.1 9.9.2.4 9.1.4.6	12 13 10	35					
5		6.1.3 9.1.1.3 9.1.5.3	16 10 6	32					
6		7.8.2 9.8.3.2	17 7	24					
7		9.1.1.4 9.4.3.4 8.40.1 9.1.3.2	12 11 14 4	41					
8		5.1.1 9.1.1.1 9.1.1.3 9.10.5.4	17 6 10 13	46					
9		1.11.1 9.4.2.2	9 7	16					
10		2.12.3	28	28					
11		8.41.1 9.2.4.4	10 9	19					
12		5.1.2 9.10.1.3 9.1.5.3	23 17 6	46					

FIGURE TOTAL K = **382**

INCLUDING PRESENTATION = **402**

Aircraft Type:

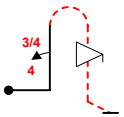
FREE PROGRAM CHECKED BY:

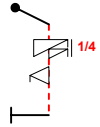
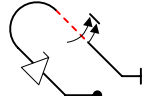
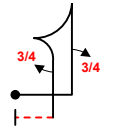
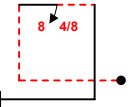
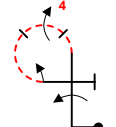
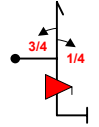
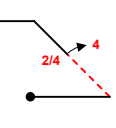
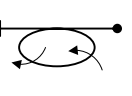
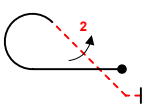
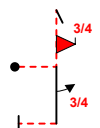
Signature:	Date:
	IAC No.

Judge
Name
Number



pilot



B	Contest:	Category: Unlimited
Date:	Program: Unknown	Pilot's No. <input type="text"/>

wind direction

Pilot:

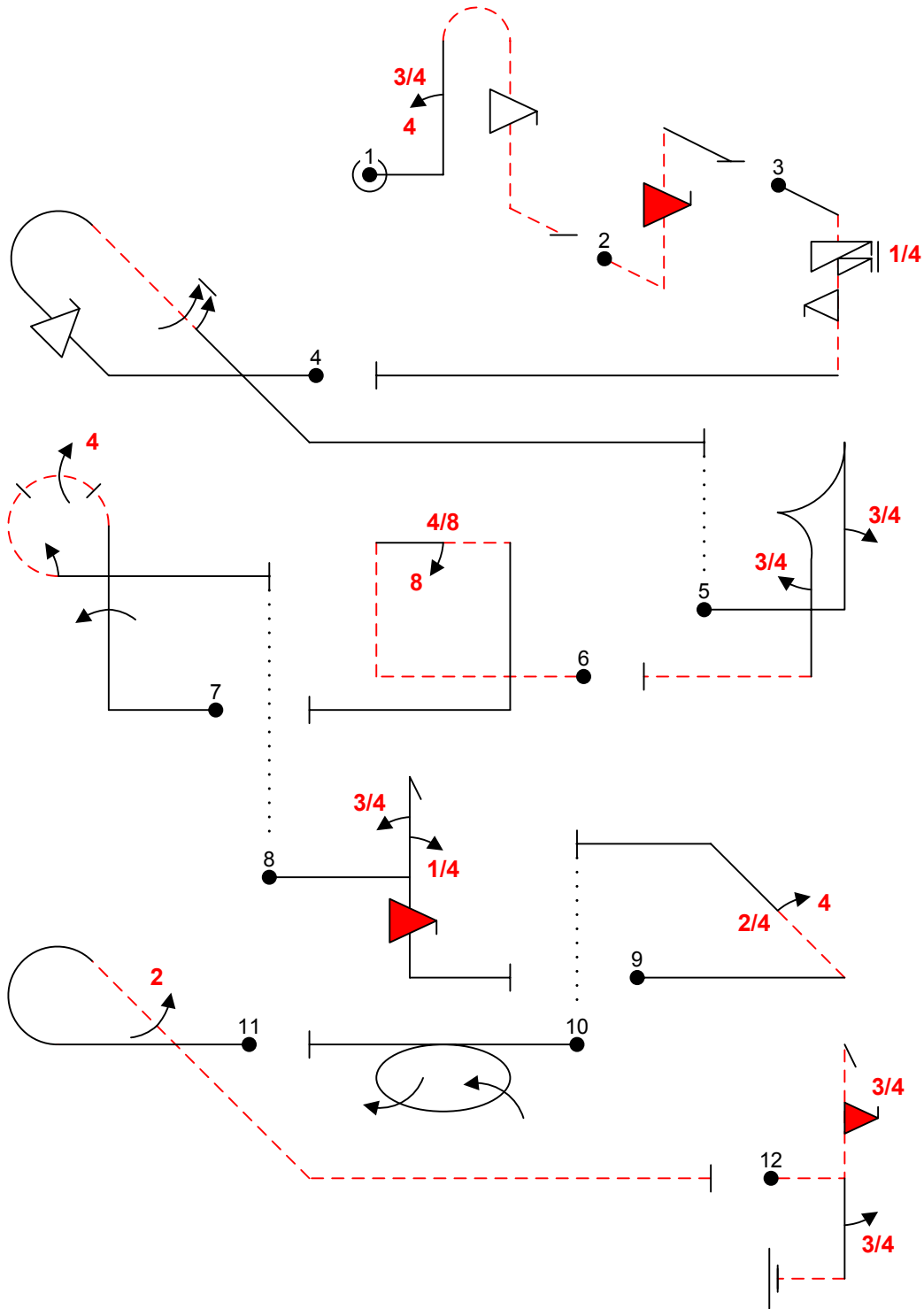

A/C:

(signature/date)

FREE PROGRAM CHECK BY:



C	Contest:	Category: Unlimited
Date:	Program: Unknown	Pilot's No. <input type="text"/>

wind direction

Pilot:

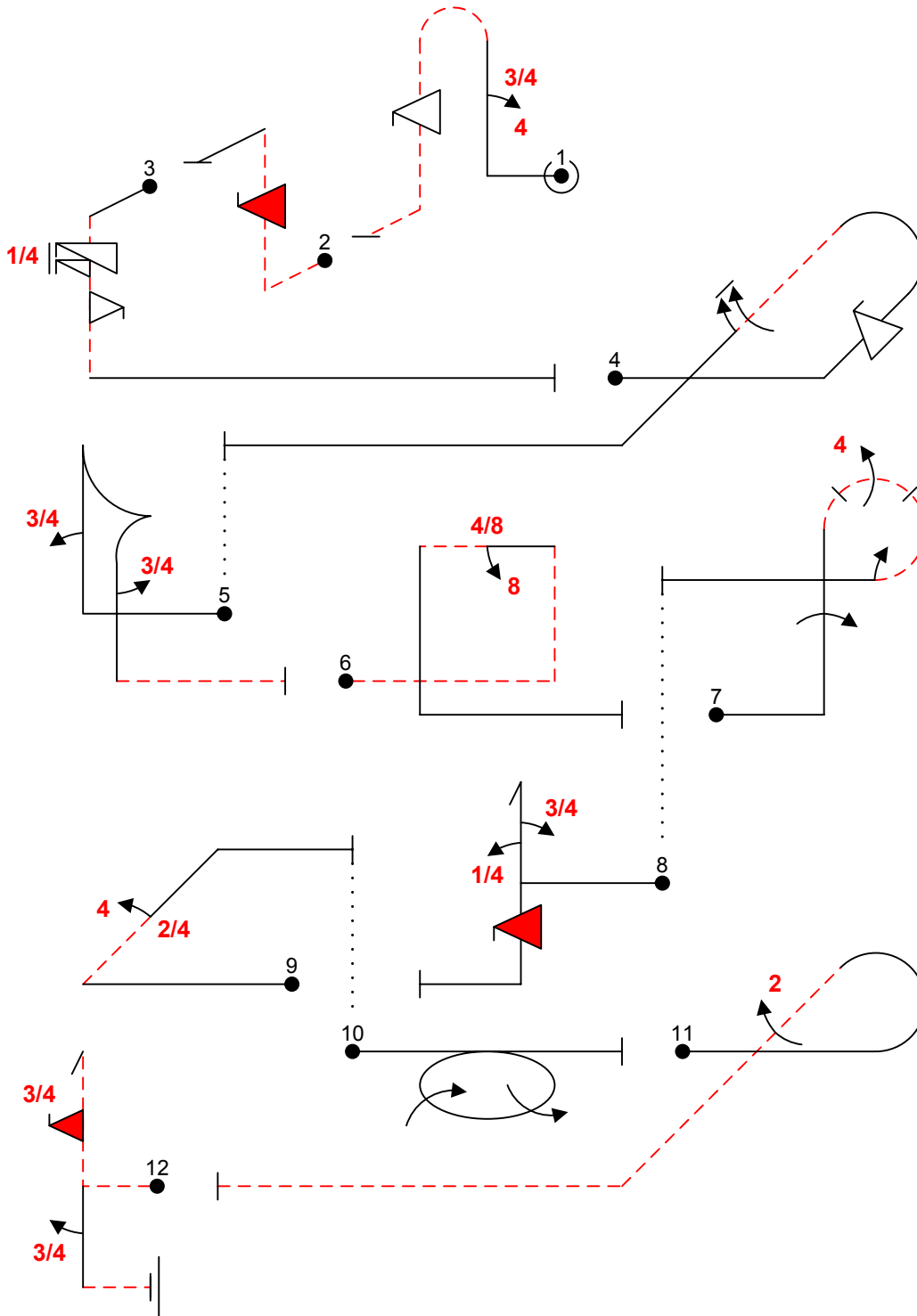

A/C:

(signature/date)

FREE PROGRAM CHECK BY: