

INTERNATIONAL AEROBATIC CLUB SCORESHEET

A

Contest:	Date:	Category: Unlimited	Programme: Unknown	pilot's number	
----------	-------	-------------------------------	------------------------------	----------------	--

No	Symbol	Catalogue No.	K	Total K	Score	Remarks	Item	K	Score		
1		8.4.1 9.1.1.5 9.9.10.3	16 14 13	43			Presentation	20			
2		1.2.2 9.10.2.4	8 15	23							
3		1.7.4 9.9.5.4	9 11	20							
4		7.9.1 9.2.2.4 9.9.9.4	15 11 13	39							
5		5.1.1 9.4.1.3 9.1.5.3	17 12 6	35							
6		6.1.1 9.4.1.4 9.2.5.4	15 15 9	39							
7		5.1.3 9.9.1.3 9.1.5.4	18 15 8	41							
8		8.1.2 9.1.1.4 9.10.5.3	18 12 13	43							
9		1.13.2 9.2.2.4 9.2.5.4	13 11 9	33							
10		8.33.1 9.2.1.4 9.1.1.2 9.4.3.4	11 13 8 11	43							
11		2.11.1	17	17							
12		1.1.1 9.8.3.4	2 15	17							

FIGURE TOTAL K = **393**

INCLUDING PRESENTATION = **413**

Aircraft Type:

FREE PROGRAM CHECKED BY:

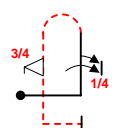
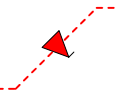
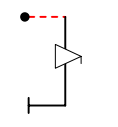
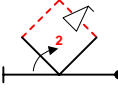
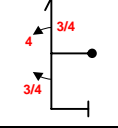
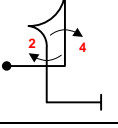
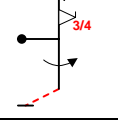
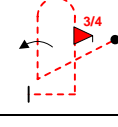
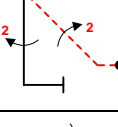
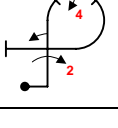
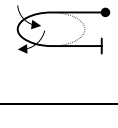
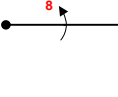
Signature:	Date:
	IAC No.

Judge
Name
Number



pilot



B	Contest:	Category: Unlimited
Date:	Program: Unknown	Pilot's No. <input type="text"/>

wind direction

Pilot:

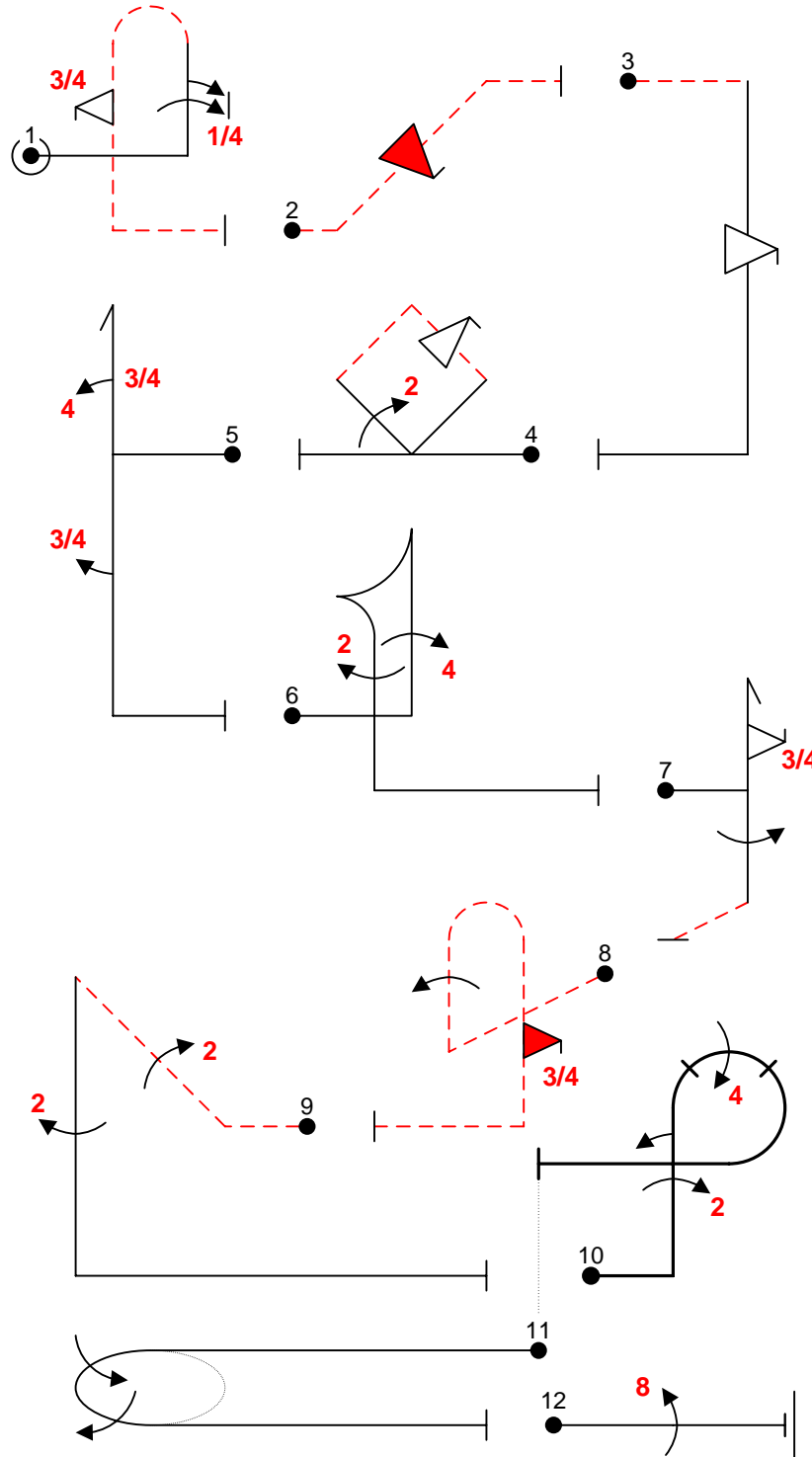

A/C:

(signature/date)

FREE PROGRAM CHECK BY:



C	Contest:	Category: Unlimited
Date:	Program: Unknown	Pilot's No. <input type="text"/>

wind direction

Pilot: _____

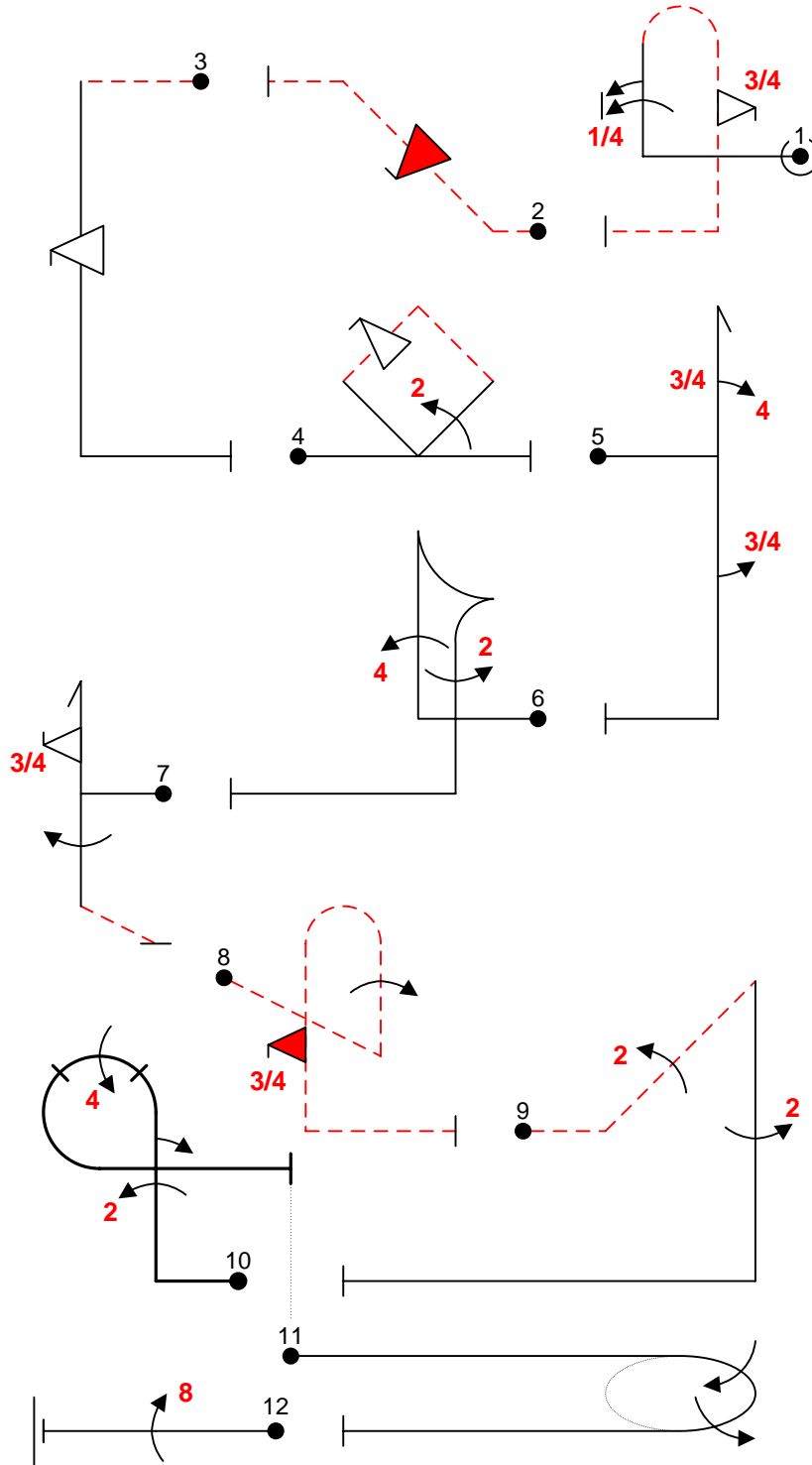

A/C: _____

(signature/date)

FREE PROGRAM CHECK BY: _____