

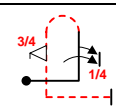

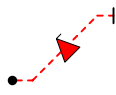
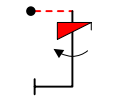
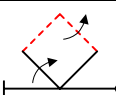
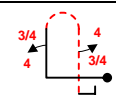
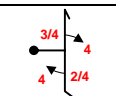
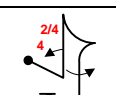
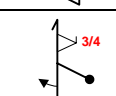
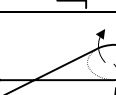

INTERNATIONAL AEROBATIC CLUB SCORESHEET

A	Contest:	Date:	Category:	Programme:	pilot's number	
			Unlimited	Unknown		

No	Symbol	Catalogue No.	K	Total K	Score	Remarks
1		8.4.1 9.1.1.5 9.9.10.3	16 14 13	43		
2		1.2.2 9.10.2.4	8 15	23		
3		1.7.4 9.12.1.4 9.1.5.4	9 7 8	24		
4		7.9.1 9.1.2.4 9.1.4.4	15 10 8	33		
5		8.3.1 9.4.1.3 9.4.5.3	15 12 8	35		
6		5.1.1 9.4.1.3 9.4.5.2	17 12 5	34		
7		6.1.1 9.4.1.2 9.1.5.4	15 9 8	32		
8		5.1.1 9.9.1.3 9.1.5.2	17 15 4	36		
9		2.8.3	19	19		
10		1.7.1 9.1.1.3	9 10	19		
11		7.1.4 9.10.3.4 9.8.3.4	6 13 15	34		
12		1.16.1 9.4.1.4 9.10.4.4	14 15 13	42		
13		2.11.2	18	18		
14						
15						
16						

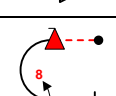
Presentation	20	
--------------	----	--

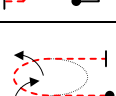
FIGURE TOTAL K = 392

INCLUDING POSITIONING = 412

Aircraft Type:

FREE PROGRAM CHECKED BY:

Signature:	Date:
IAC No.	

Judge
Name
Number





B	Contest:	Category: Unlimited
Date:	Program: Unknown	Pilot's No. <input type="text"/>

wind direction

Pilot:

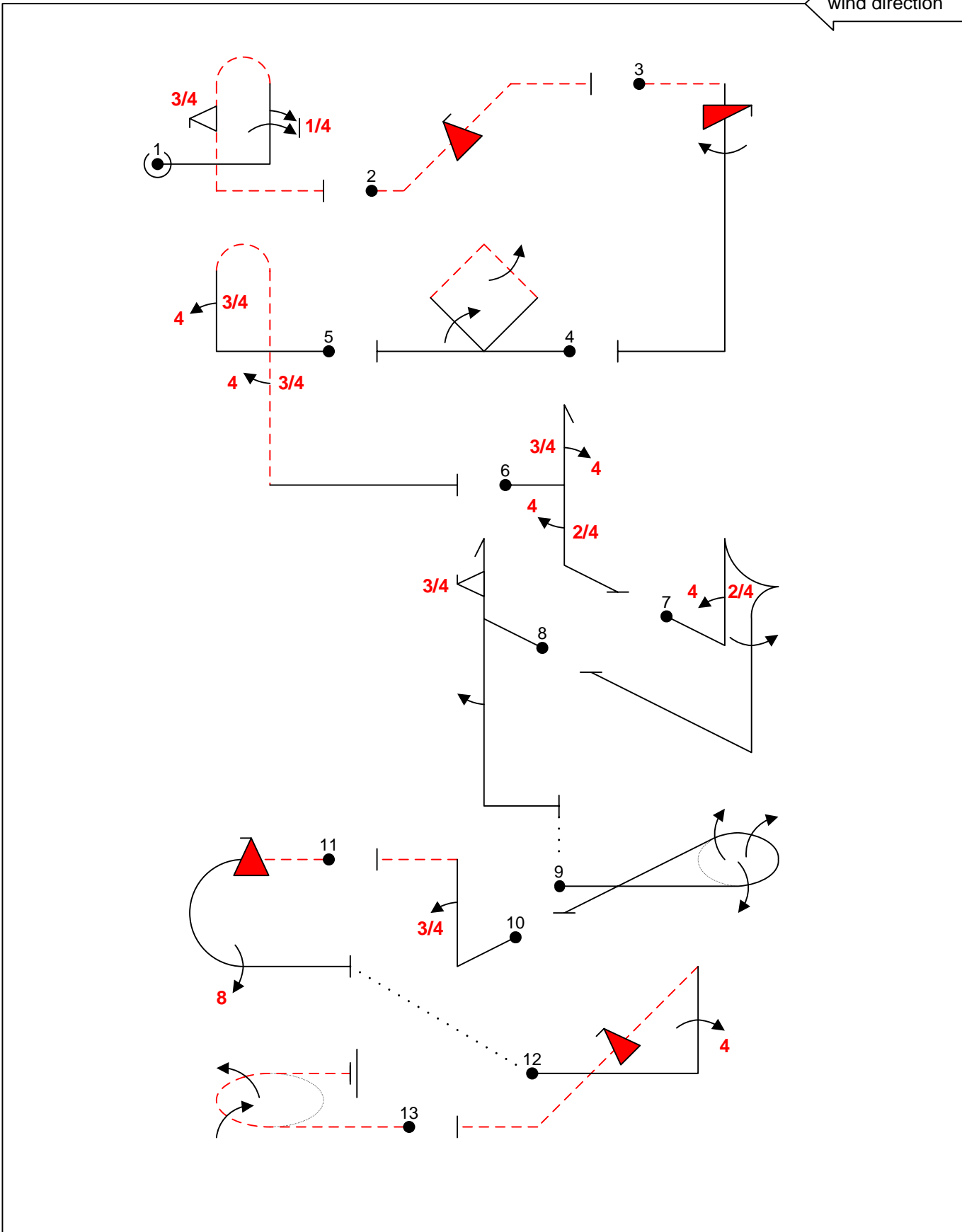

A/C:

(signature/date)

FREE PROGRAM CHECK BY:



C	Contest:	Category: Unlimited
Date:	Program: Unknown	Pilot's No. <input type="text"/>

wind direction

Pilot:

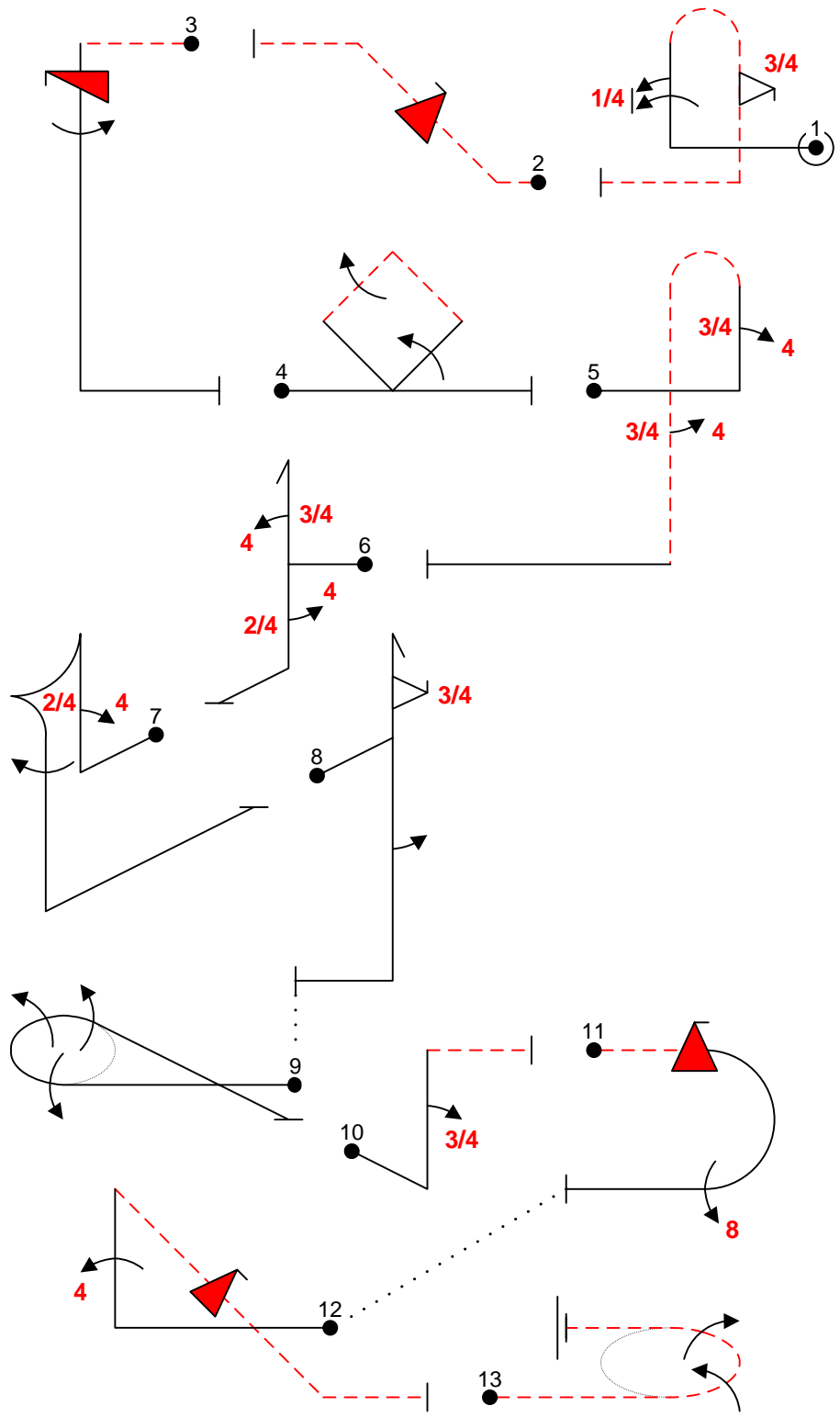

A/C:

(signature/date)

FREE PROGRAM CHECK BY: