

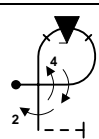

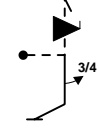
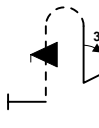

INTERNATIONAL AEROBATIC CLUB SCORESHEET

A	Contest:	Date:	Category: Unlimited	Programme: Unknown	pilot's number	

No	Symbol	Catalogue No.	K	Total K	Score	Remarks	Item	K	Score
1		8.44.1 9.4.3.4 9.1.3.4 9.10.8.4 9.2.5.4	12 11 8 15 9	55			Positioning	20	
2		5.1.4 9.10.1.4 9.1.5.3	22 17 6	45		FIGURE TOTAL K =		397	
3		8.3.1 9.1.1.3 9.10.5.4	15 10 13	38		INCLUDING POSITIONING =		417	
4		7.20.1 9.1.2.6 9.9.2.4	14 12 13	39		Aircraft Type:			
5		1.6.3 9.11.1.4 9.1.5.4	10 5 8	23		FREE PROGRAM CHECKED BY: Signature: _____ Date: _____ IAC No. _____			
6		6.2.1 9.4.1.2 9.1.5.3	15 9 6	30					
7		5.1.3 9.1.5.1	18 2	20					
8		7.2.2 9.2.3.4 9.10.3.6 9.1.3.4	9 9 16 8	42					
9		8.44.4 9.8.3.2 9.9.3.2 9.1.1.1	13 7 11 6	37					
10		2.8.3	19	19					
11		8.47.1 9.4.3.2 9.2.4.4	12 5 9	26					
12		7.9.1 9.1.4.4	15 8	23					

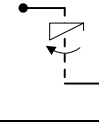
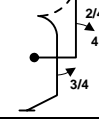
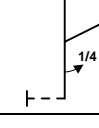
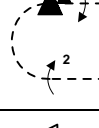
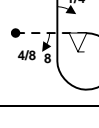
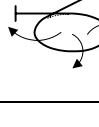
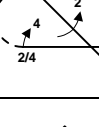
Judge	
Name	
Number	



pilot



B	Contest:	Category: Unlimited
Date:	Program: Unknown	Pilot's No. <input type="text"/>

wind direction

Pilot:

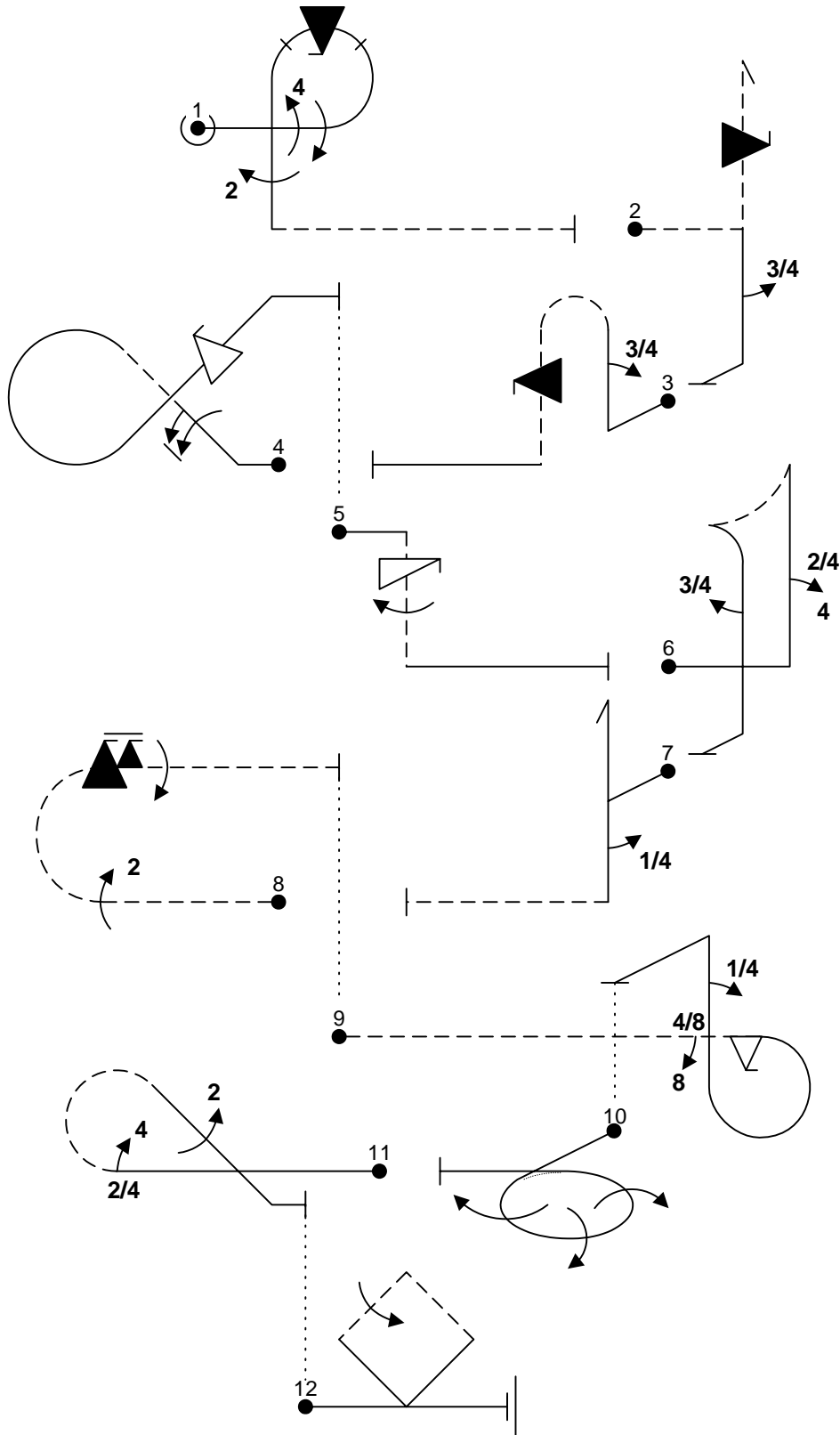

A/C:

(signature/date)

FREE PROGRAM CHECK BY:



C	Contest:	Category: Unlimited
Date:	Program: Unknown	Pilot's No. <input type="text"/>

wind direction

Pilot:

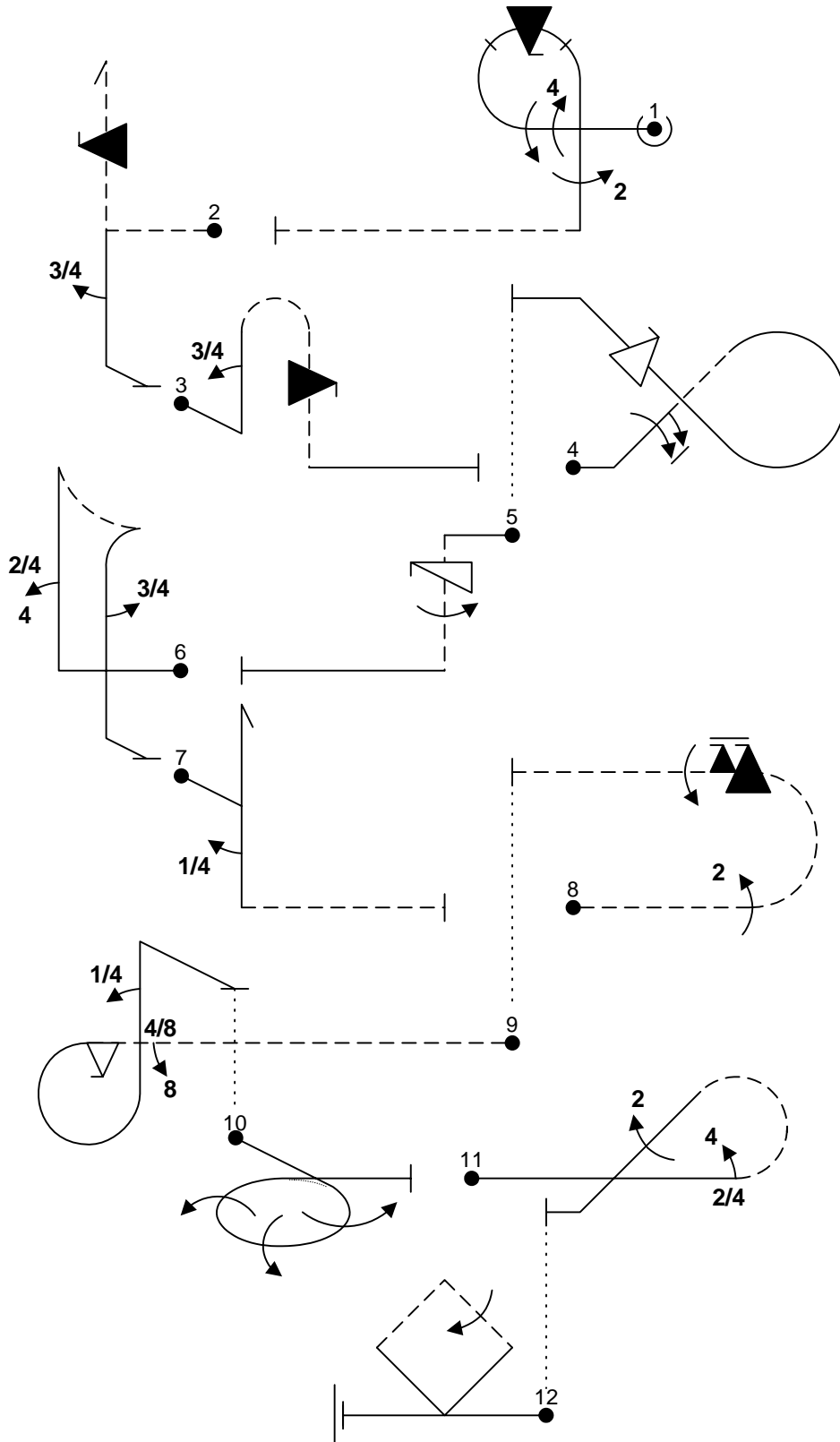

A/C:

(signature/date)

FREE PROGRAM CHECK BY: