

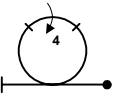



A INTERNATIONAL AEROBATIC CLUB SCORESHEET					Contest:			Date:		Category		Programme		pilot's number	
										Unlimited		Unknown			
No	Symbol	Catalog No	K	Tot. K	Score	Remarks	No	Symbol	Catalog No	K	Tot. K	Score	Remarks		
1		7.5.1 9.4.3.4	10 11	21			13		6.1.1 9.1.1.4	15 12	27				
2		1.10.1 9.2.2.4	9 11	20			14								
3		1.7.4 9.12.1.4	9 7	16			15								
4		8.15.1 9.8.2.2 9.10.9.4	12 9 15	36			16								
5		7.2.1 9.2.3.4 9.1.3.4 9.1.3.6	6 9 8 10	33			17								
6		5.1.1 9.4.1.4 9.2.5.4	17 15 9	41			18								
7		8.1.1 9.4.1.3 9.1.5.2	13 12 4	29			POSITIONING					20			
8		5.1.1 9.9.1.3 9.4.5.2	17 15 5	37			FIGURE TOTAL K =					367			
9		7.1.1 9.4.3.4 9.8.3.4	6 11 15	32			INCLUDING POSITIONING =					387			
10		2.8.4	20	20			JUDGE'S NAME								
11		8.4.4 9.9.5.2 9.4.1.3	16 11 12	39			JUDGE'S NUMBER								
12		7.3.3 9.1.3.6	6 10	16			FREE PROGRAM CHECKED BY:								
							AIRCRAFT TYPE								



pilot's name
(print)

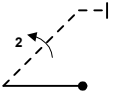
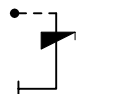

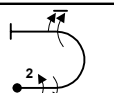
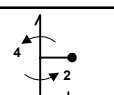
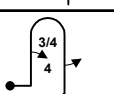
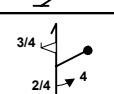
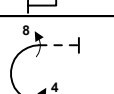
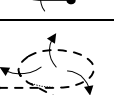
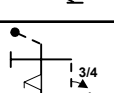
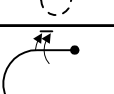
B	Contest:		Category:	Unlimited	
Date:		Prog:	Unknown	pilot's number	

wind direction

Pilot:

NOTE DOWNWIND START

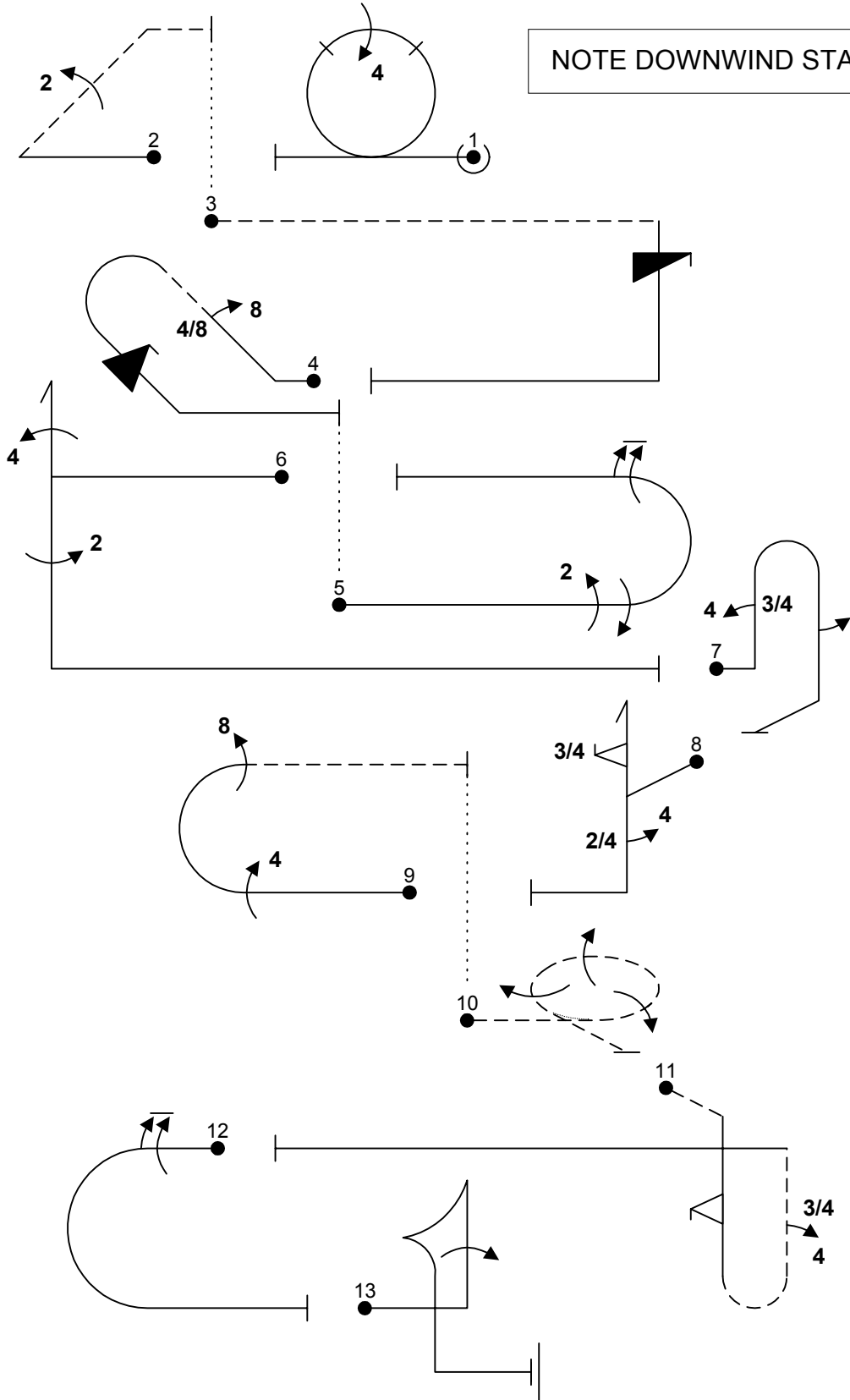

A/C:

(signature/date)

FREE PROGRAM CHECK BY:



C	Contest:		Category:	Unlimited	
Date:		Prog:	Unknown	pilot's number	

wind direction

NOTE DOWNWIND START

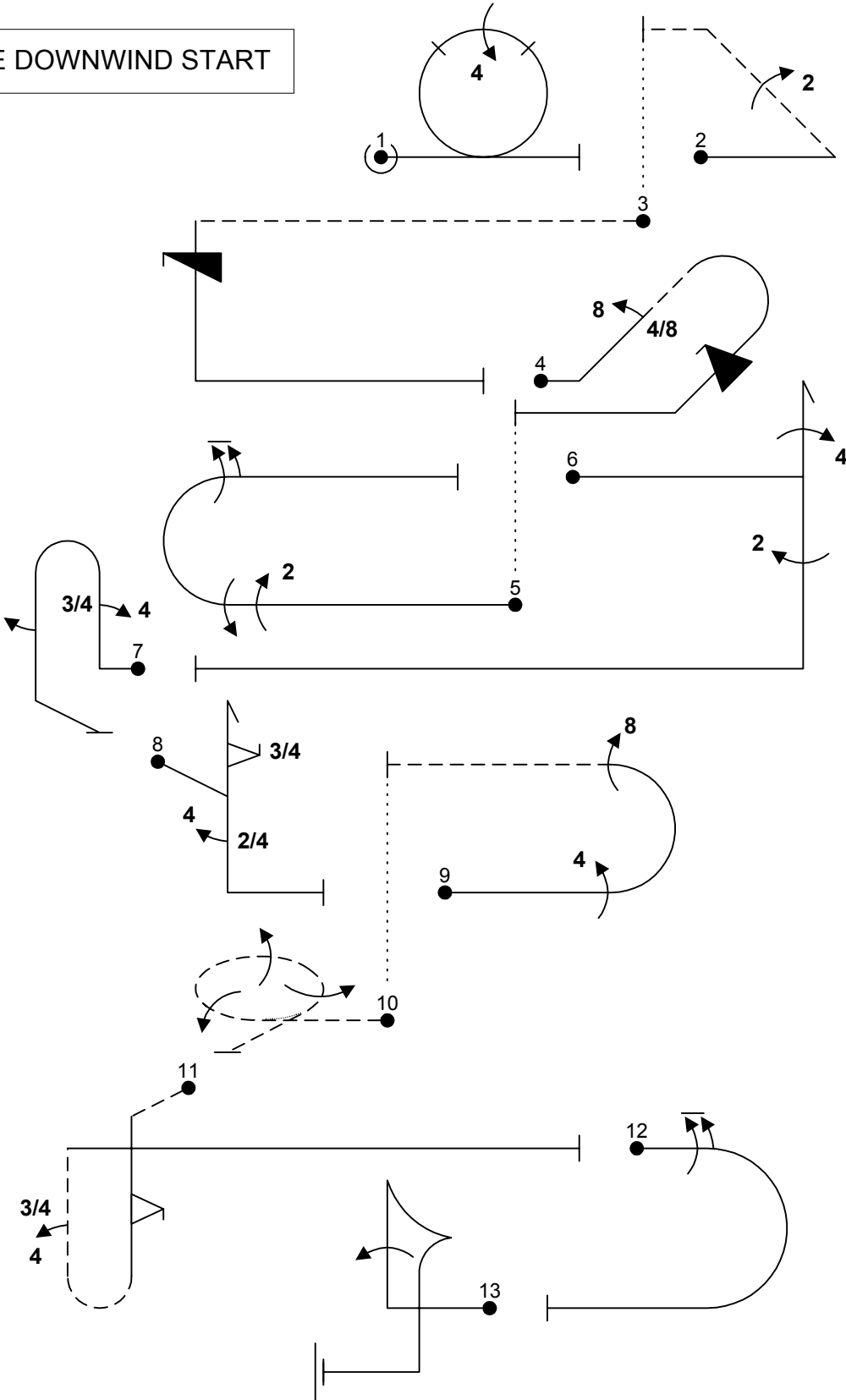

Pilot:

A/C:

(signature/date)

FREE PROGRAM CHECK BY: