

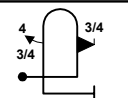





INTERNATIONAL AEROBATIC CLUB SCORESHEET					Contest:			Date:		Category		Programme		pilot's number	
										Unlimited		Unknown			
No	Symbol	Catalog No	K	Tot. K	Score	Remarks	No	Symbol	Catalog No	K	Tot. K	Score	Remarks		
1		8.1.1 9.10.1.3 9.4.5.3	13 17 8	38			13		1.3.3 9.9.4.6	8 14	22				
2		1.14.1 9.1.2.6 9.2.5.4	12 12 9	33			14								
3		7.5.1 9.4.3.4	10 11	21			15								
4		7.2.1 9.2.3.4 9.9.3.2 9.1.3.4	6 9 11 8	34			16								
5		6.2.3 9.1.1.1 9.1.5.3	16 6 6	28			17								
6		1.19.2 9.4.1.2 9.8.4.2	15 9 7	31			18								
7		1.7.1 9.9.1.3	9 15	24			POSITIONING					20			
8		2.8.4	20	20			FIGURE TOTAL K =					382			
9		5.1.4 9.1.1.2 9.1.5.4	22 8 8	38			INCLUDING POSITIONING =					402			
10		8.34.1 9.1.1.4 9.2.3.4	15 12 9	36			JUDGE'S NAME								
11		7.1.4 9.1.3.2 9.9.3.2	6 4 11	21			JUDGE'S NUMBER								
12		7.21.1 9.4.2.4 9.1.2.2	17 13 6	36			FREE PROGRAM CHECKED BY:								
							AIRCRAFT TYPE								

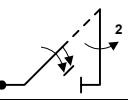
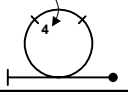
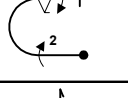
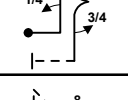

pilot's name
(print)

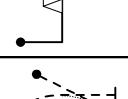
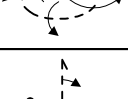
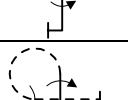
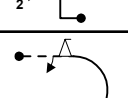
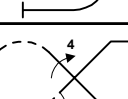

B	Contest:		Category:	Unlimited	
Date:		Prog:	Unknown	pilot's number	

wind direction

Pilot:

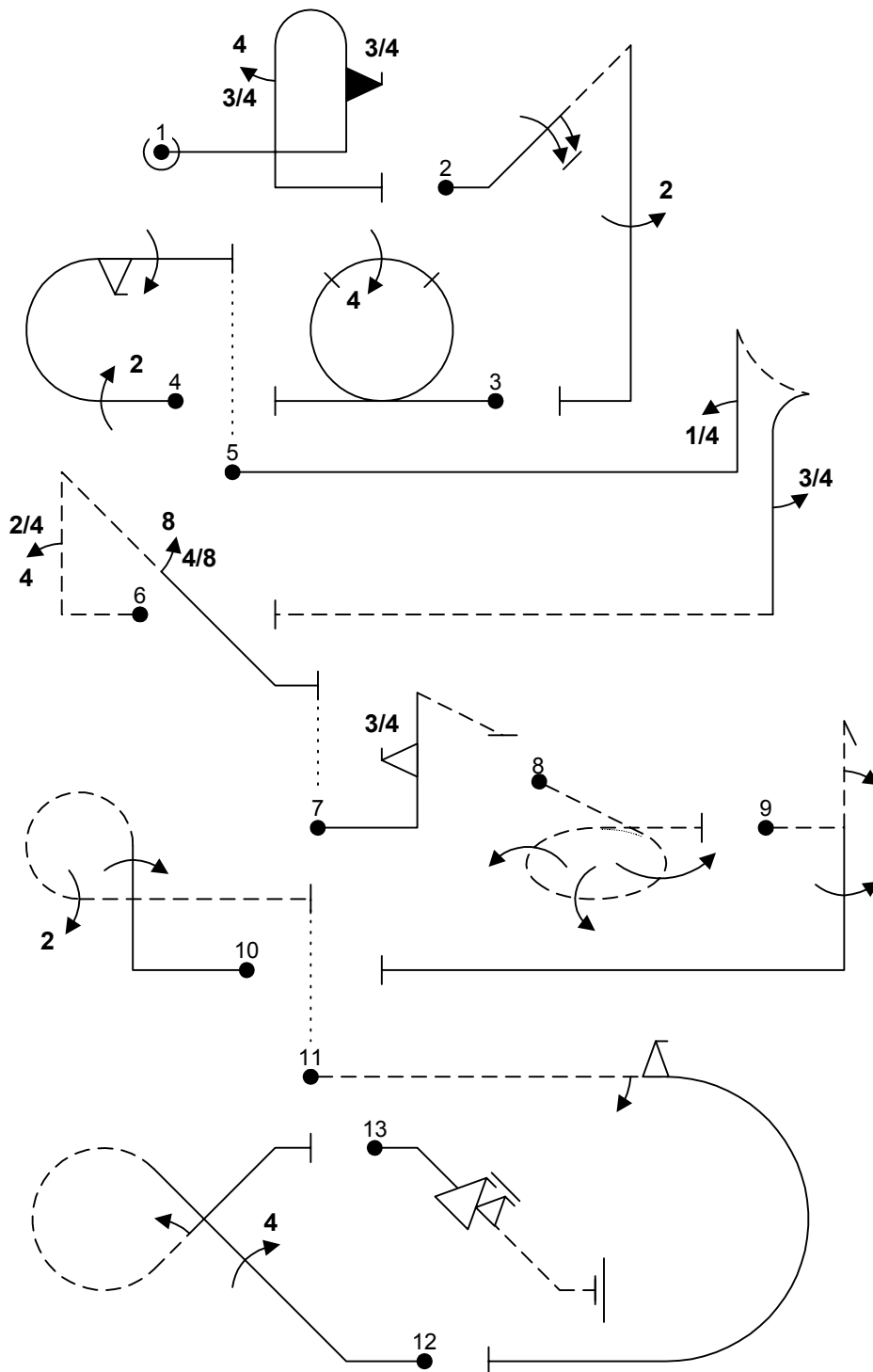

A/C:

(signature/date)

FREE PROGRAM CHECK BY:



C	Contest:		Category:	Unlimited	
Date:		Prog:	Unknown	pilot's number	

Pilot:

wind direction

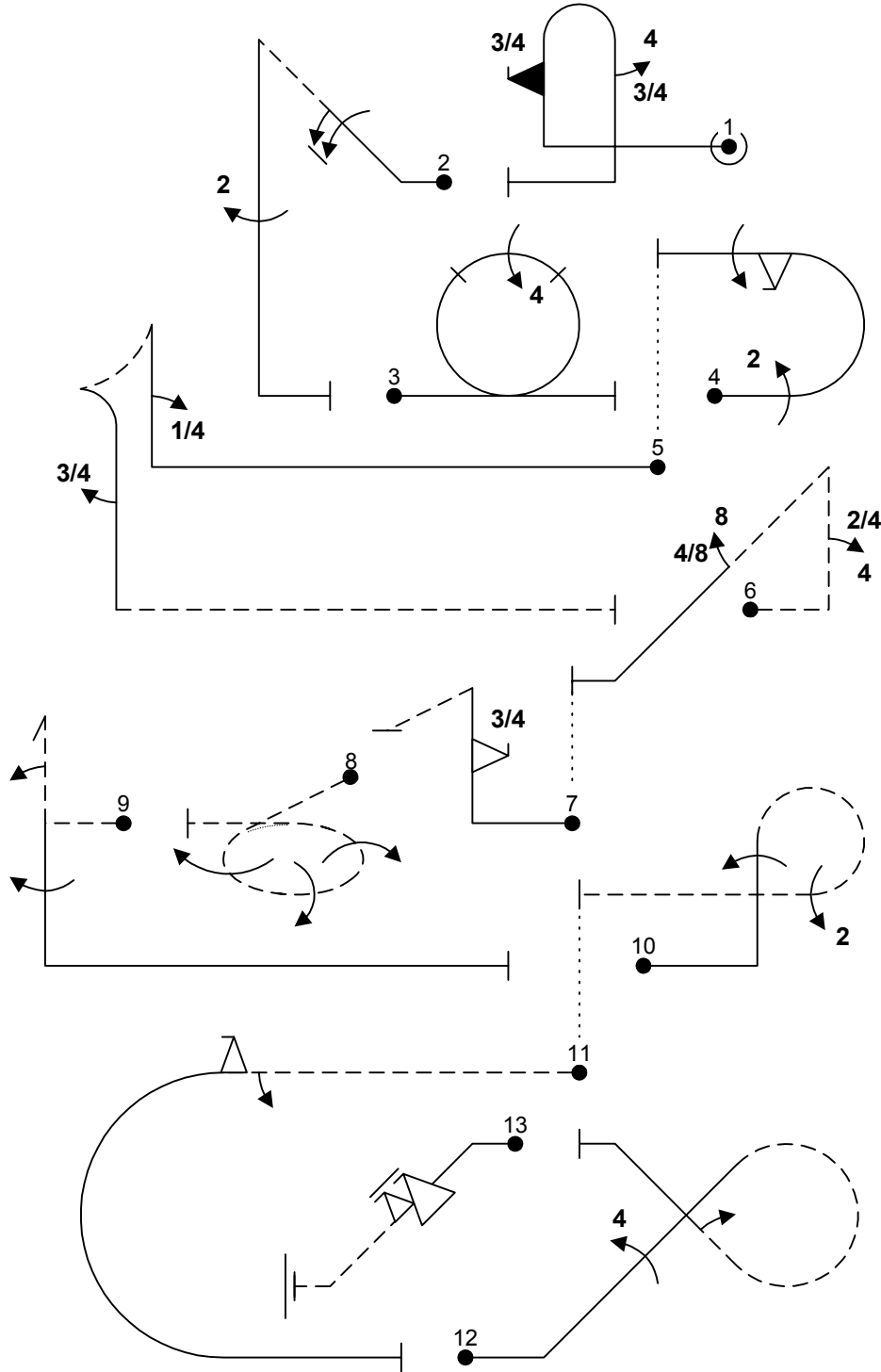

A/C:

(signature/date)

FREE PROGRAM CHECK BY: