

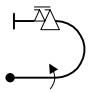

A INTERNATIONAL AEROBATIC CLUB SCORESHEET					Contest:			Date:		Category		Programme		pilot's number	
										Unlimited		Unknown			
No	Symbol	Catalog No	K	Tot. K	Score	Remarks		No	Symbol	Catalog No	K	Tot. K	Score	Remarks	
1		7.2.1 9.1.3.4 9.9.3.6	6 8 14	28				13		7.5.1 9.4.3.4	10 11	21			
2		1.7.3 9.2.5.4	11 9	20				14							
3		8.15.2 9.8.2.2 9.1.4.4	16 9 8	33				15							
4		7.2.2 9.4.3.4 9.9.8.2	9 11 13	33				16							
5		1.7.4 9.1.5.3	9 6	15				17							
6		5.1.1 9.9.1.3 9.1.5.2	17 15 4	36				18							
7		8.1.1 9.1.1.4 9.10.10.2	13 12 15	40				POSITIONING				20			
8		6.2.1 9.4.1.3 9.8.5.1	15 12 3	30				FIGURE TOTAL K =				372			
9		7.1.1 9.1.3.4 9.9.3.4	6 8 11	25				INCLUDING POSITIONING =				392			
10		2.7.2	25	25				JUDGE'S NAME							
11		5.1.4 9.8.5.2	22 7	29				JUDGE'S NUMBER							
12		8.3.1 9.4.1.2 9.10.5.4	15 9 13	37				FREE PROGRAM CHECKED BY:							
								AIRCRAFT TYPE							

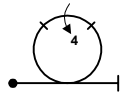

pilot's name  
(print)

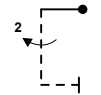
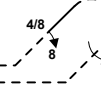
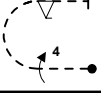
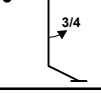
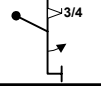
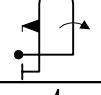
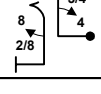
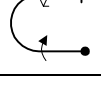
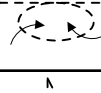
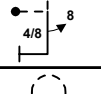

<b>B</b>	Contest:		Category:	Unlimited	
Date:		Prog:	Unknown	pilot's number	

wind direction

Pilot:

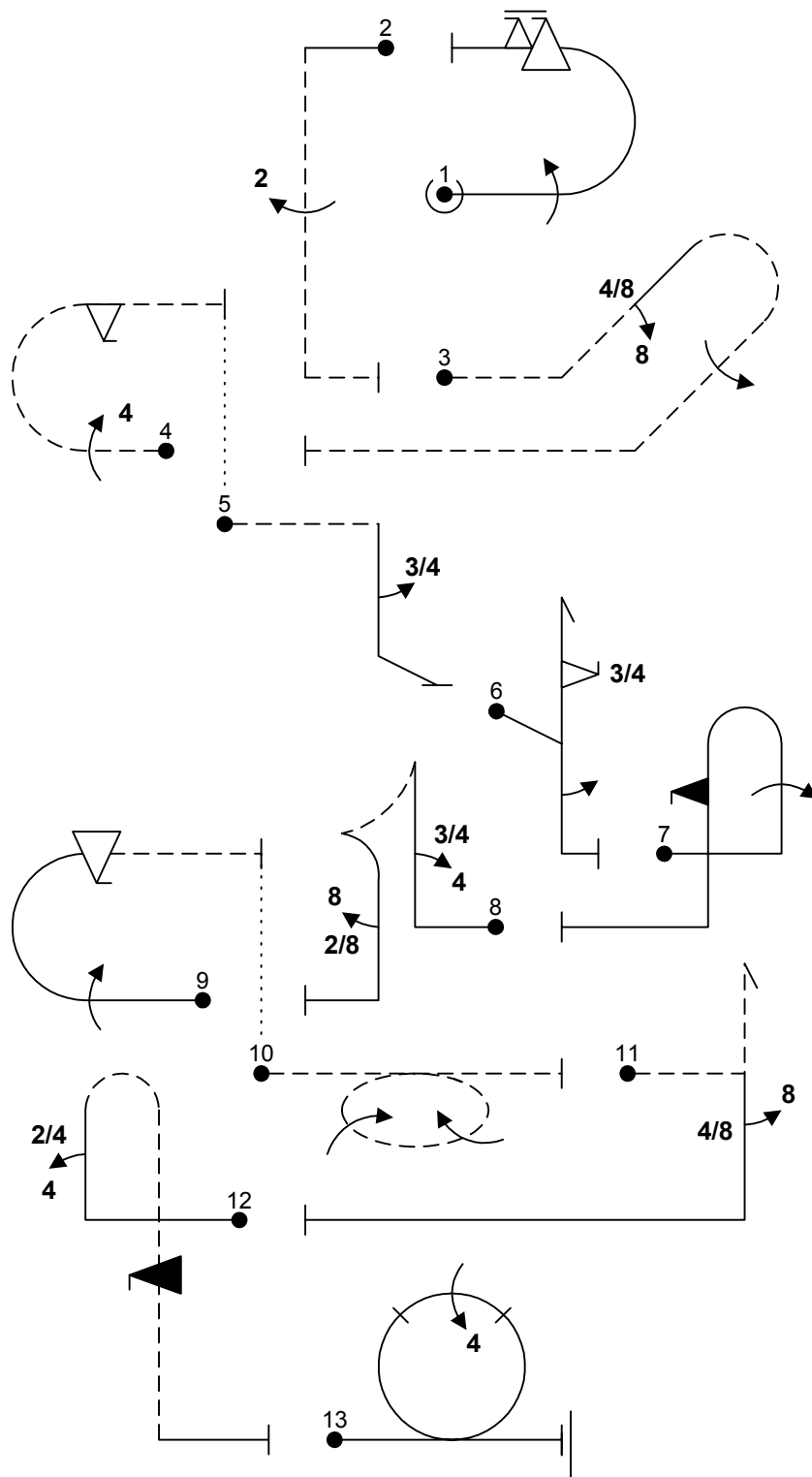

A/C:

(signature/date)

FREE PROGRAM CHECK BY:



<b>C</b>	Contest:		Category:	Unlimited	
Date:		Prog:	Unknown	pilot's number	

Pilot:

wind direction

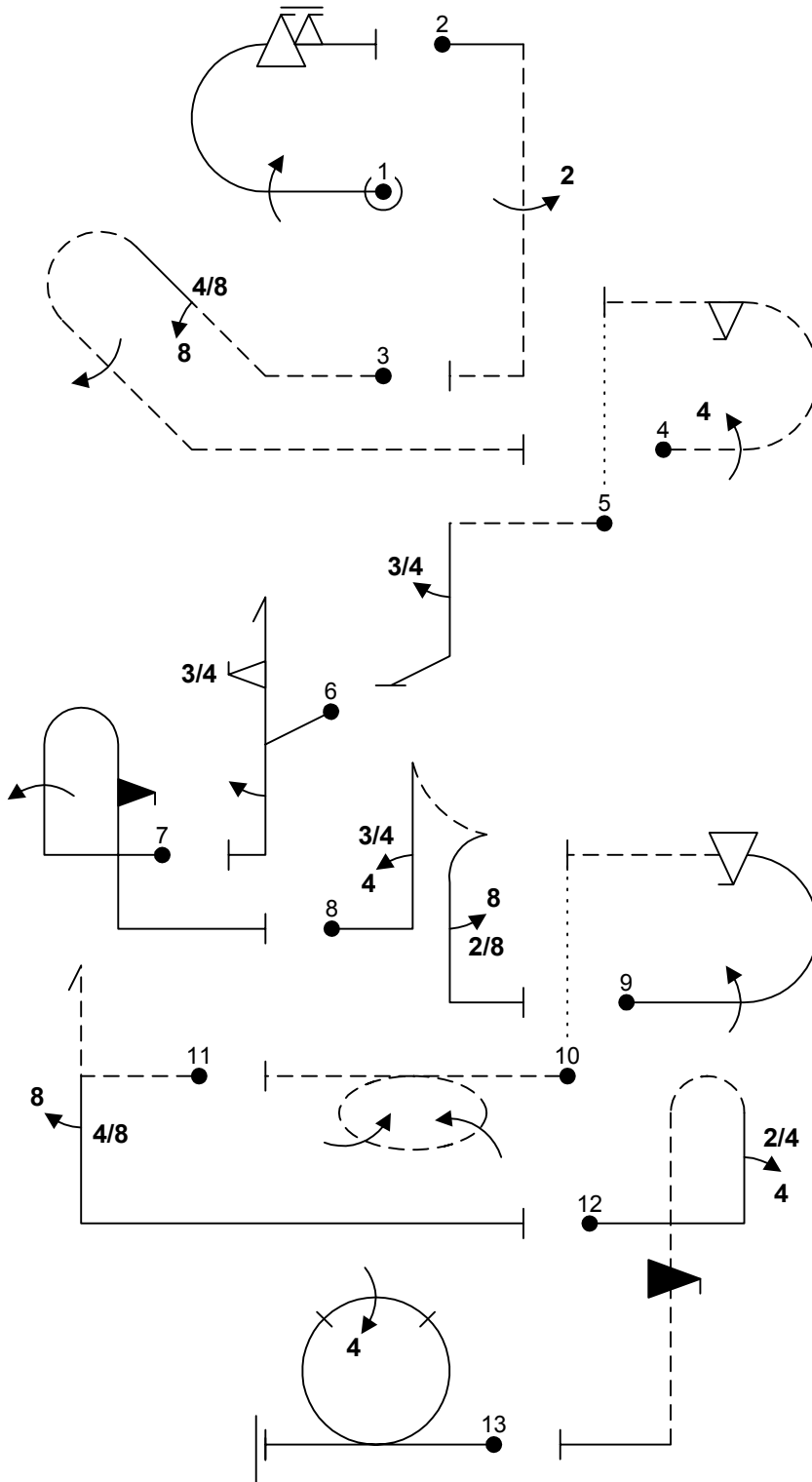

A/C:

(signature/date)

FREE PROGRAM CHECK BY: