

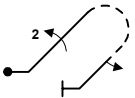







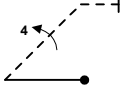
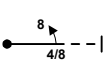

INTERNATIONAL AEROBATIC CLUB SCORESHEET					Contest:			Date:		Category		Programme		pilot's number	
								Unlimited		Unknown					
No	Symbol	Catalog No	K	Tot. K	Score	Remarks	No	Symbol	Catalog No	K	Tot. K	Score	Remarks		
1		8.18.1 9.2.2.4 9.1.4.2	14 11 4	29			13		6.1.1 9.1.1.3 9.10.5.3	15 10 13	38				
2		8.33.1 9.1.1.2 9.1.3.4	11 8 8	27			14		1.10.1 9.4.2.4	9 13	22				
3		1.1.3 9.8.3.2	2 7	9			15								
4		8.2.2 9.9.10.4	17 13	30			16								
5		8.1.1 9.1.1.4 9.10.10.3	13 12 15	40			17								
6		5.1.1 9.9.1.3 9.4.5.2	17 15 5	37			18								
7		7.1.1 9.1.3.4 9.9.3.4	6 8 11	25			POSITIONING					20			
8		2.9.2	23	23			FIGURE TOTAL K =					375			
9		8.41.2 9.2.4.4	12 9	21			INCLUDING POSITIONING =					395			
10		1.6.1 9.4.1.3	10 12	22			JUDGE'S NAME _____								
11		1.18.3 9.1.5.3 9.8.2.2	16 6 9	31			JUDGE'S NUMBER _____								
12		7.2.3 9.2.3.4 9.1.3.2	8 9 4	21			FREE PROGRAM CHECKED BY: _____								
							AIRCRAFT TYPE _____								

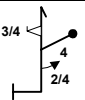

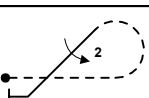
pilot's name
(print)



B	Contest:		Category:	Unlimited
Date:		Prog:	Unknown	pilot's number

wind direction

Pilot:

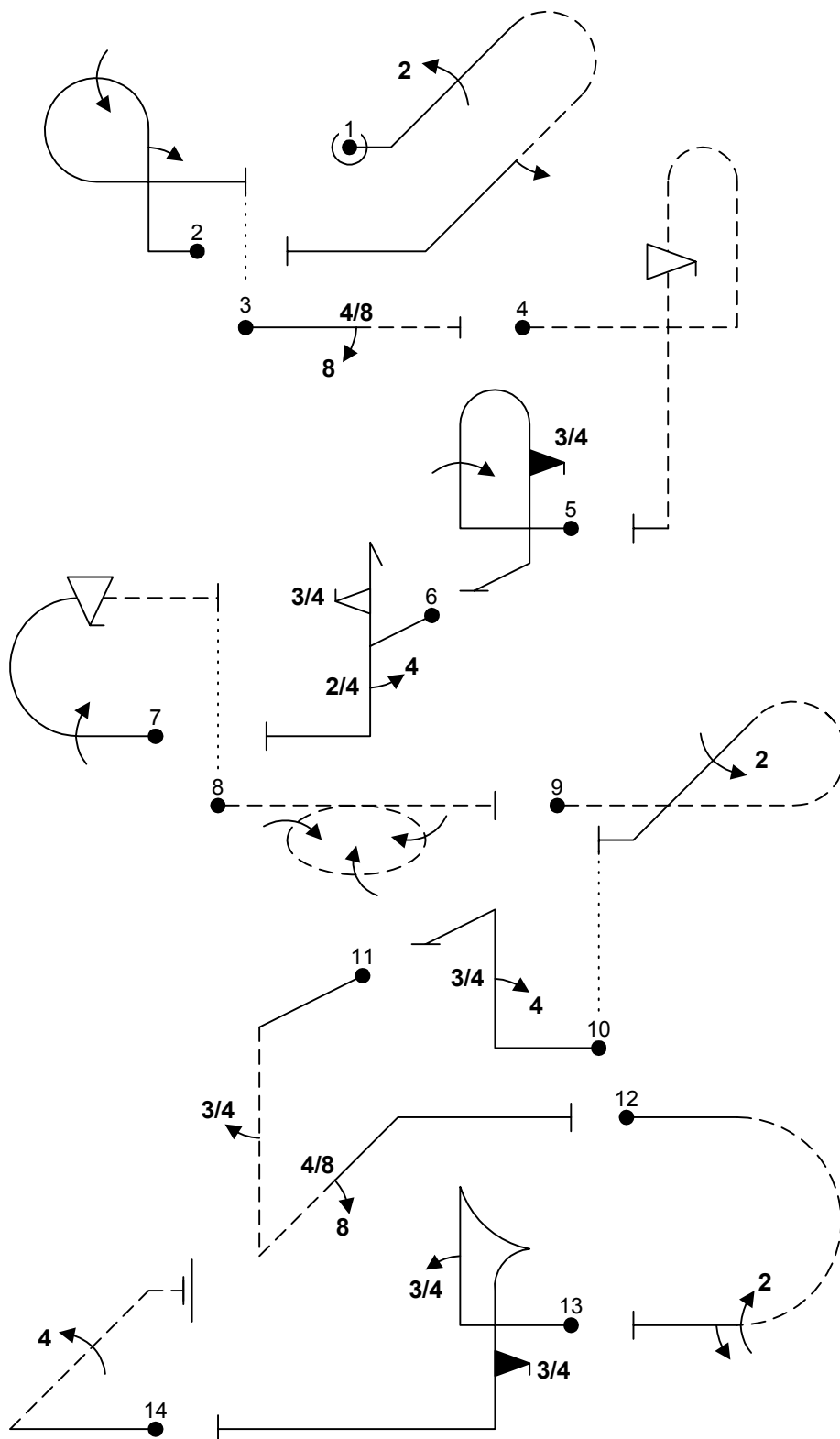

A/C:

(signature/date)

FREE PROGRAM CHECK BY:



C	Contest:		Category:	Unlimited	
Date:		Prog:	Unknown	pilot's number	

Pilot:

wind direction

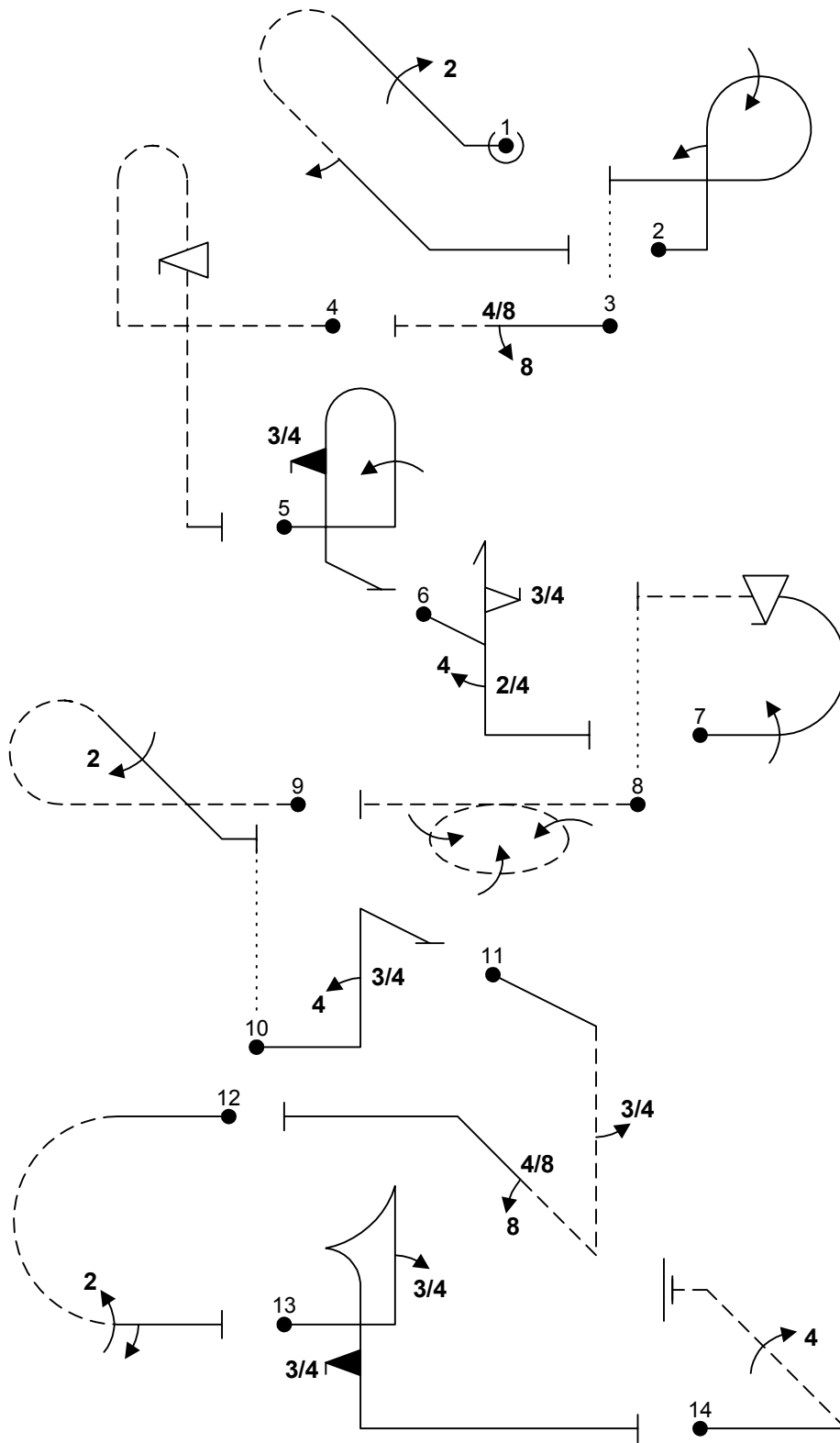

A/C:

(signature/date)

FREE PROGRAM CHECK BY: