

INTERNATIONAL AEROBATIC CLUB SCORESHEET

A

Contest: 2024 US Nationals	Date:	Category: Power Unlimited	Programme: Free Known	pilot's number	
--------------------------------------	-------	-------------------------------------	---------------------------------	----------------	--

No	Symbol	Cat. No.	K	Total K	Grade	Remarks	Item	K	Score
1		5.3.1.1 9.2.2.4 9.1.1.1 9.9.5.5	18 11 6 13	48			Presentation	40	
2		6.2.1.1 9.1.1.5 9.9.5.3	15 14 11	40					
3		1.3.4.1 9.4.2.2 9.10.2.4 9.1.2.6	18 7 15 12	52					
4		8.8.1.4 9.1.5.3 9.1.1.3 9.4.5.2	18 6 10 5	39					
5		1.3.11.1 9.2.1.4 9.10.4.5 9.1.4.3 9.1.1.4	20 13 15 6 12	66					
6		1.3.11.4 9.12.1.4 9.2.2.6	20 7 14	41					
7		8.8.2.1 9.4.1.3 9.8.1.1	19 12 7	38					
8		1.3.3.3 9.2.4.4 9.2.4.6	18 9 12	39					
9		7.5.2.1 9.4.3.4 9.1.4.6 9.2.3.6 9.9.3.6	15 11 10 12 14	62					
10		2.2.5.4	25	25					

FIGURE TOTAL K = 450

INC. PRESENTATION = 490

Aircraft type:
Pitts S-2S

FREE PROGRAM CHECKED BY:

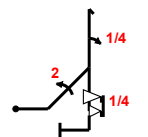
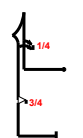
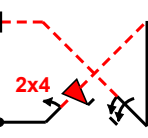
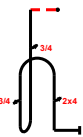
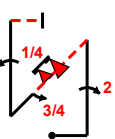
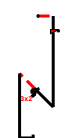
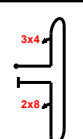
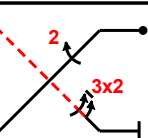
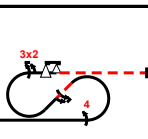
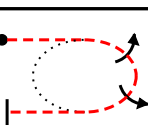
Signature:	Printed Name:	Date:
IAC No:		

Judge Name:

IAC #

Assistant Name:

IAC #

Yuichi Takagi Pilot
N8061J A/C

C	Contest:	2024 US Nationals	Category:	Power Unlimited
	Date:		Program:	Free Known
			Pilot's No.	<input style="border: 2px solid black; width: 50px; height: 20px;" type="text"/>

Pilot: Yuichi Takagi

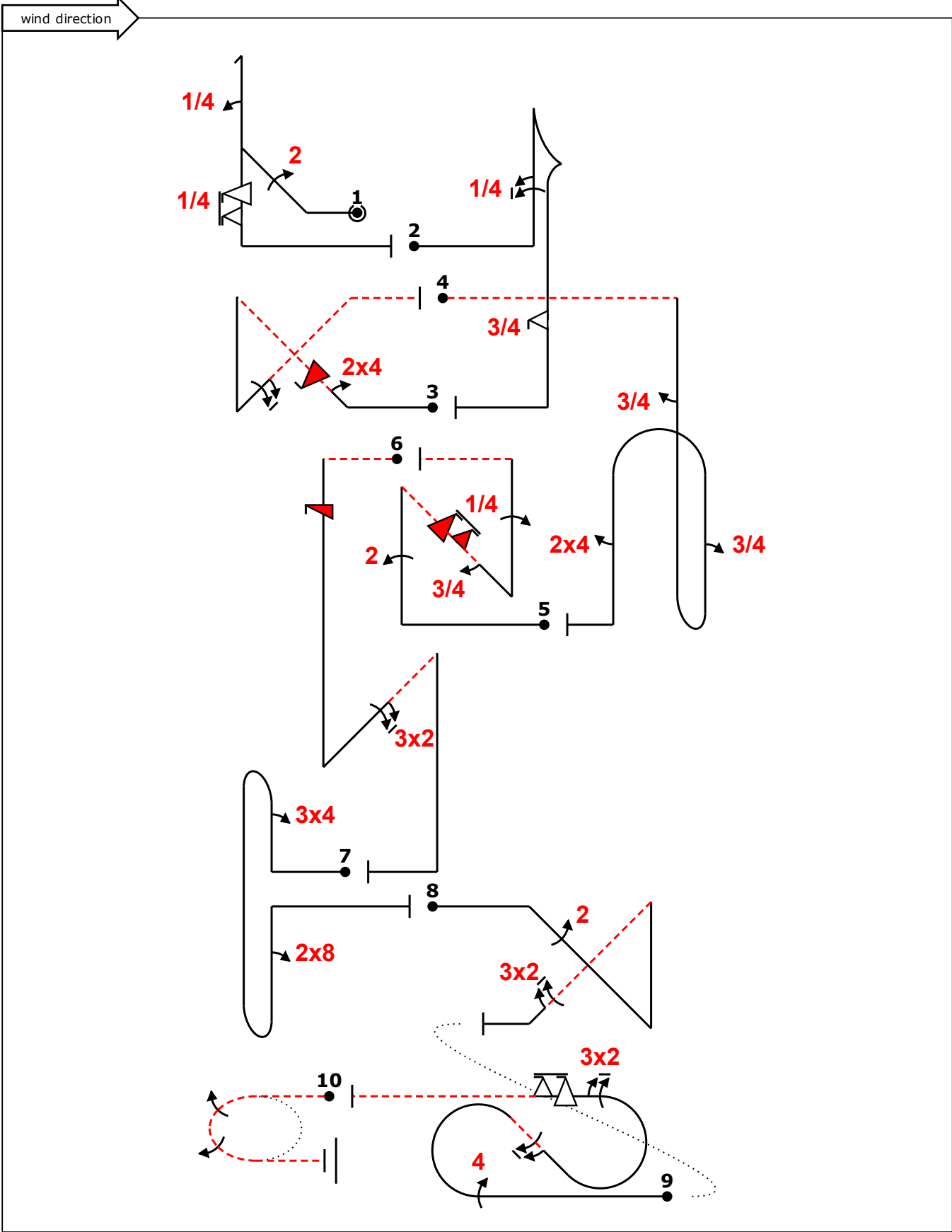

A/C: Pitts S-2S

(signature/date)

FREE PROGRAM CHECK BY: