

INTERNATIONAL AEROBATIC CLUB SCORESHEET - GLIDERS

A	Contest:	Date:	Category: Unlimited Glider	Program: Unknown	pilot's number	

No	Symbol	Catalogue No.	K	Total K	Grade	Remarks	Item	K	Score
1		8.6.4.1 9.4.3.2	14 8	22			Presentation	25	
2		7.3.4.1 9.9.2.2 9.1.2.2	16 15 9	40					
3		1.1.7.4 9.12.1.5	9 8	17					
4		8.4.3.1 9.1.5.1	15 3	18					
5		7.2.1.1 9.2.3.4	6 14	20					
6		2.2.3.4	35	35					
7		7.3.3.3 9.1.4.2	14 6	20					
8		6.2.1.3	18	18					

FIGURE TOTAL K = 190

INCLUDING PRESENTATION = 215

Aircraft Type:

FREE PROGRAM CHECKED BY:

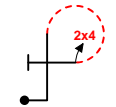
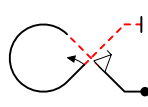
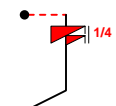
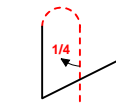
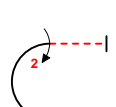
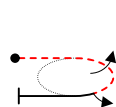
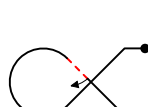
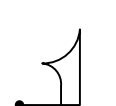
Signature:	Printed Name:	Date:

Judge Name:

IAC#

Assistant Name:

IAC#



Pilot IAC



B	Contest:	Category: Unlimited Glider	
	Date:	Program: Unknown	Pilot's No. <input type="text"/>

wind direction

pilot
NAC

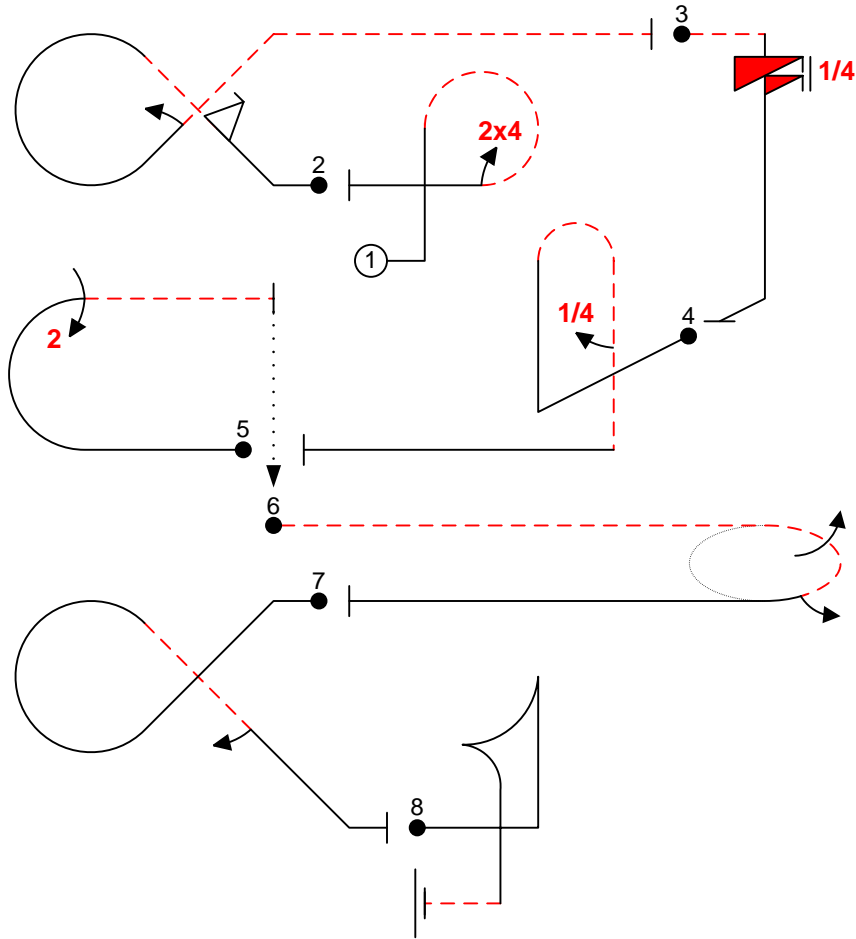

A/C:

GLIDER FREE PROGRAM CHECK BY: (signature/date)



C	Contest:	Category: Unlimited Glider	
	Date:	Program: Unknown	Pilot's No. <input type="text"/>

pilot

NAC

wind direction

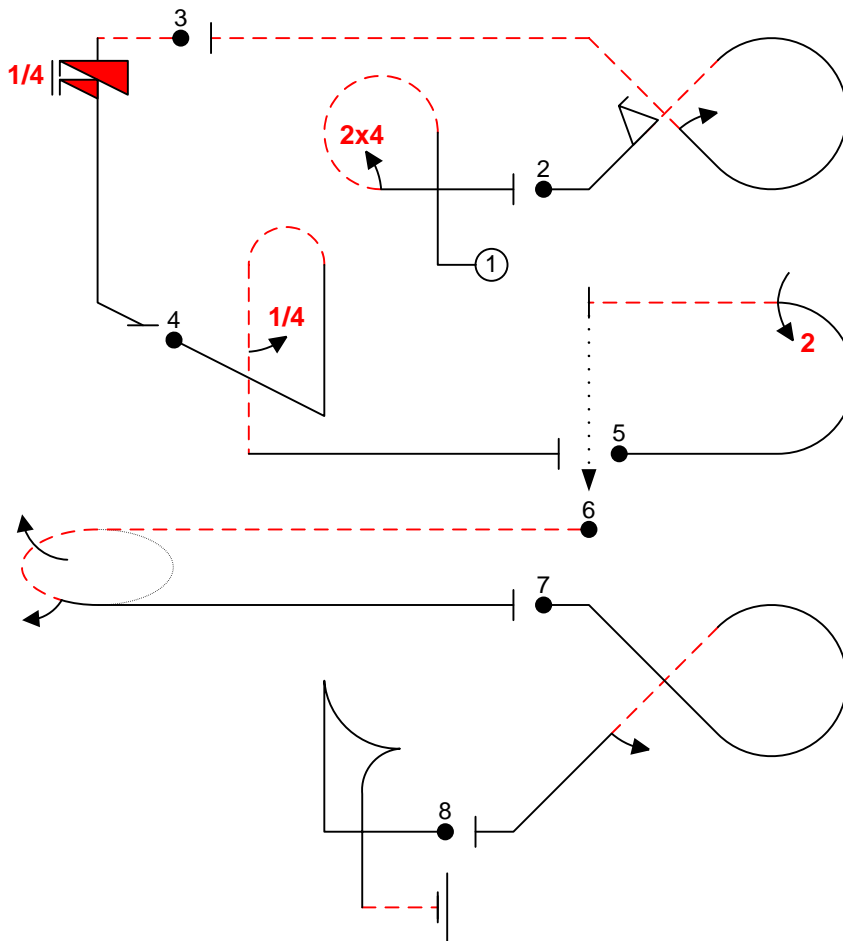

A/C:

(signature/date)

GLIDER FREE PROGRAM CHECK BY: