

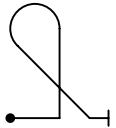



INTERNATIONAL AEROBATIC CLUB SCORESHEET

A	Contest:	Date:	Category: Intermediate	Programme: Unknown	pilot's number	

No	Symbol	Catalogue No.	K	Total K	Grade	Remarks	Item	K	Score						
1		8.5.17.1	12	12			Presentation	8							
2		7.8.3.1 9.4.4.2	19 5	24						FIGURE TOTAL K =	175				
3		7.2.3.2 9.1.3.2	7 4	11						INCLUDING PRESENTATION =	183				
4		1.3.4.4 9.4.4.2 9.4.4.2	18 5 5	28						Aircraft Type:					
5		5.2.1.1 9.1.5.1	17 2	19						FREE PROGRAM CHECKED BY: Signature: _____ Printed Name: _____ IAC No. _____ Date: _____					
6		5.2.1.1 9.1.1.1 9.1.5.2	17 6 4	27									Judge Name: _____		
7		8.6.1.1 9.1.3.4	11 8	19									IAC# _____		
8		7.2.2.1 9.1.3.2	6 4	10									Assistant Name: _____		
9		1.1.1.1 9.2.3.4	2 9	11									IAC# _____		
10		2.1.3.1	14	14											

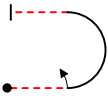
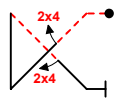
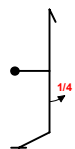
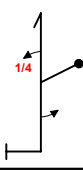
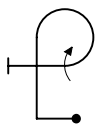
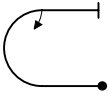
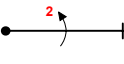

Pilot _____
IAC _____



B	Contest:	Category: Intermediate	
	Date:	Program: Unknown	Pilot's No. <input type="text"/>

wind direction

Pilot
NAC

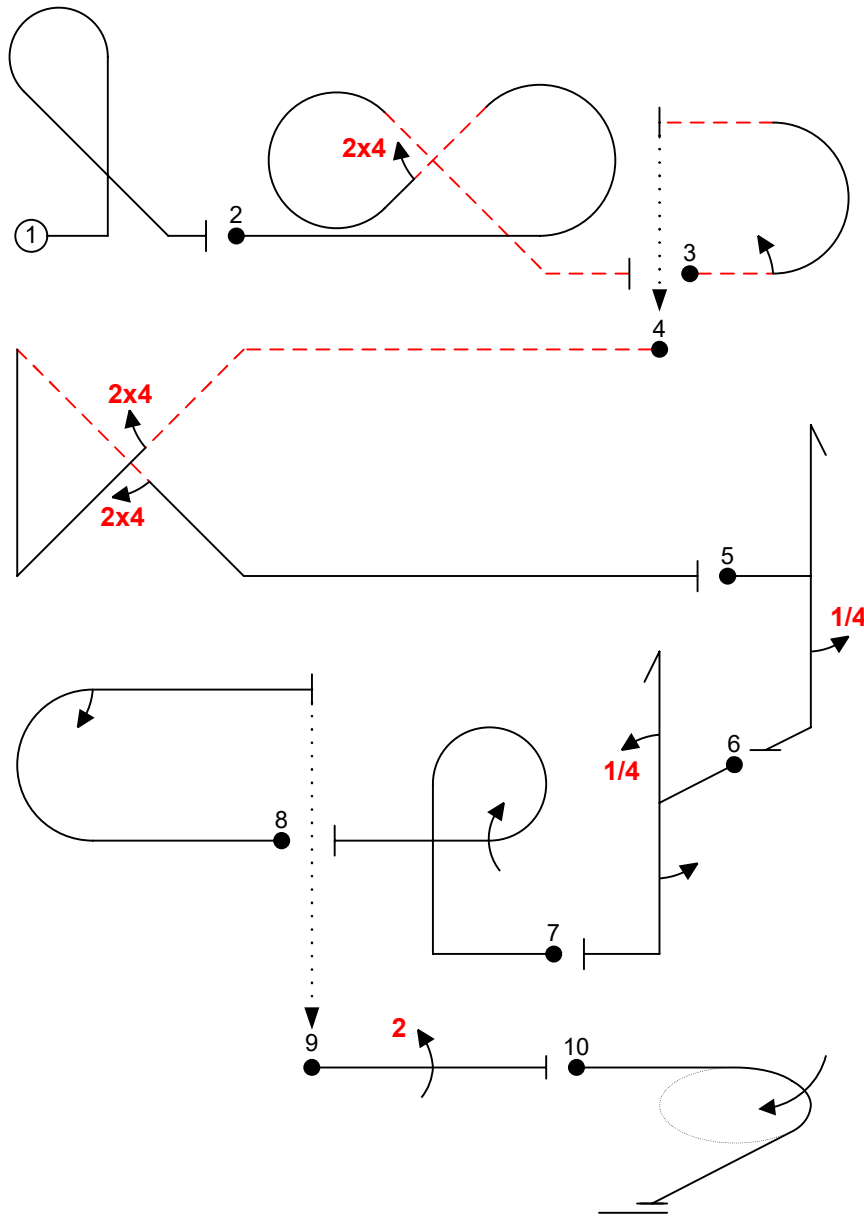

A/C:

(signature/date)

FREE PROGRAM CHECK BY:



C	Contest:	Category: Intermediate	
	Date:	Program: Unknown	Pilot's No. <input type="text"/>

pilot

NAC

wind direction

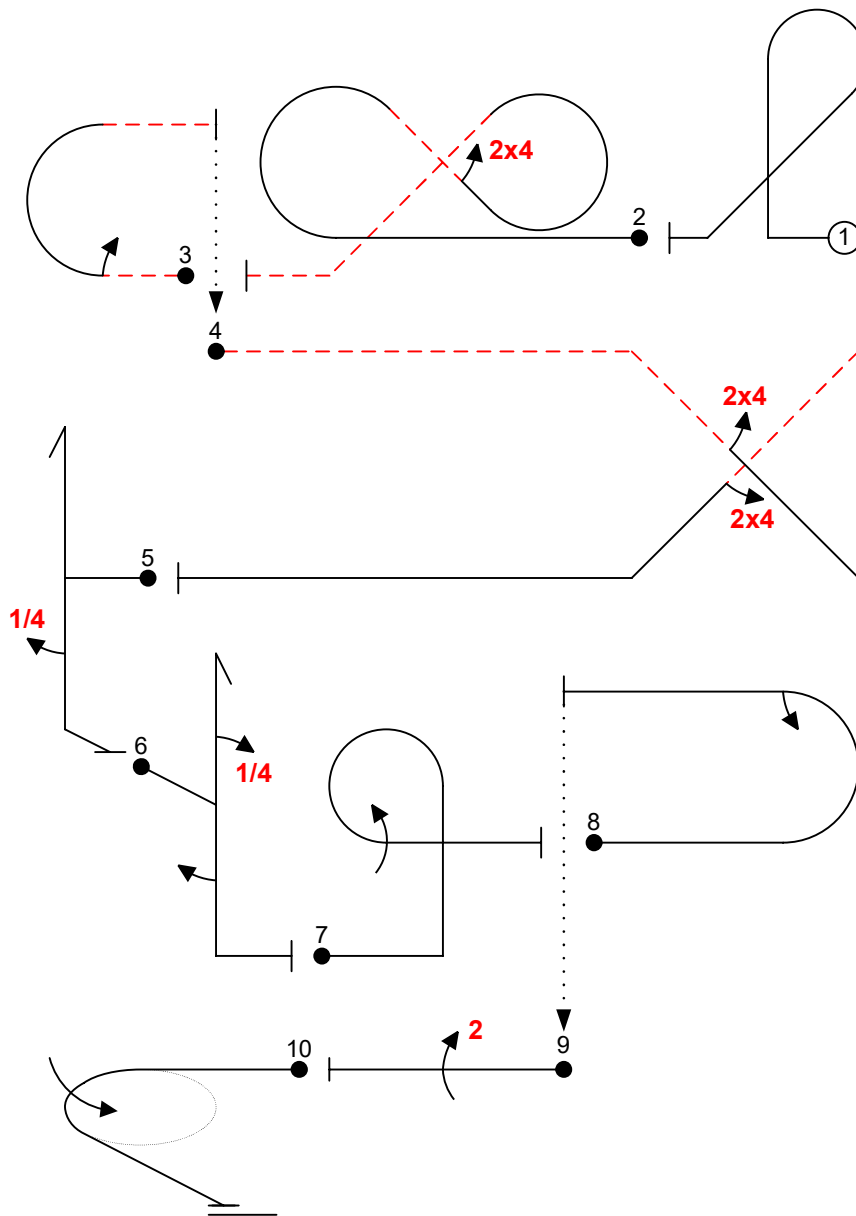

A/C:

(signature/date)

FREE PROGRAM CHECK BY: