

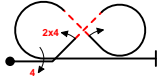

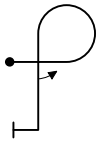
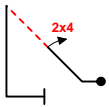
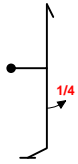

INTERNATIONAL AEROBATIC CLUB SCORESHEET

**A**

Contest:	Date:	Category: <b>Intermediate</b>	Programme: <b>Unknown</b>	pilot's number	
----------	-------	----------------------------------	------------------------------	----------------	--

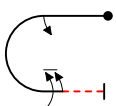
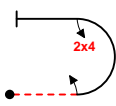
No	Symbol	Catalogue No.	K	Total K	Grade	Remarks
1		7.8.8.1 9.4.2.2 9.1.2.2 9.4.3.4	19 7 6 11	43		
2		8.6.5.1 9.1.5.2	11 4	15		
3		1.2.3.1 9.4.2.2	12 7	19		
4		5.2.1.1 9.1.5.1	17 2	19		
5		1.1.6.1 9.1.1.1	10 6	16		
6		1.1.1.1 9.1.3.4	2 8	10		
7		7.2.4.3 9.1.3.2 9.1.3.6	6 4 10	20		
8		7.2.4.2 9.1.3.2 9.4.3.2	6 4 5	15		
9		1.2.2.3 9.1.1.1	12 6	18		

**Presentation** **8**

FIGURE TOTAL K = **175**

INCLUDING PRESENTATION = **183**

Aircraft Type:

FREE PROGRAM CHECKED BY:

Signature:	Printed Name:	Date:
		IAC No.

Judge Name:

IAC#

Assistant Name:

IAC#







<b>C</b>	Contest:	Category: <b>Intermediate</b>	
	Date:	Program: <b>Unknown</b>	Pilot's No. <input type="text"/>

pilot

NAC

wind direction

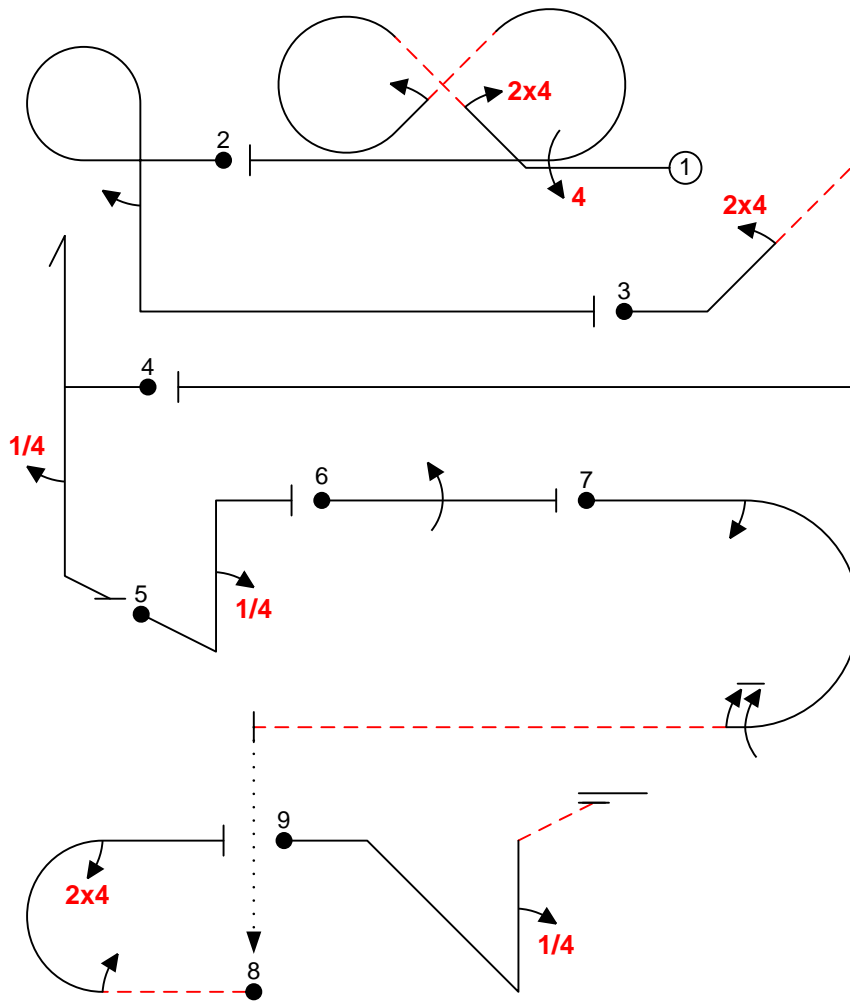

A/C:

(signature/date)

FREE PROGRAM CHECK BY: