

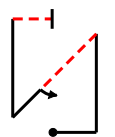

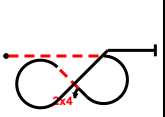



INTERNATIONAL AEROBATIC CLUB SCORESHEET

A

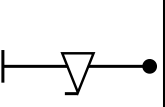
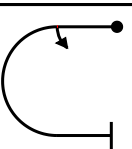
Contest:	Date:	Category: Power Intermediate	Programme: Unknown	pilot's number	
----------	-------	------------------------------------	-----------------------	-------------------	--

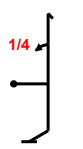
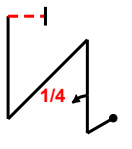
No	Symbol	Cat. No.	K	Total K	Grade	Remarks	Item	K	Score							
1		1.3.11.1 9.1.4.2	20 4	24			Presentation	20								
2		7.8.3.4 9.4.2.2	19 7	26			FIGURE TOTAL K =	171								
3		8.6.4.3 9.11.1.4 9.1.3.2	13 5 4	22			INC. PRESENTATION =	191								
4		1.1.1.1 9.9.3.4	2 11	13			Aircraft type:									
5		7.2.3.3 9.1.3.2	6 4	10			<div style="display: flex; justify-content: space-between;"> <div style="writing-mode: vertical-rl; transform: rotate(180deg);">FREE PROGRAM CHECKED BY:</div> <div style="width: 80%;"> <table border="1" style="width: 100%; border-collapse: collapse;"> <tr> <td style="width: 30%; height: 100px; vertical-align: bottom;">Signature:</td> <td style="width: 30%; height: 100px; vertical-align: bottom;">Printed Name:</td> <td style="width: 40%; height: 100px; vertical-align: bottom;">Date:</td> </tr> </table> </div> </div> <div style="margin-top: 10px;"> <table border="1" style="width: 100%; border-collapse: collapse;"> <tr> <td style="width: 100%;">Judge Name:</td> </tr> <tr> <td style="width: 100%;">IAC #</td> </tr> <tr> <td style="width: 100%;">Assistant Name:</td> </tr> <tr> <td style="width: 100%;">IAC #</td> </tr> </table> </div> <div style="margin-top: 20px; text-align: center;">  </div> <div style="margin-top: 20px; text-align: right;"> <p style="font-size: 1.2em; margin: 0;">Pilot</p> <p style="font-size: 1.2em; margin: 0;">A/C</p> </div>			Signature:	Printed Name:	Date:	Judge Name:	IAC #	Assistant Name:	IAC #
Signature:	Printed Name:	Date:														
Judge Name:																
IAC #																
Assistant Name:																
IAC #																
6		5.2.1.1 9.1.1.1	17 6	23												
7		1.3.14.1 9.1.1.1	22 6	28												
8		1.1.1.4 9.4.3.2	2 5	7												
9		2.2.1.1	4	4												
10		2.1.3.1	14	14												

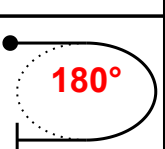
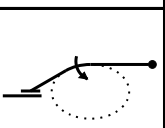

Pilot

A/C



B	Contest:	Category: Power Intermediate
	Date:	Program: Unknown
		Pilot's No.

Pilot:

wind direction

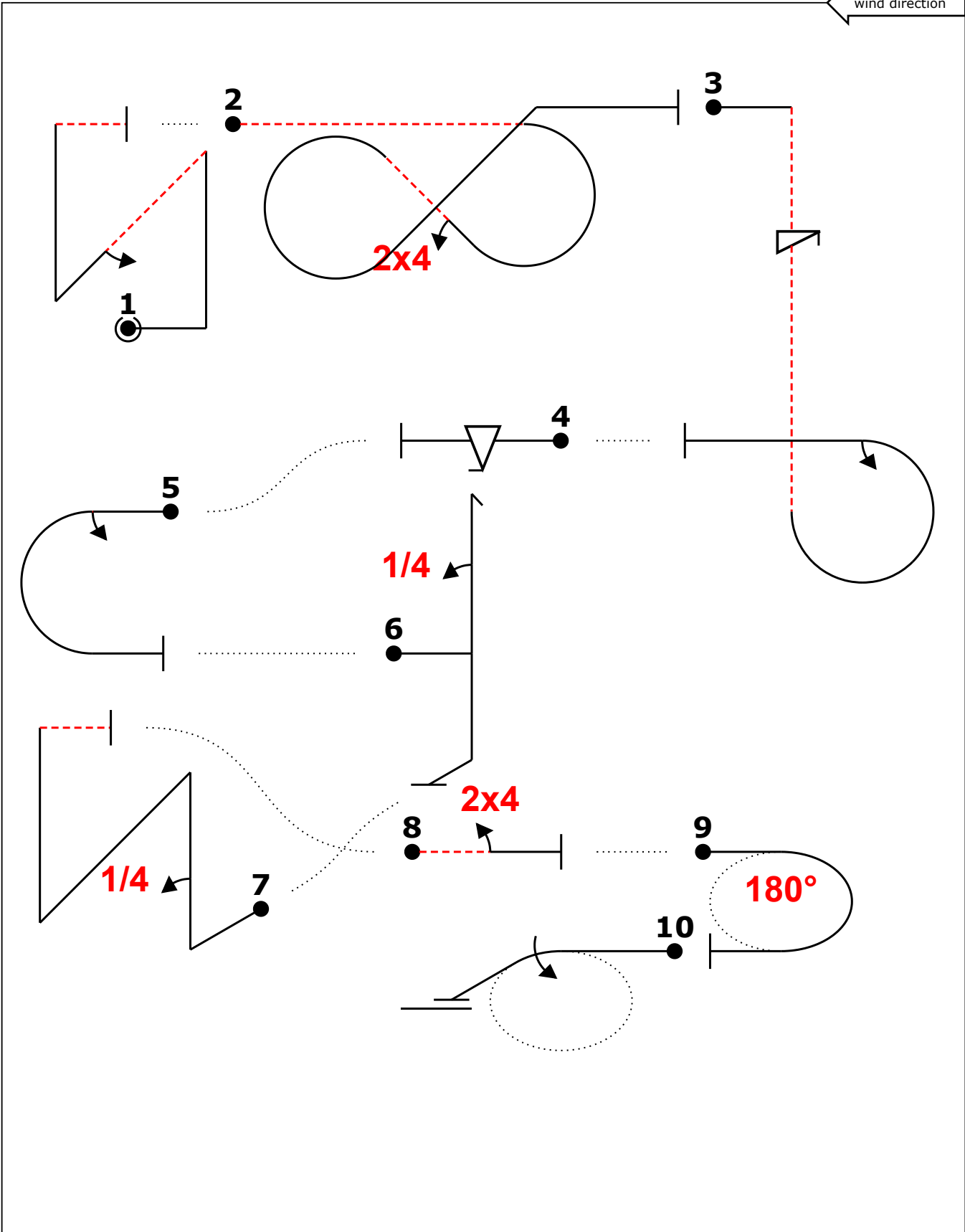

A/C:

(signature/date)

FREE PROGRAM CHECK BY:



C	Contest:	Category: Power Intermediate
	Date:	Program: Unknown
		Pilot's No. <input type="text"/>

Pilot:

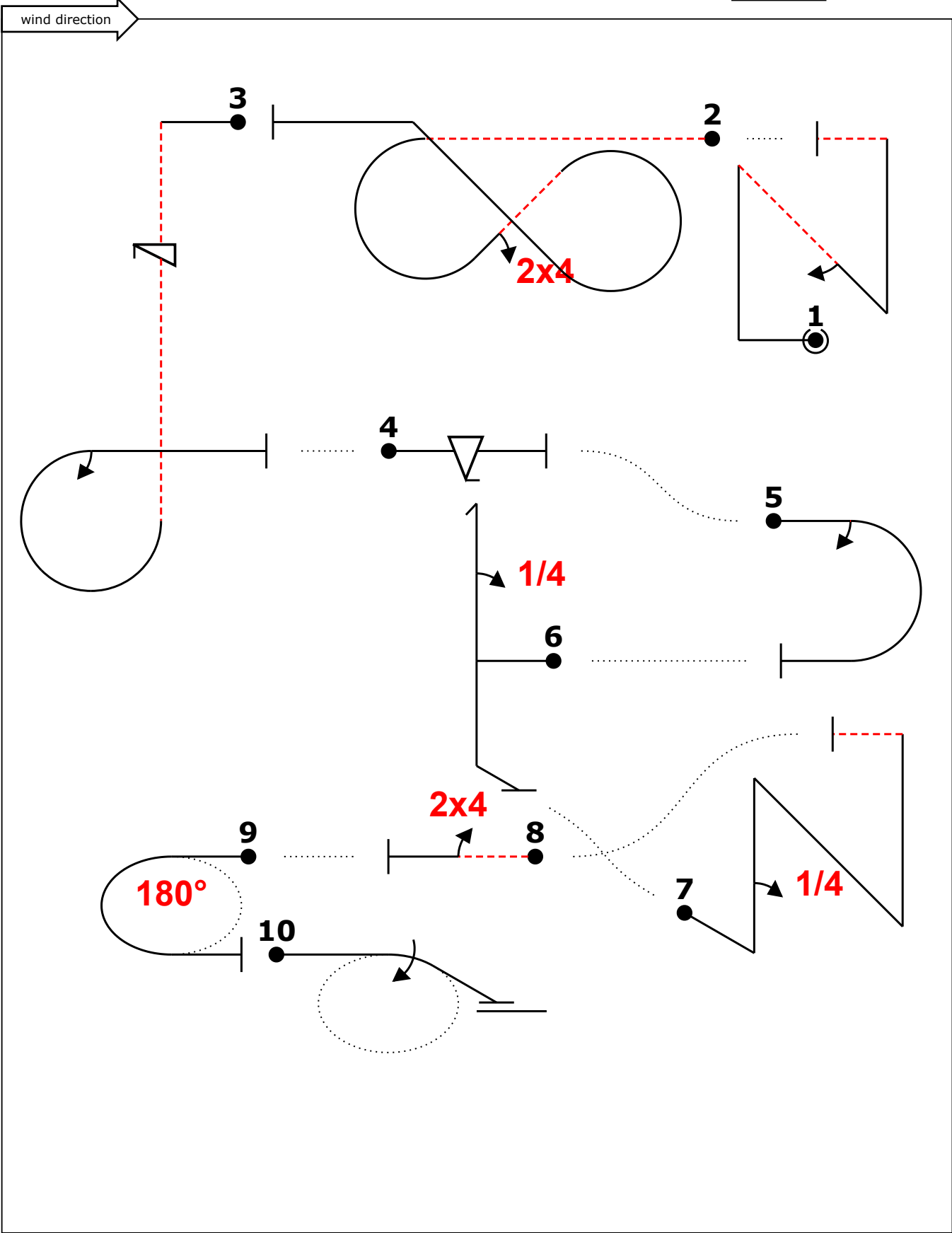

A/C:

(signature/date)

FREE PROGRAM CHECK BY:



Category: Power Intermediate

Date:

Program: Unknown

wind direction

R

Figure K
171
Total K
191

Judge Name IAC#
Asst. Name IAC#

Pilot #

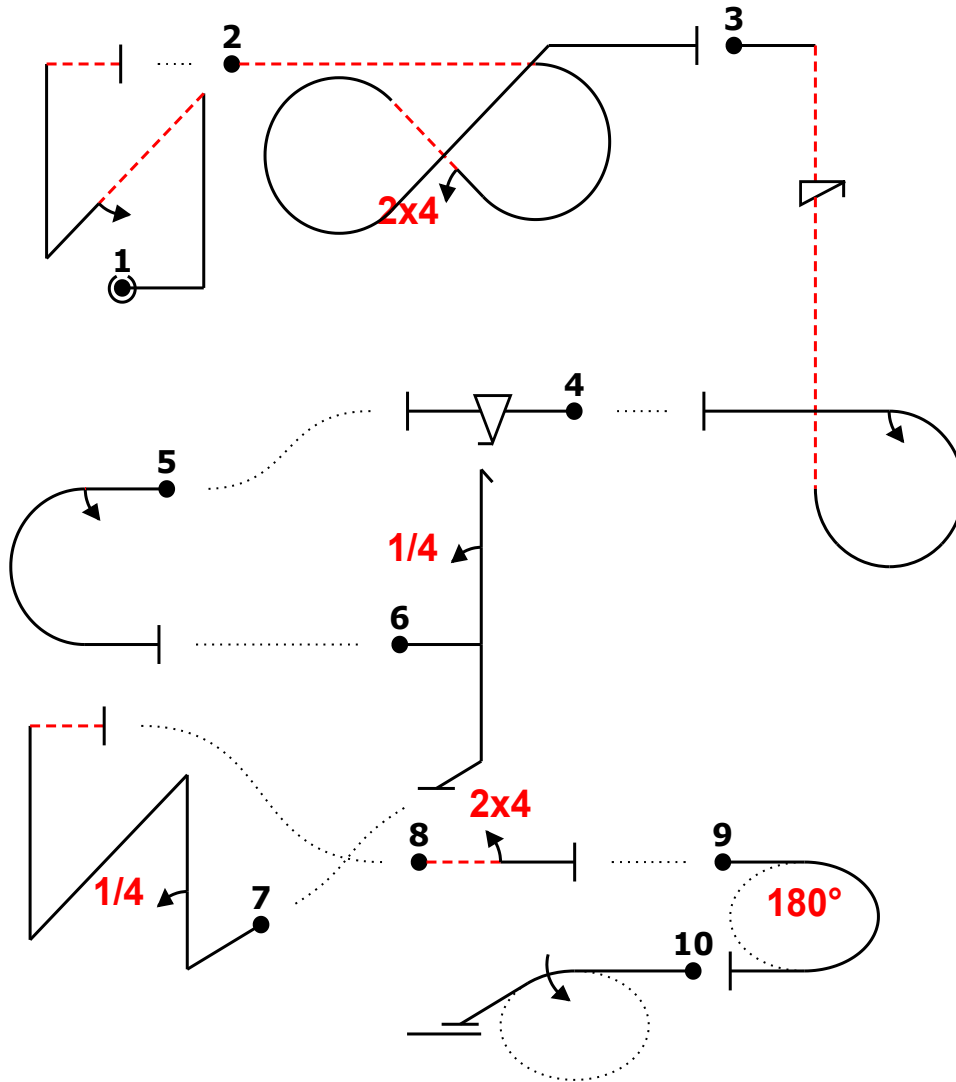

Fig	Grade	Remarks
1	.	
2	.	
3	.	
4	.	
5	.	
6	.	
7	.	
8	.	
9	.	
10	.	

n(2)- (2,0) -icc(24') .s..'irp2+~ (-3,0) f (-9,4) 2a (9,0) '4h (-6,5) ~4pn'- (13,7) -24 (4,0) 2j 1j1

Presentation
20

Fig 1	K	Fig 2	K	Fig 3	K	Fig 4	K	Fig 5	K	Fig 6	K	Fig 7	K	Fig 8	K	Fig 9	K	Fig 10	K
1.3.11.1	20	7.8.3.4	19	8.6.4.3	13	1.1.1.1	2	7.2.3.3	6	5.2.1.1	17	1.3.14.1	22	1.1.1.4	2	2.2.1.1	4	2.1.3.1	14
9.1.4.2	4	9.4.2.2	7	9.11.1.4	5	9.9.3.4	11	9.1.3.2	4	9.1.1.1	6	9.1.1.1	6	9.4.3.2	5				
	24		26	9.1.3.2	4		13		10		23		28		7		4		14

Pilot:

A/C:



Category: Power Intermediate Date: _____
 Program: Unknown

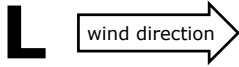

Figure K
171
 Total K
191

Judge Name	IAC#	Pilot #
Asst. Name	IAC#	

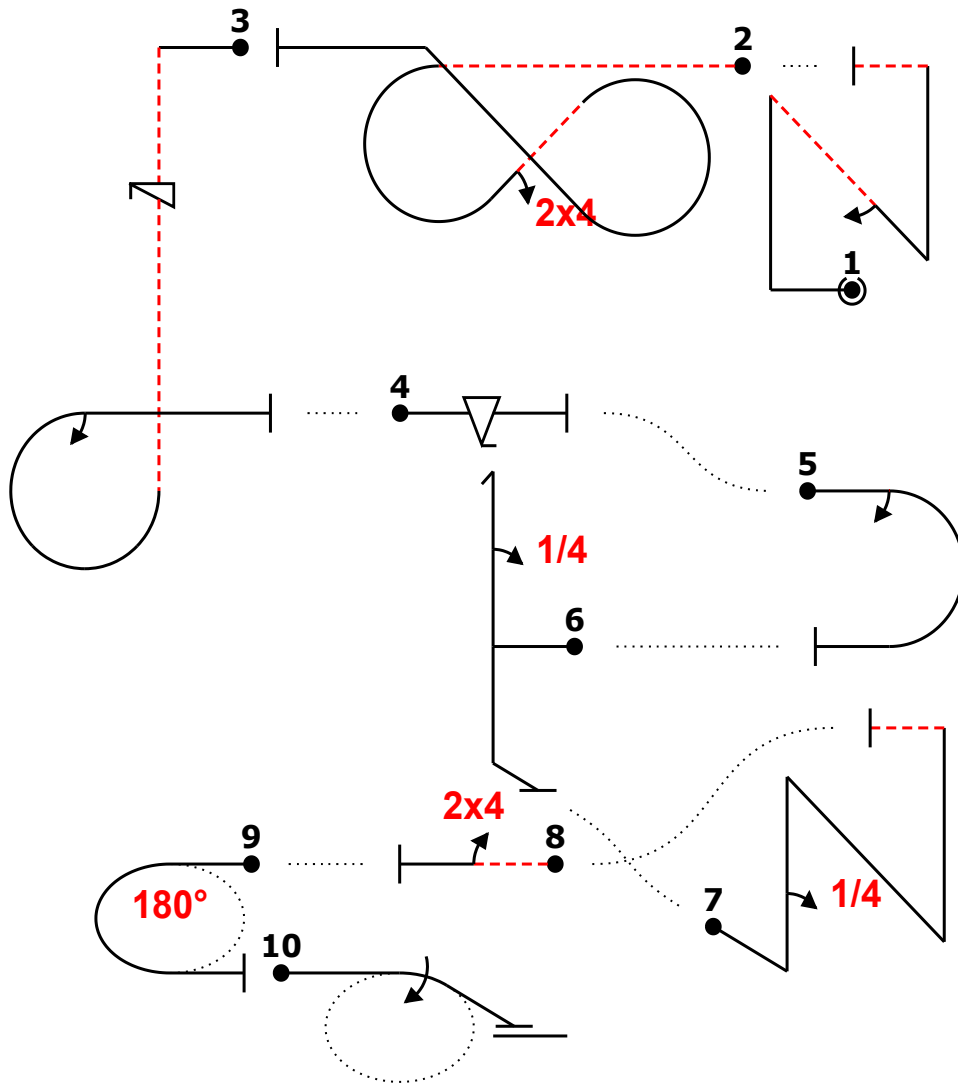

Fig	Grade	Remarks
1	.	
2	.	
3	.	
4	.	
5	.	
6	.	
7	.	
8	.	
9	.	
10	.	

n(2)- (2,0) -icc(24') .s..'irp2+~ (-3,0) f (-9,4) 2a (9,0) '4h (-6,5) ~4pn'- (13,7) -24 (4,0) 2j 1j1

Presentation
20 .

Fig 1	K	Fig 2	K	Fig 3	K	Fig 4	K	Fig 5	K	Fig 6	K	Fig 7	K	Fig 8	K	Fig 9	K	Fig 10	K
1.3.11.1	20	7.8.3.4	19	8.6.4.3	13	1.1.1.1	2	7.2.3.3	6	5.2.1.1	17	1.3.14.1	22	1.1.1.4	2	2.2.1.1	4	2.1.3.1	14
9.1.4.2	4	9.4.2.2	7	9.11.1.4	5	9.9.3.4	11	9.1.3.2	4	9.1.1.1	6	9.1.1.1	6	9.4.3.2	5				
	24		26	9.1.3.2	4		13		10		23		28		7		4		14

Pilot: _____

A/C: _____