

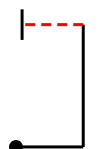

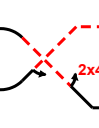

INTERNATIONAL AEROBATIC CLUB SCORESHEET

A

Contest:	Date:	Category: Power Intermediate	Programme: Unknown	pilot's number	
----------	-------	------------------------------------	-----------------------	-------------------	--

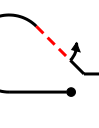
No	Symbol	Cat. No.	K	Total K	Grade	Remarks	Item	K	Score
1		1.1.7.1	9	9			Presentation	20	
2		7.3.4.4 9.1.4.2 9.4.4.2	15 4 5	24					FIGURE TOTAL K = 172
3		5.2.1.1 9.1.5.1	17 2	19					INC. PRESENTATION = 192
4		5.2.1.1 9.1.1.1	17 6	23					Aircraft type:
5		8.5.6.1 9.1.4.2	10 4	14					
6		8.7.5.1 9.9.3.4	11 11	22					
7		8.4.1.1 9.1.1.1 9.1.5.1	13 6 2	21					
8		8.5.2.1 9.1.2.2	10 6	16					
9		7.8.3.1 9.4.4.2	19 5	24					

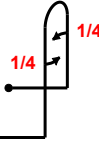
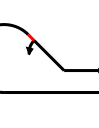
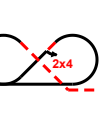
FREE PROGRAM CHECKED BY:

Signature:	Printed Name:	Date:
IAC No:		

Judge Name:
IAC #

Assistant Name:
IAC #



_____ Pilot
 A/C



Category: Power Intermediate

Date:

Program: Unknown

Figure K

172

Total K

192

Judge Name IAC#

Pilot #

Asst. Name IAC#

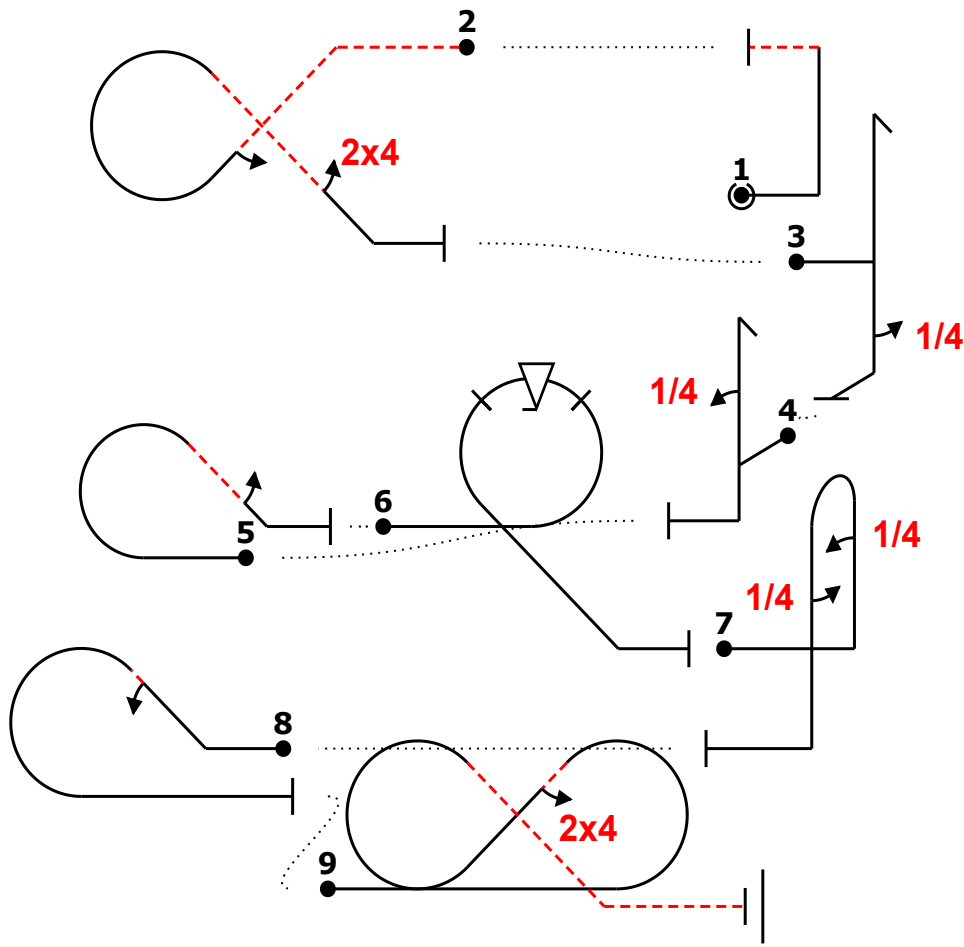
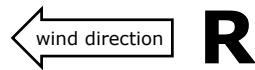

Fig	Grade	Remarks
1	.	
2	.	
3	.	
4	.	
5	.	
6	.	
7	.	
8	.	
9	.	

Presentation 20 .

v- (-12,0) --2ig'24'' (16,1) h4 (1,0) 4h'' (-20,2) -1%c''2'''''''' (-1,0) q(f)' ~''|4b''''|4.' (-20, 0)2''rc+'' (-2,5) cc(24)''-

Fig 1	K	Fig 2	K	Fig 3	K	Fig 4	K	Fig 5	K	Fig 6	K	Fig 7	K	Fig 8	K	Fig 9	K
1.1.7.1	9	7.3.4.4	15	5.2.1.1	17	5.2.1.1	17	8.5.6.1	10	8.7.5.1	11	8.4.1.1	13	8.5.2.1	10	7.8.3.1	19
		9.1.4.2	4	9.1.5.1	2	9.1.1.1	6	9.1.4.2	4	9.9.3.4	11	9.1.1.1	6	9.1.2.2	6	9.4.4.2	5
		9.4.4.2	5									9.1.5.1	2				
	9		24		19		23		14		22		21		16		24

Pilot:

A/C:



Category: Power Intermediate Date: _____
 Program: Unknown

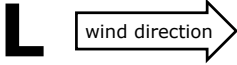

Figure K 172	Judge Name	IAC#	Pilot #
Total K 192	Asst. Name	IAC#	

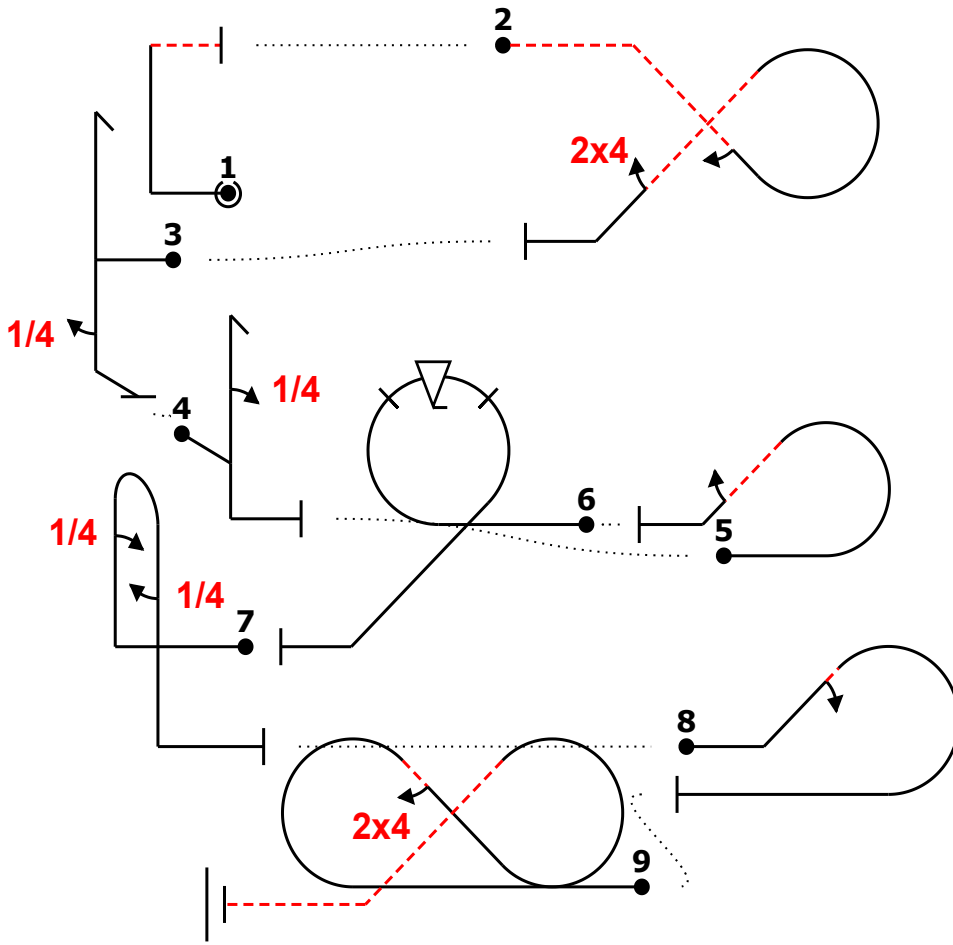

Fig	Grade	Remarks
1	.	
2	.	
3	.	
4	.	
5	.	
6	.	
7	.	
8	.	
9	.	

Presentation **20** .

v- (-12,0) --2ig'24'' (16,1) h4 (1,0) 4h''' (-20,2) -1%c''2'''''''''' (-1,0) q(f)' ~''4b''''4.' (-20,0)2''rc+'' (-2,5) cc(24)''-

Fig 1	K	Fig 2	K	Fig 3	K	Fig 4	K	Fig 5	K	Fig 6	K	Fig 7	K	Fig 8	K	Fig 9	K
1.1.7.1	9	7.3.4.4	15	5.2.1.1	17	5.2.1.1	17	8.5.6.1	10	8.7.5.1	11	8.4.1.1	13	8.5.2.1	10	7.8.3.1	19
		9.1.4.2	4	9.1.5.1	2	9.1.1.1	6	9.1.4.2	4	9.9.3.4	11	9.1.1.1	6	9.1.2.2	6	9.4.4.2	5
		9.4.4.2	5									9.1.5.1	2				
	9		24		19		23		14		22		21		16		24

Pilot: _____

A/C: _____