

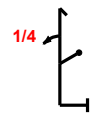

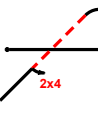





INTERNATIONAL AEROBATIC CLUB SCORESHEET										
A	Contest:			Date:	Category: Power Intermediate	Programme: Unknown	pilot's number			
	No	Symbol	Cat. No.	K	Total K	Grade	Remarks	Item	K	Score
1		5.2.1.1 9.1.1.1	17 6	23	SF 5			Presentation	20	
2		8.5.6.1 9.4.4.2	10 5	15	SF 7			FIGURE TOTAL K =	167	
3		1.2.7.1 9.1.4.2	13 4	17	SF 7			INC. PRESENTATION =	187	
4		1.1.6.1 9.1.1.1	10 6	16	SF 7			Aircraft type:		
5		1.1.6.3 9.11.1.5	10 4	14	SF 3			FREE PROGRAM CHECKED BY: Signature: _____ Printed Name: _____ IAC No: _____ Date: _____		
6		7.4.3.1	14	14	SF 7					
7		8.4.1.1 9.1.1.1 9.1.5.1	13 6 2	21	SF 7			Judge Name: _____		
8		7.4.1.1 9.2.3.4	10 9	19	SF 7			IAC # _____		
9		7.2.2.1 9.1.3.2	6 4	10	SF 7			Assistant Name: _____		
10		2.3.1.1	5	5	SF 2			IAC # _____		
11		1.1.1.1 9.9.3.4	2 11	13	SF 4			 _____ Pilot _____ _____ A/C _____		

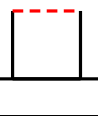
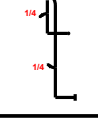
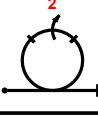
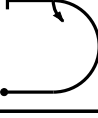

B	Contest:	Category:
	Date:	Program: Unknown

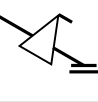
Pilot:

Note Y Axis Entry

wind direction

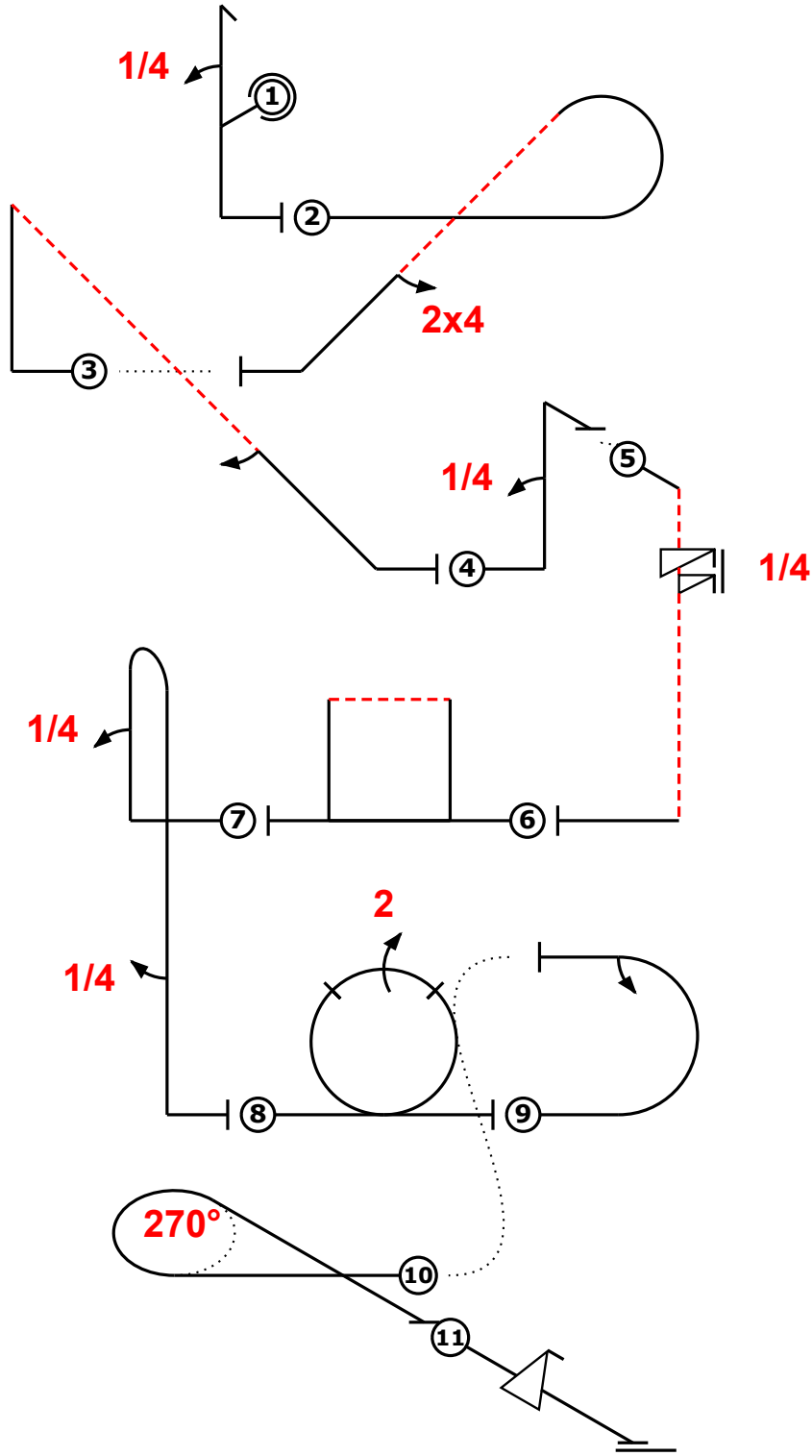

A/C:

(signature/date)

FREE PROGRAM CHECK BY:



C	Contest:	Category: Power Intermediate
	Date:	Program: Unknown
		Pilot's No. <input type="text"/>

Pilot:

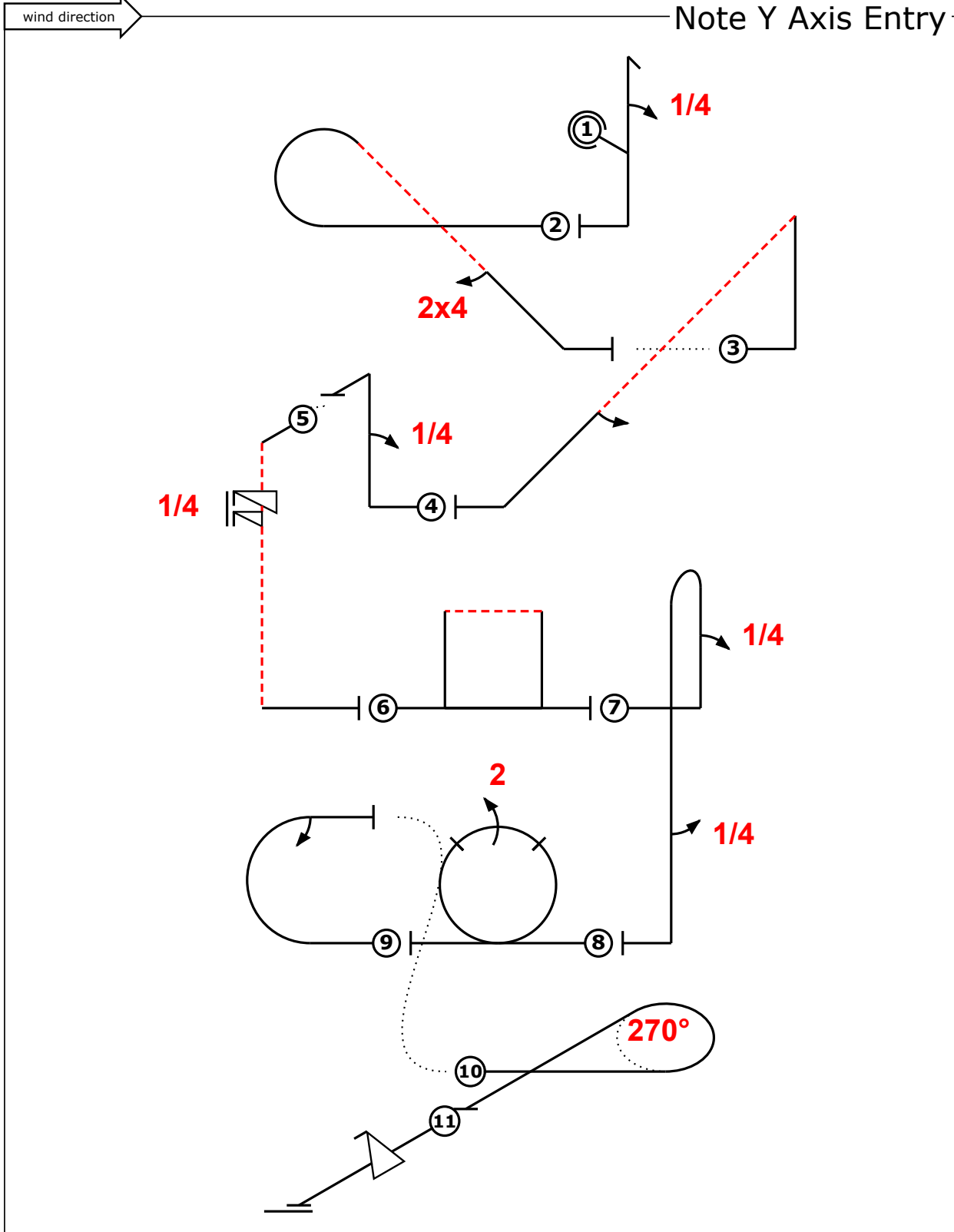

A/C:

(signature/date)

FREE PROGRAM CHECK BY:

wind direction

