

INTERNATIONAL AEROBATIC CLUB SCORESHEET

A	Contest:	Date:	Category: Intermediate	Programme: Unknown	pilot's number	



No	Symbol	Catalogue No.	K	Total K	Grade	Remarks	Item	K	Score
1		7.3.4.1 9.4.2.2 9.1.2.2	16 7 6	29			Presentation	8	
2		1.2.5.4 9.1.2.4	14 10	24					
3		8.6.3.3 9.11.1.4	13 5	18					
4		1.1.7.4 9.1.5.1	9 2	11					
5		8.4.3.1 9.1.1.1 9.1.5.2	15 6 4	25					
6		7.2.2.1 9.1.3.2	6 4	10					
7		1.3.3.3 9.1.4.4 9.4.4.2	18 8 5	31					
8		5.2.1.1	17	17					
9		7.4.1.1	10	10					

FIGURE TOTAL K = **175**

INCLUDING PRESENTATION = **183**

Aircraft Type:

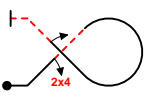
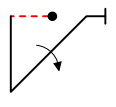
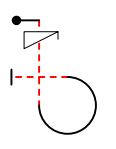
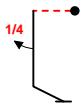
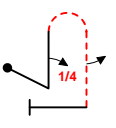
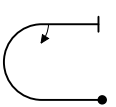
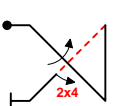
FREE PROGRAM CHECKED BY:

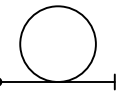
Signature:	Printed Name:	Date:
		IAC No.

Judge Name:

IAC#

Assistant Name:

IAC#



Pilot NAC



B	Contest:	Category: Intermediate	
	Date:	Program: Unknown	Pilot's No. <input type="text"/>

wind direction

Pilot
NAC

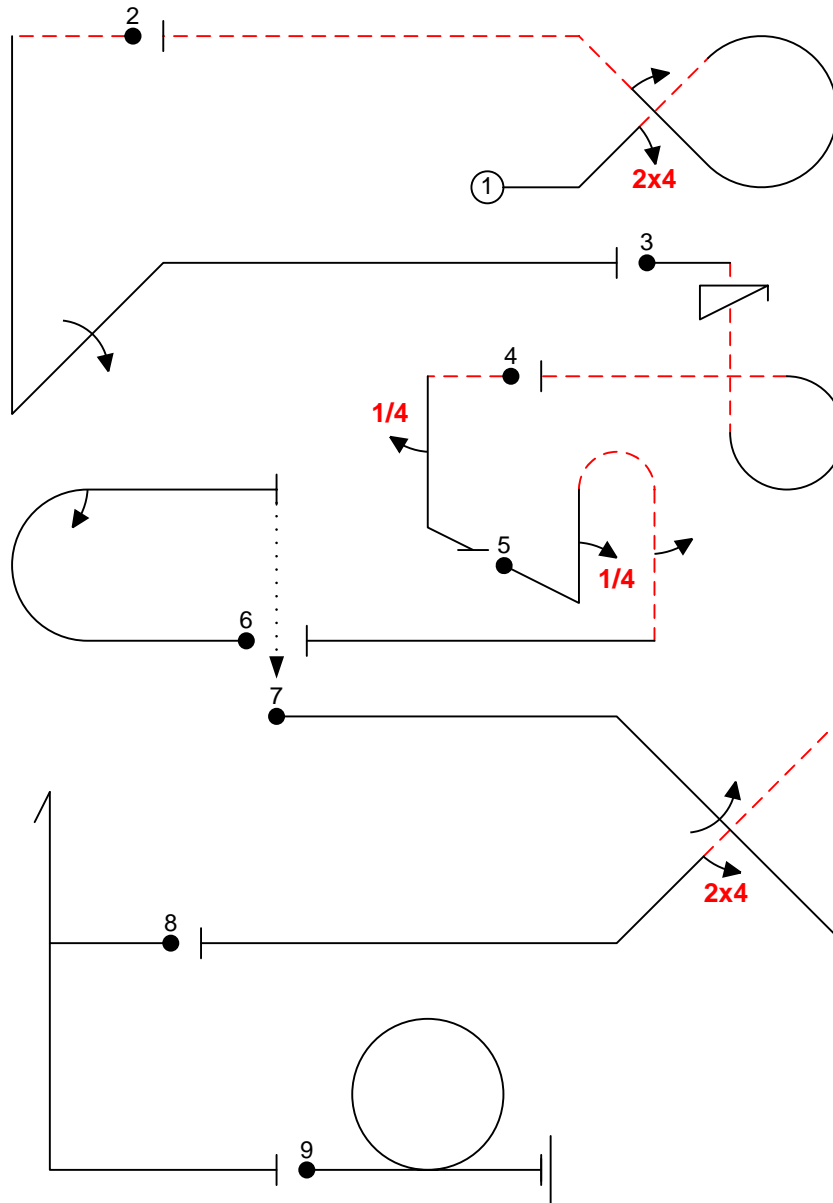

A/C:

(signature/date)

FREE PROGRAM CHECK BY:



C	Contest:	Category: Intermediate	
Date:	Program: Unknown	Pilot's No.	

pilot
NAC

wind direction

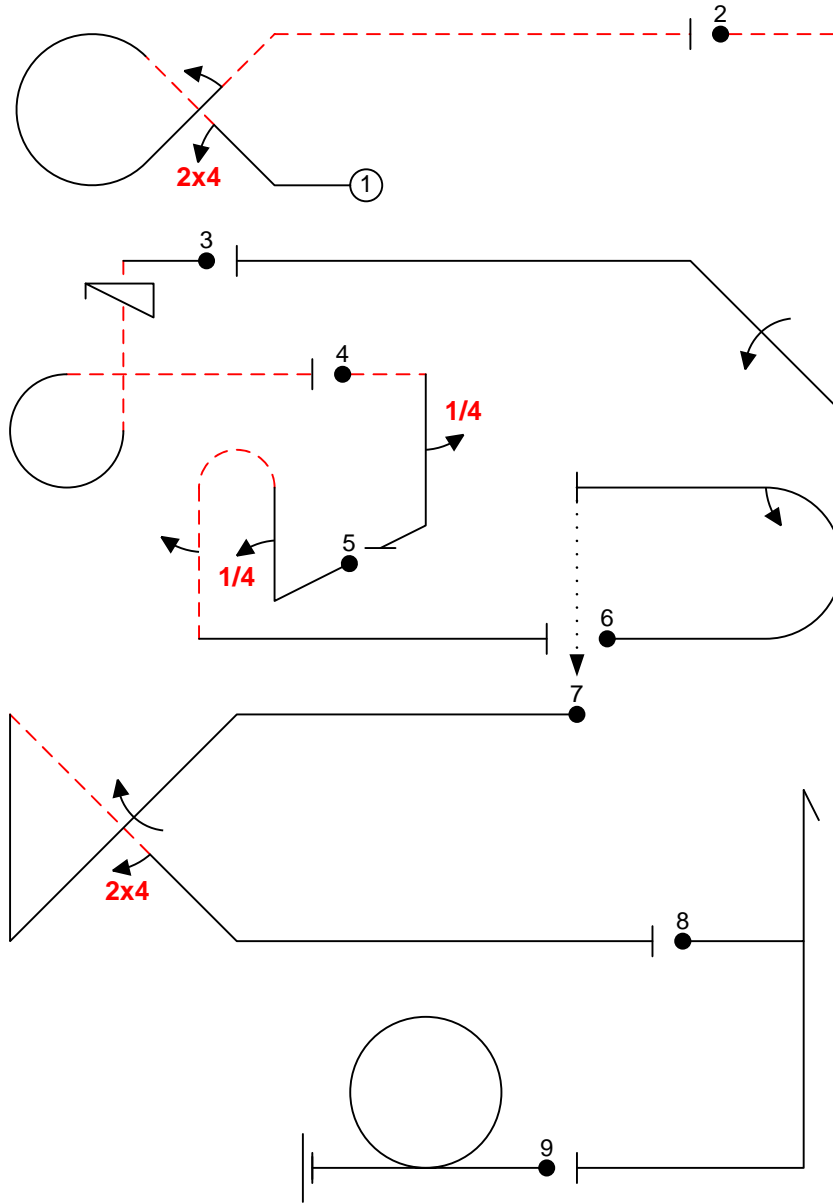

A/C:

(signature/date)

FREE PROGRAM CHECK BY: