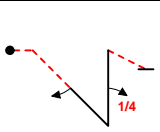
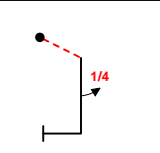
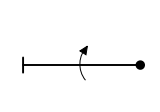
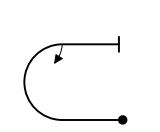
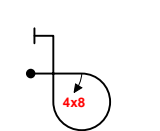
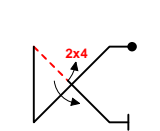
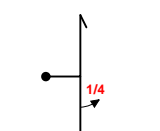
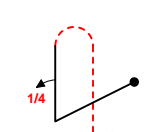
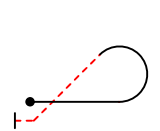
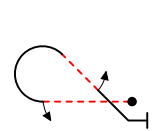

INTERNATIONAL AEROBATIC CLUB SCORESHEET

A

Contest:	Date:	Category: Intermediate	Programme: Unknown	pilot's number	
----------	-------	----------------------------------	------------------------------	----------------	--

No	Symbol	Catalogue No.	K	Total K	Grade	Remarks
1		1.2.3.4 9.1.4.2 9.1.1.1	12 4 6	22		
2		1.1.7.4 9.1.5.1	9 2	11		
3		1.1.1.1 9.1.3.4	2 8	10		
4		7.2.2.1 9.1.3.4	6 4	10		
5		8.6.8.3 9.8.3.2	12 7	19		
6		1.3.3.3 9.1.4.4 9.4.4.2	18 8 5	31		
7		5.2.1.1 9.1.5.1	17 2	19		
8		8.4.3.1 9.1.1.1	15 6	21		
9		8.5.5.1	10	10		
10		8.5.8.2 9.1.3.2 9.1.4.2	11 4 4	19		

Presentation	8	
---------------------	----------	--

FIGURE TOTAL K = **172**

INCLUDING PRESENTATION = **180**

Aircraft Type:

FREE PROGRAM CHECKED BY:

Signature:	Printed Name:	Date:
IAC No.		

Judge Name:

IAC#

Assistant Name:

IAC#



Pilot NAC



B	Contest:	Category: Intermediate	
	Date:	Program: Unknown	Pilot's No. <input type="text"/>

wind direction

Pilot
NAC

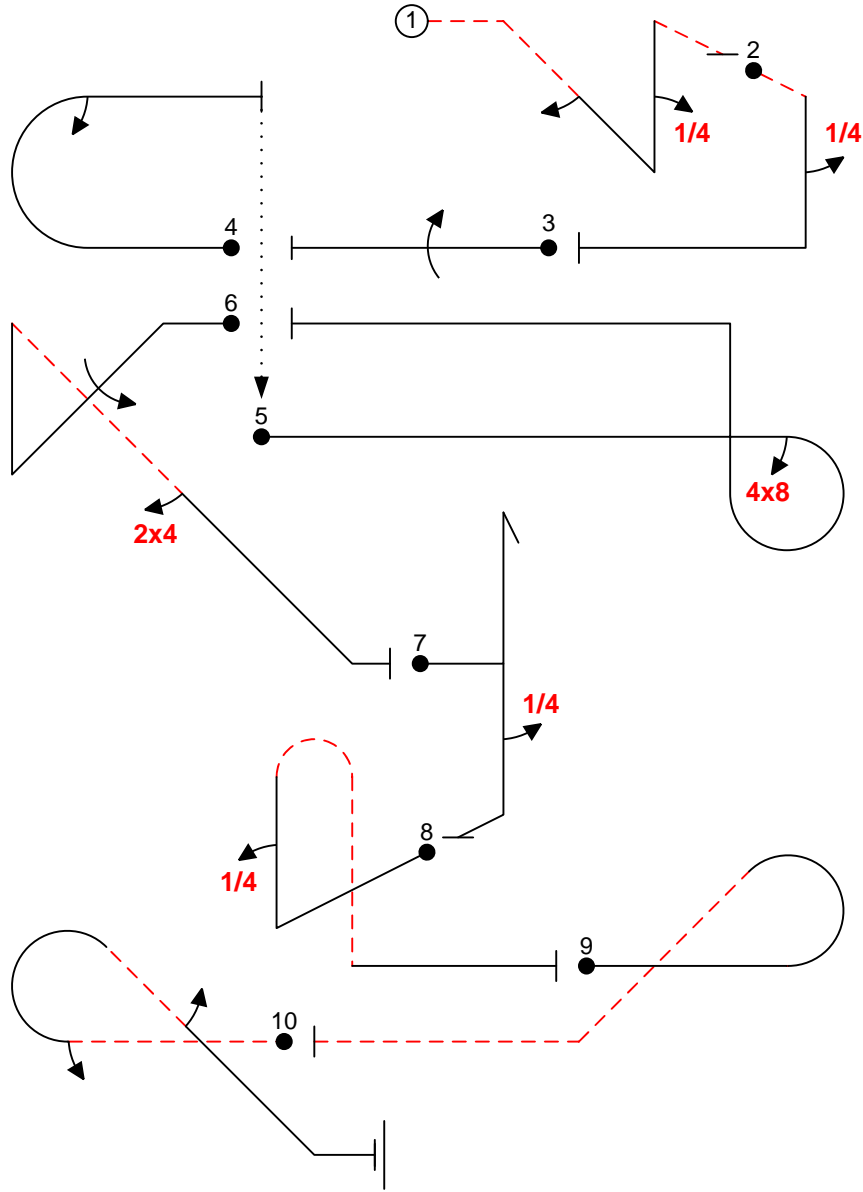

A/C:

(signature/date)

FREE PROGRAM CHECK BY:



C	Contest:	Category: Intermediate	
	Date:	Program: Unknown	Pilot's No. <input type="text"/>

pilot
NAC

wind direction

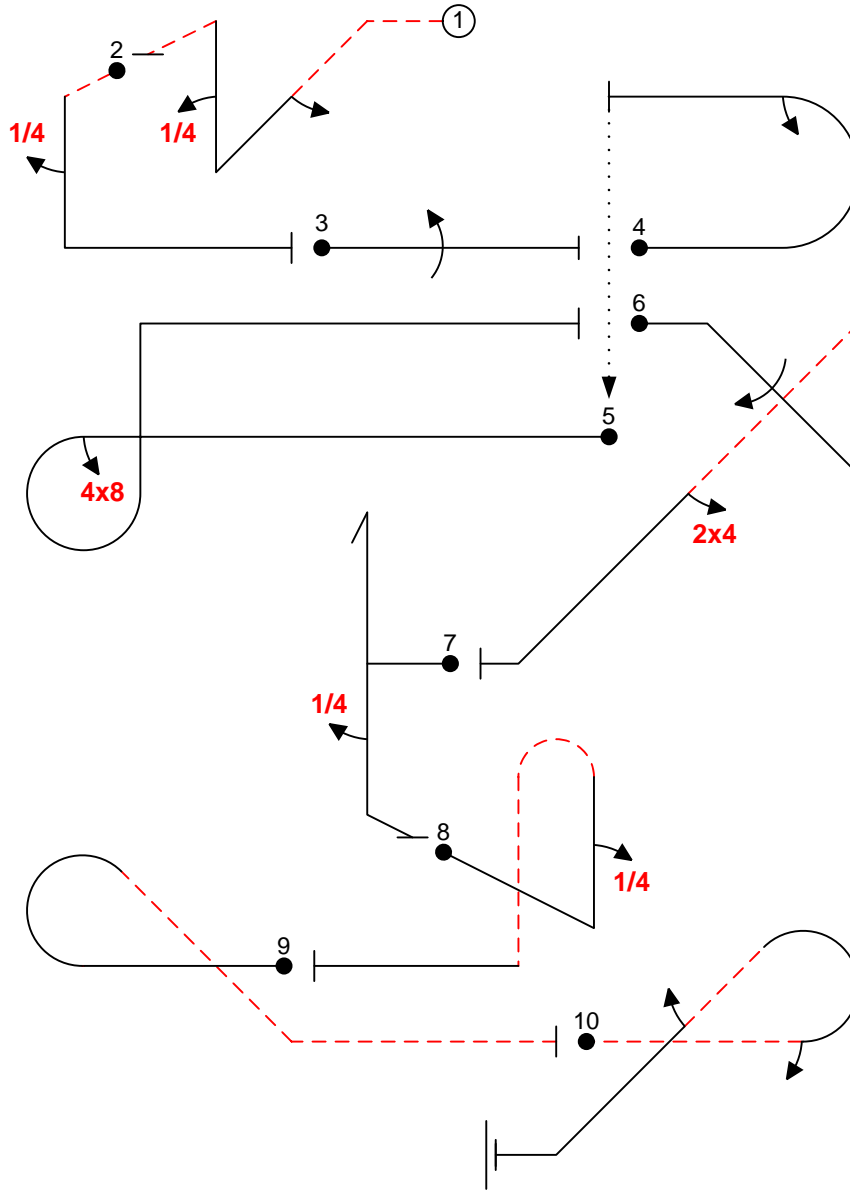

A/C:

(signature/date)

FREE PROGRAM CHECK BY: