

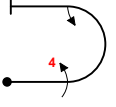

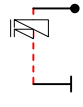
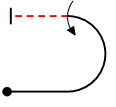

INTERNATIONAL AEROBATIC CLUB SCORESHEET

A	Contest:	Date:	Category: Intermediate	Programme: Unknown	pilot's number	

No	Symbol	Catalogue No.	K	Total K	Grade	Remarks
1		7.2.2.1 9.4.3.4 9.1.3.2	6 11 4	21		
2		1.1.6.3 9.11.1.6	10 3	13		
3		7.2.1.1 9.1.3.4	6 8	14		
4		7.3.4.4 9.1.4.2 9.4.4.2	15 4 5	24		
5		7.4.3.1	14	14		
6		5.2.1.1 9.1.5.1	17 2	19		
7		5.2.1.1 9.1.1.1 9.1.5.2	17 6 4	27		
8		1.1.7.1	9	9		
9		1.2.5.4 9.1.2.4	14 10	24		
10		8.5.1.3	10	10		

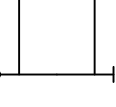
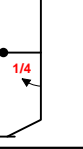
Presentation	8	
---------------------	----------	--

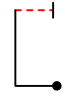
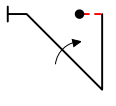
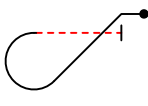
FIGURE TOTAL K =	175
INCLUDING PRESENTATION =	183

Aircraft Type:

FREE PROGRAM CHECKED BY:

Signature:	Printed Name:	Date:
IAC No.		

Judge Name:

IAC#

Assistant Name:

IAC#



Pilot NAC



B	Contest:	Category: Intermediate
Date:	Program: Unknown	Pilot's No. <input type="text"/>

wind direction

Pilot
NAC

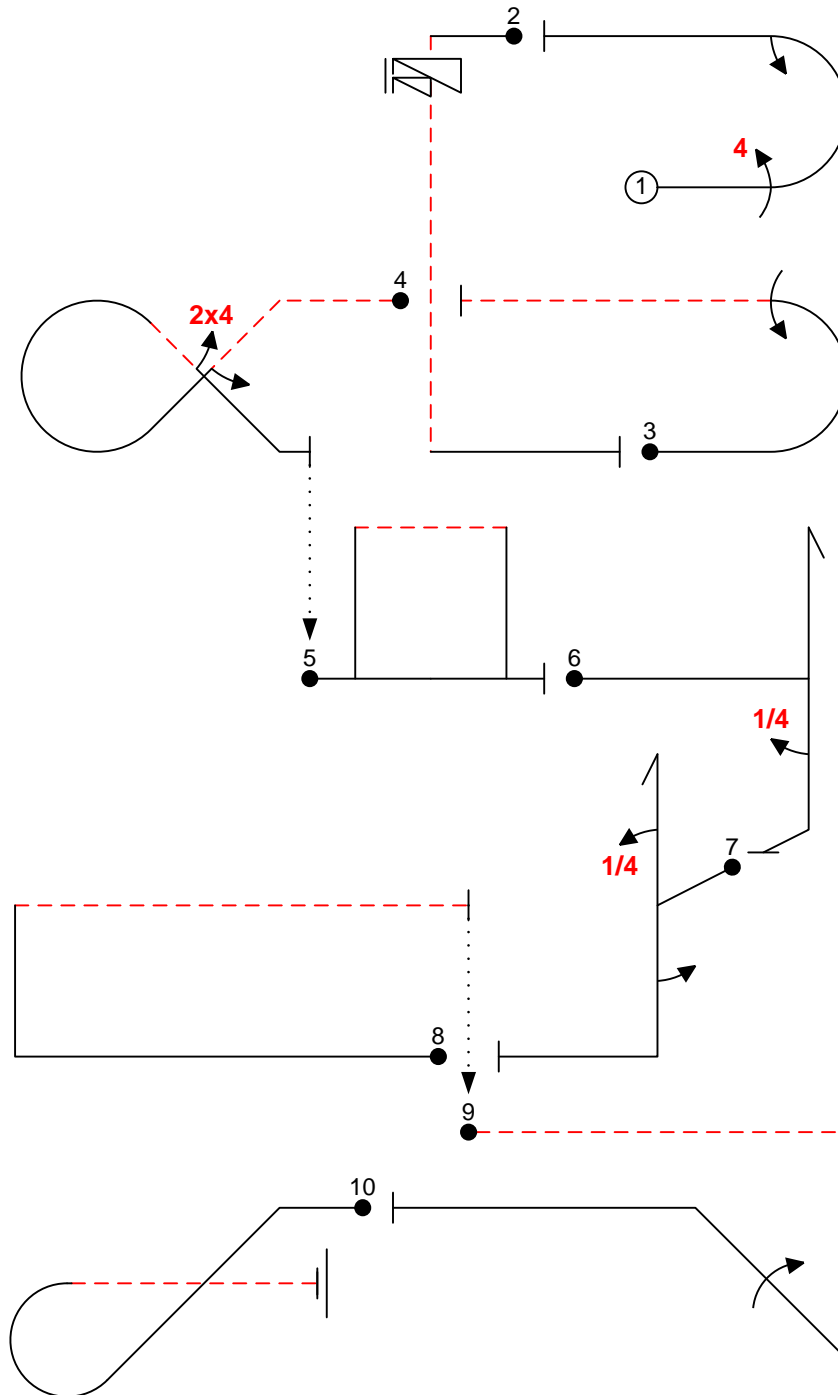

A/C:

(signature/date)

FREE PROGRAM CHECK BY:



C	Contest:	Category: Intermediate	
	Date:	Program: Unknown	Pilot's No. <input type="text"/>

pilot
NAC

wind direction

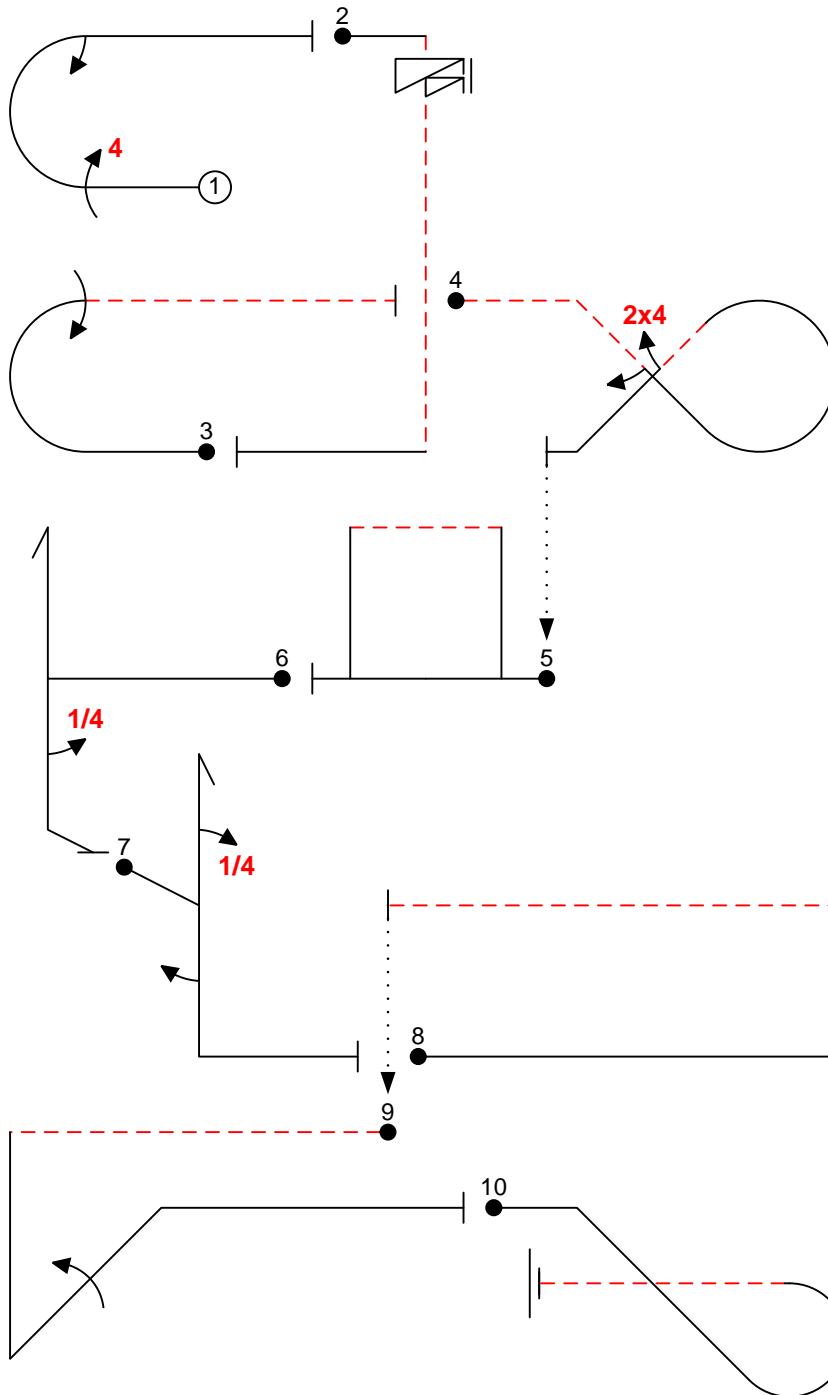

Created Using Aresti 2013™ software. ACCassidy@aol.com

A/C:

(signature/date)

FREE PROGRAM CHECK BY: