

INTERNATIONAL AEROBATIC CLUB SCORESHEET

A	Contest:	Date:	Category: Intermediate	Programme: Unknown	pilot's number	



No	Symbol	Catalogue No.	K	Total K	Grade	Remarks	Item	K	Score
1		1.1.3.1 9.4.2.2	7 7	14			Presentation	8	
2		1.1.7.4 9.1.5.1	9 2	11					
3		1.1.6.1 9.1.1.1	10 6	16					
4		1.1.6.3 9.1.1.4	10 5	15					
5		7.2.1.1	6	6					
6		1.1.1.4 9.1.3.6	2 10	12					
7		8.5.6.1 9.1.3.4 9.4.4.2	10 8 5	23					
8		8.4.1.1 9.1.5.2	13 4	17					
9		7.4.1.1 9.9.3.4	10 11	21					
10		5.2.1.1 9.1.5.1	17 2	19					
11		8.4.3.1 9.1.1.1	15 6	21					

FIGURE TOTAL K = 175

INCLUDING PRESENTATION = 183

Aircraft Type:

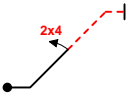
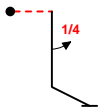
FREE PROGRAM CHECKED BY:

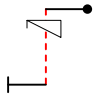
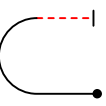
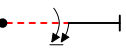
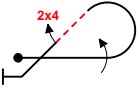
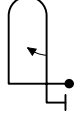
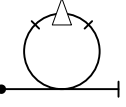
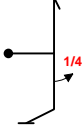
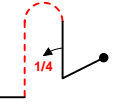
Signature:	Printed Name:	Date:
		IAC No.

Judge
Name
Number



pilot



B	Contest:	Category: Intermediate
Date:	Program: Unknown	Pilot's No. <input type="text"/>

wind direction

Pilot:

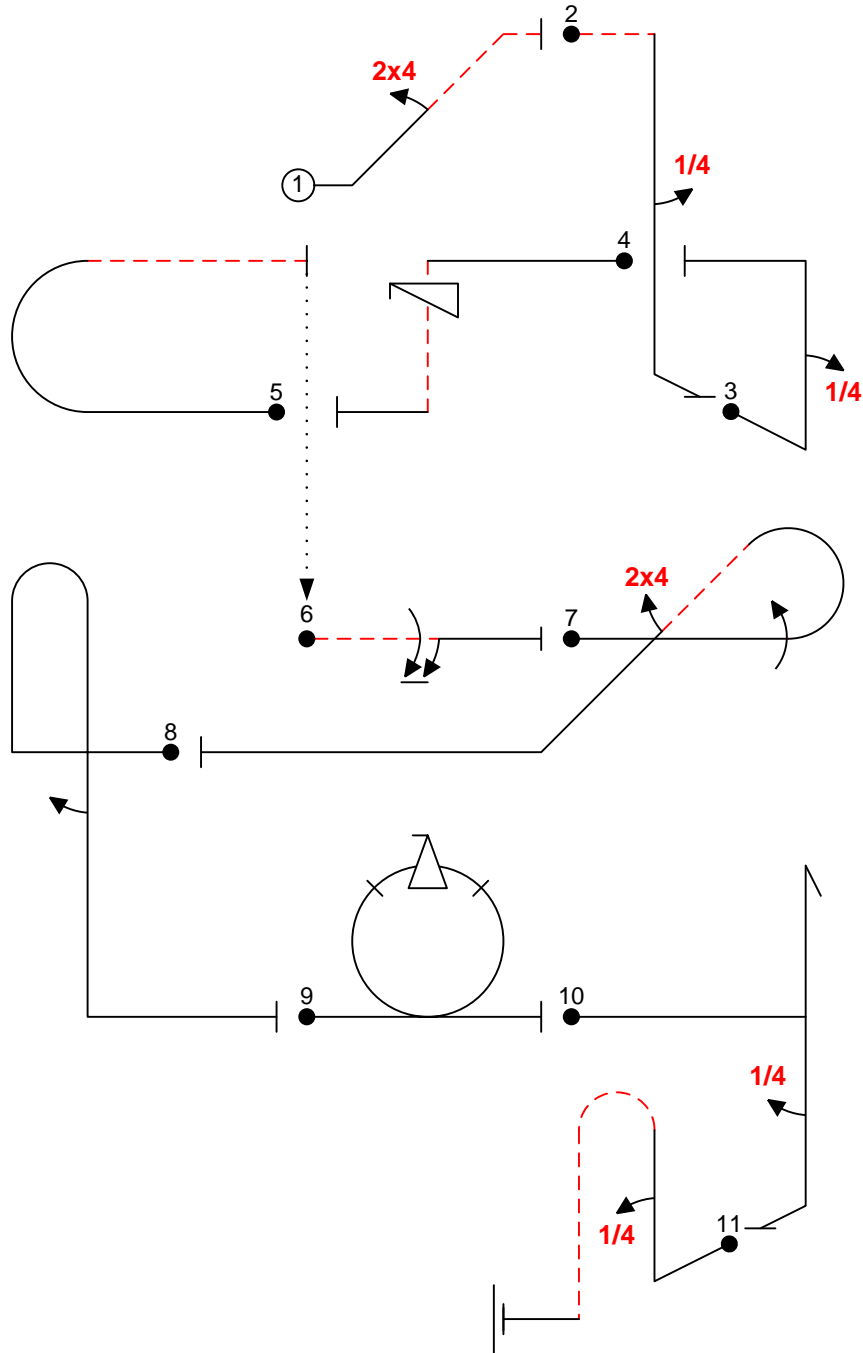

A/C:

(signature/date)

FREE PROGRAM CHECK BY:

Created Using Aresti 2013™ software. ACCassidy@aol.com



C	Contest:	Category: Intermediate
Date:	Program: Unknown	Pilot's No. <input type="text"/>

wind direction

Pilot:

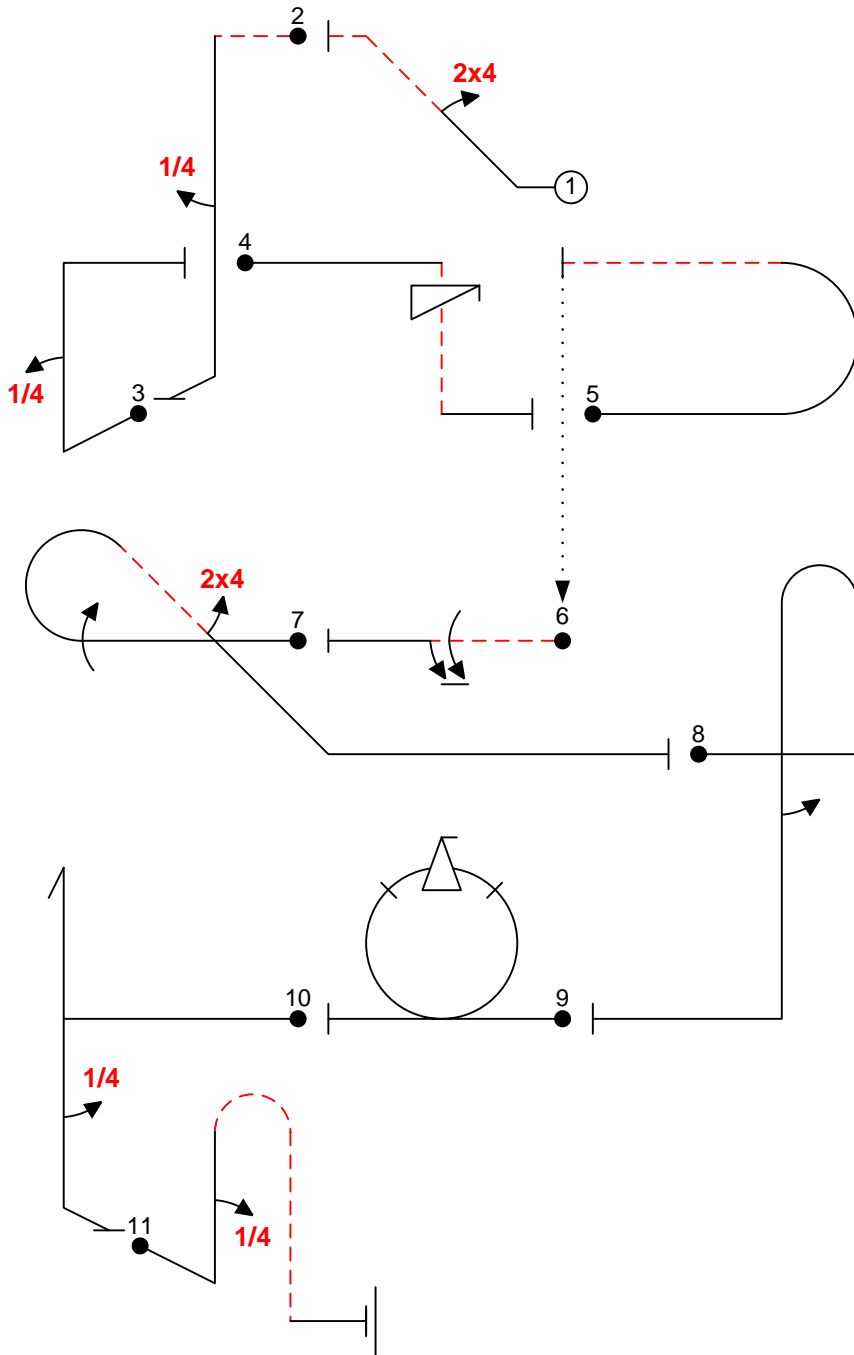

A/C:

(signature/date)

FREE PROGRAM CHECK BY:

Created Using Aresti 2013™ software. ACCassidy@aol.com