

INTERNATIONAL AEROBATIC CLUB SCORESHEET

A	Contest:	Date:	Category: Intermediate	Programme: Unknown	pilot's number	









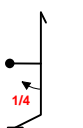

No	Symbol	Catalogue No.	K	Total K	Grade	Remarks	Item	K	Score
1		5.2.1.1 9.1.5.1	17 2	19			Presentation	8	
2		8.4.3.1 9.1.1.1	15 6	21					
3		8.4.3.1 9.1.5.1	15 2	17					
4		1.1.6.1 9.1.1.1	10 6	16					
5		1.1.6.3 9.11.1.4	10 5	15					
6		7.2.2.1 9.1.3.2	6 4	10					
7		1.1.1.1 9.1.3.4	2 8	10					
8		7.2.3.3 9.4.3.2	6 5	11					
9		7.4.1.1 9.9.3.4	10 11	21					
10		2.2.1.1	4	4					
11		8.7.5.1 9.2.3.4	11 9	20					
12		7.2.1.1	6	6					

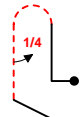
FIGURE TOTAL K =

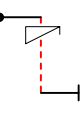
INCLUDING PRESENTATION =

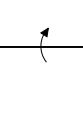
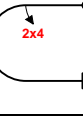
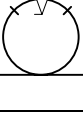
Aircraft Type:

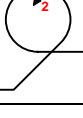
FREE PROGRAM CHECKED BY:

Signature:	Printed Name:	Date:
		IAC No.

Judge
Name
Number



pilot



B	Contest:	Category: Intermediate
Date:	Program: Unknown	Pilot's No. <input type="text"/>

wind direction

Pilot:

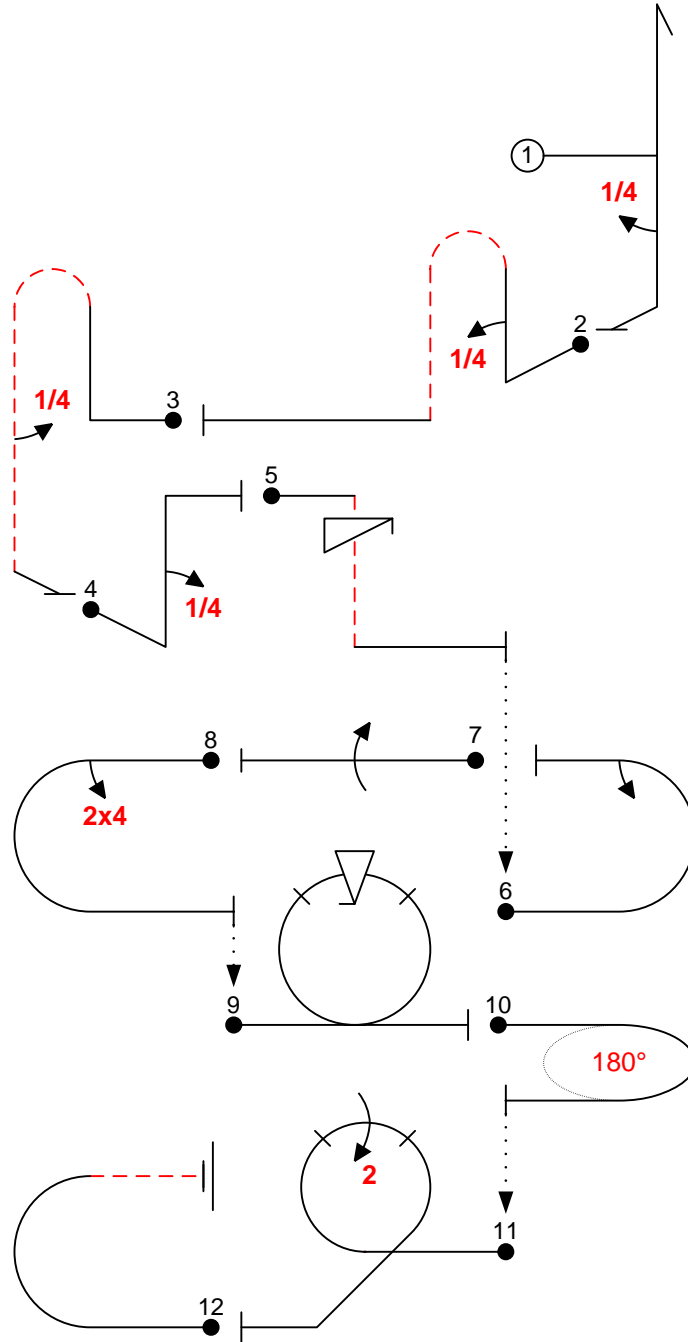

A/C:

FREE PROGRAM CHECK BY: (signature/date)

FREE PROGRAM CHECK BY: (signature/date)



C	Contest:	Category: Intermediate
Date:	Program: Unknown	Pilot's No. <input type="text"/>

wind direction

Pilot: _____

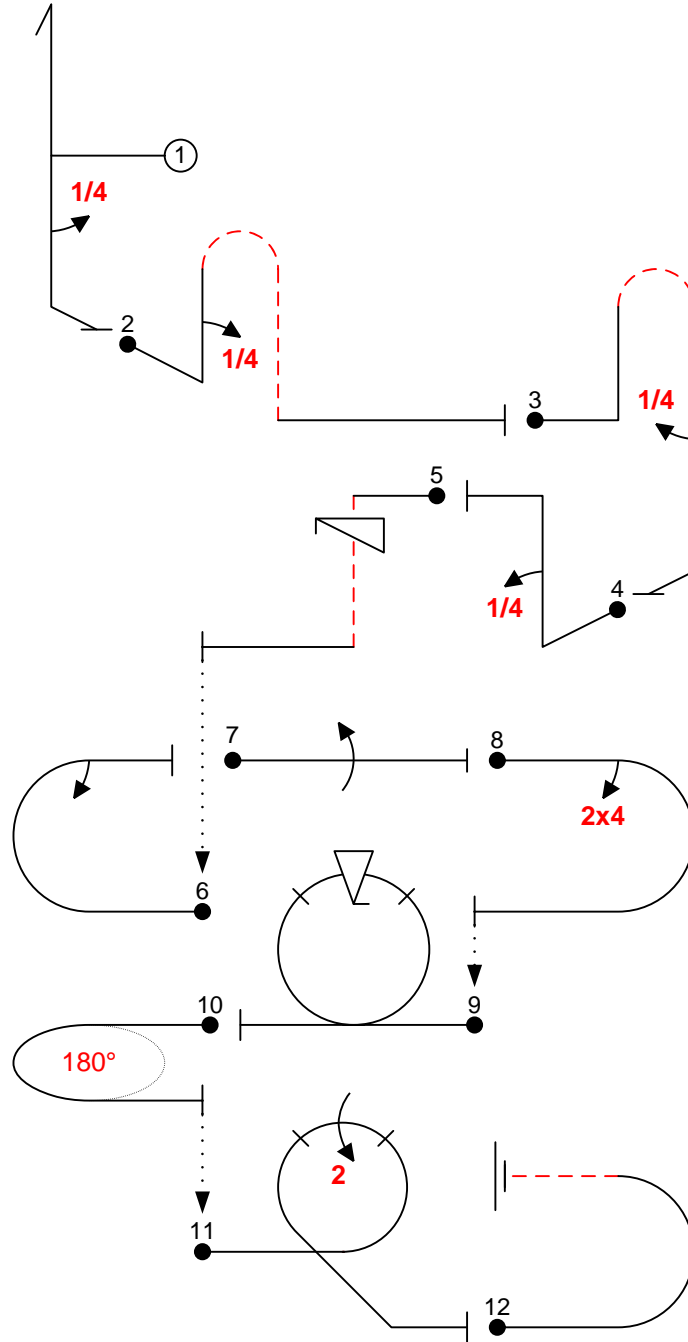

A/C: _____

FREE PROGRAM CHECK BY: (signature/date) _____

FREE PROGRAM CHECK BY: (signature/date) _____