

INTERNATIONAL AEROBATIC CLUB SCORESHEET

<b>A</b>	Contest:	Date:	Category: <b>Intermediate</b>	Programme: <b>Unknown</b>	pilot's number	

No	Symbol	Catalogue No.	K	Total K	Grade	Remarks	Item	K	Score
1		1.6.3 9.11.1.5	10 4	14			<b>Presentation</b>	<b>8</b>	
2		7.2.1 9.1.3.4 9.8.3.2	6 8 7	21					
3		2.2.1	4	4					
4		1.2.3 9.9.4.4	7 11	18					
5		8.3.1 9.1.1.1 9.1.5.2	15 6 4	25					
6		5.1.1 9.1.5.1	17 2	19					
7		7.20.1 9.1.2.2	14 6	20					
8		1.13.3 9.1.1.1	12 6	18					
9		2.2.4	4	4					
10		1.3.4 9.4.4.2	7 5	12					
11		7.2.1 9.1.3.2	6 4	10					
12		1.1.1 9.1.3.4	2 8	10					

FIGURE TOTAL K =

INCLUDING PRESENTATION =

Aircraft Type:

FREE PROGRAM CHECKED BY:

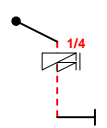
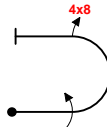
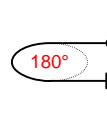
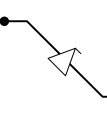
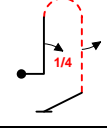
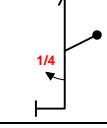
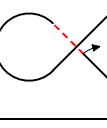
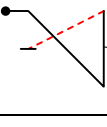
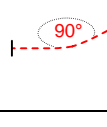
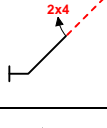
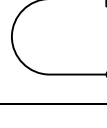
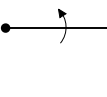
Signature:	Printed Name:	Date:
		IAC No.

Judge
Name
Number



pilot



<b>B</b>	Contest:	Category: <b>Intermediate</b>
Date:	Program: <b>Unknown</b>	Pilot's No. <input type="text"/>

wind direction

Pilot:

NOTE CROSS-BOX START

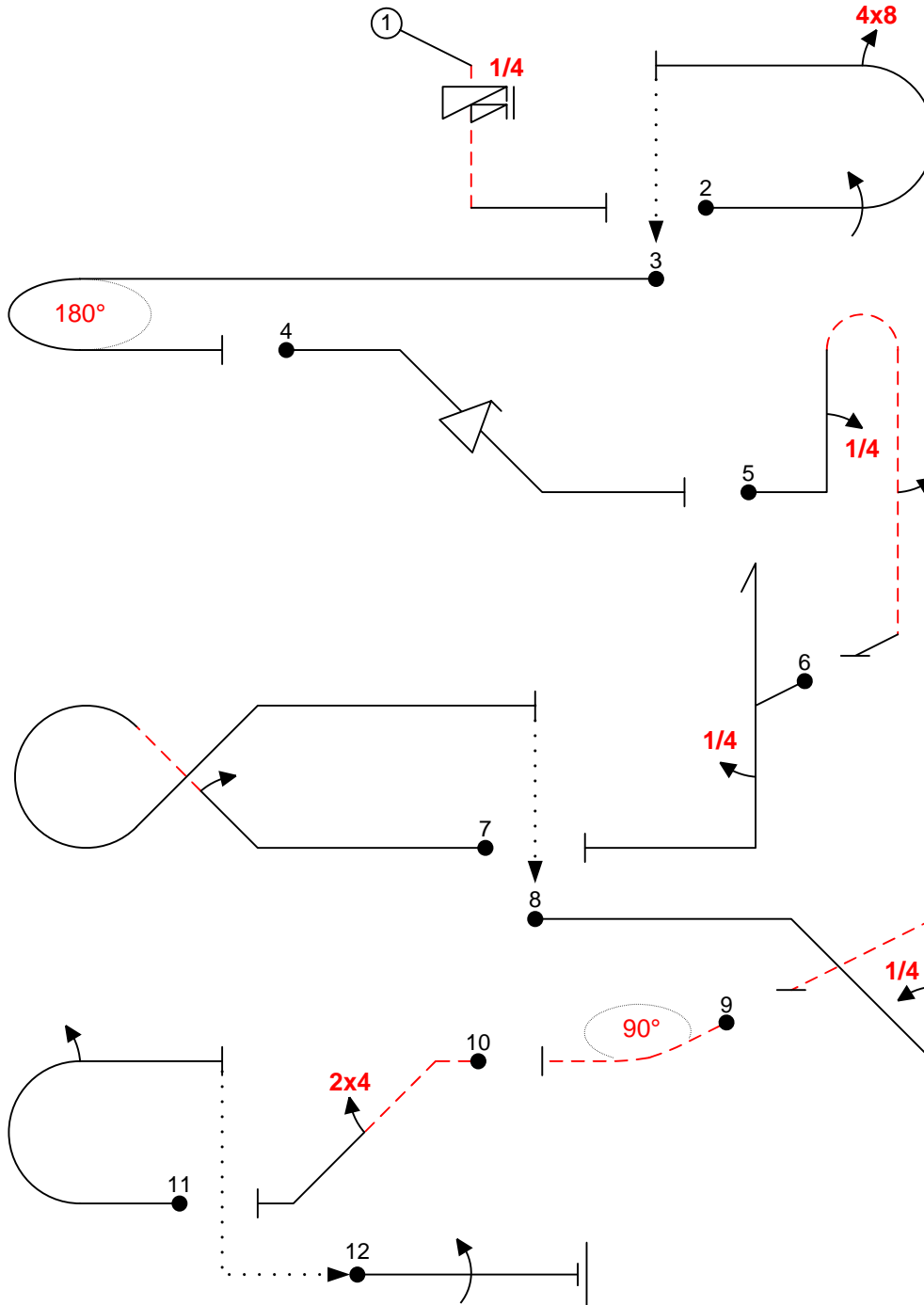

A/C:

(signature/date)

FREE PROGRAM CHECK BY:



<b>C</b>	Contest:	Category: <b>Intermediate</b>	
	Date:	Program: <b>Unknown</b>	Pilot's No. <input type="text"/>

wind direction

NOTE CROSS-BOX START

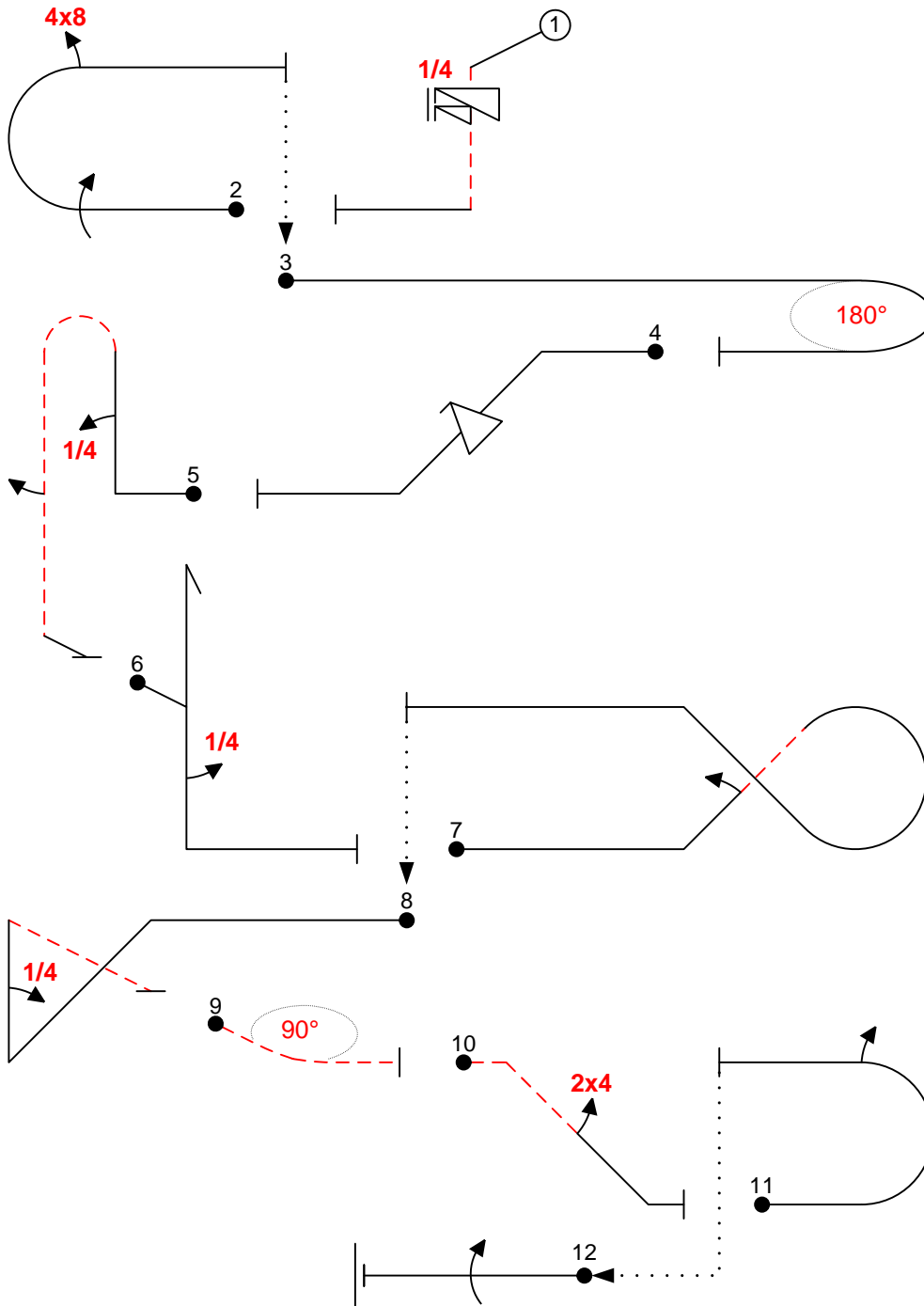

Created Using Aresti 2010™ software. ACCassidy@aol.com

A/C: \_\_\_\_\_

FREE PROGRAM CHECK BY: (signature/date) \_\_\_\_\_

FREE PROGRAM CHECK BY: (signature/date) \_\_\_\_\_