

INTERNATIONAL AEROBATIC CLUB SCORESHEET

A	Contest:	Date:	Category: Intermediate	Programme: Unknown	pilot's number	





No	Symbol	Catalogue No.	K	Total K	Grade	Remarks	Item	K	Score
1		1.2.1 9.9.2.4	7 13	20			Presentation	8	
2		1.25.3 9.11.1.4	17 5	22					
3		1.7.4 9.1.5.1	9 2	11					
4		8.3.1 9.1.1.1	15 6	21					
5		5.1.1 9.1.5.1	17 2	19					
6		2.2.3	3	3					
7		7.1.1	6	6					
8		7.25.4 9.4.3.4 9.1.2.2	19 11 6	36					
9		7.3.3 9.4.3.2	6 5	11					
10		7.7.1	14	14					
11		1.1.3 9.1.3.6	2 10	12					

FIGURE TOTAL K = **175**

INCLUDING PRESENTATION = **183**

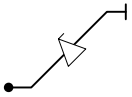
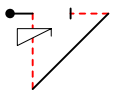
Aircraft Type:

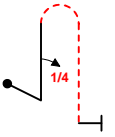
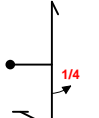
FREE PROGRAM CHECKED BY:

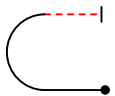
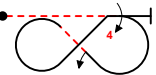
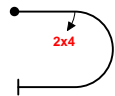
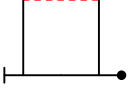
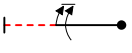
Signature:	Printed Name:	Date:
		IAC No.

Judge
Name
Number



pilot



B	Contest:	Category: Intermediate
Date:	Program: Unknown	Pilot's No. <input type="text"/>

wind direction

Pilot:

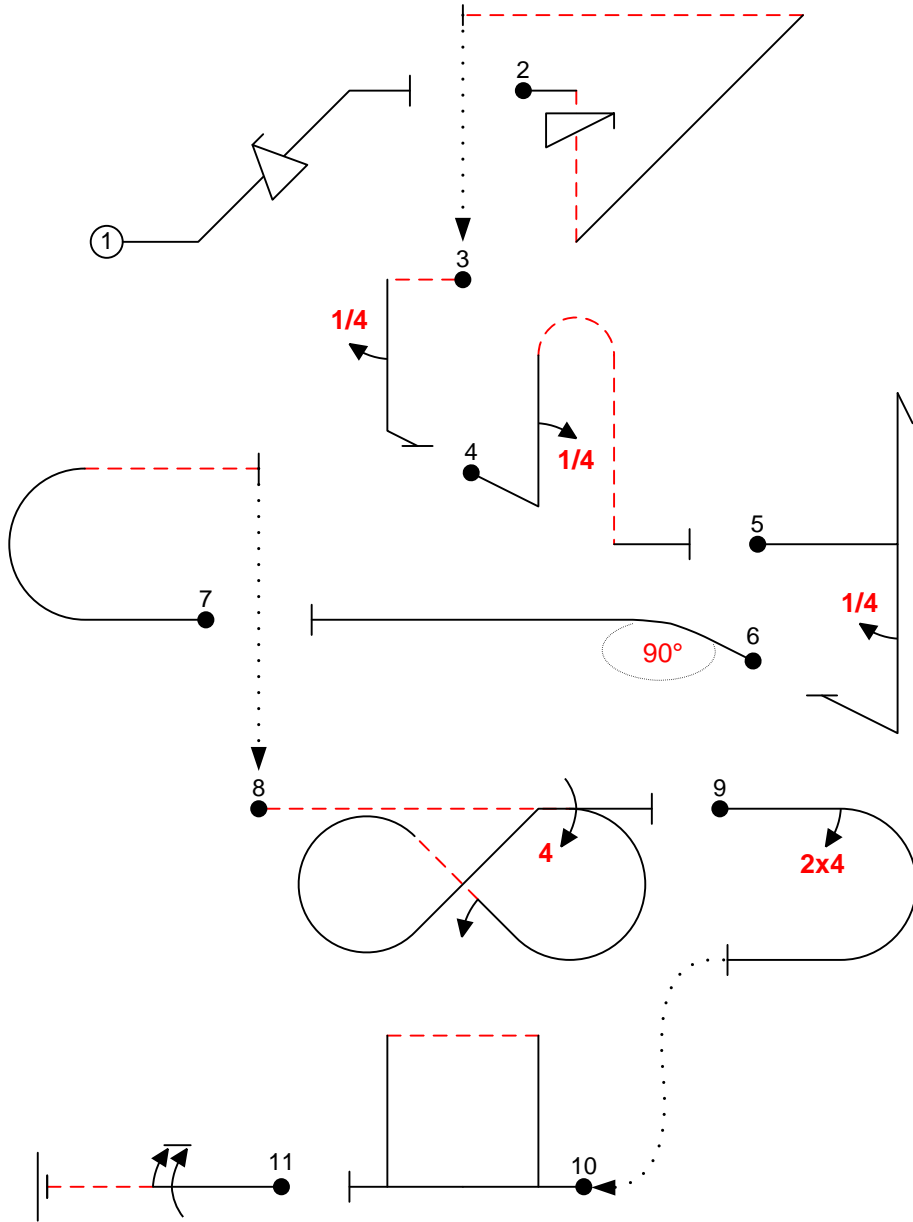

A/C:

(signature/date)

FREE PROGRAM CHECK BY:



C	Contest:	Category: Intermediate
Date:	Program: Unknown	Pilot's No. <input type="text"/>

Pilot:

wind direction

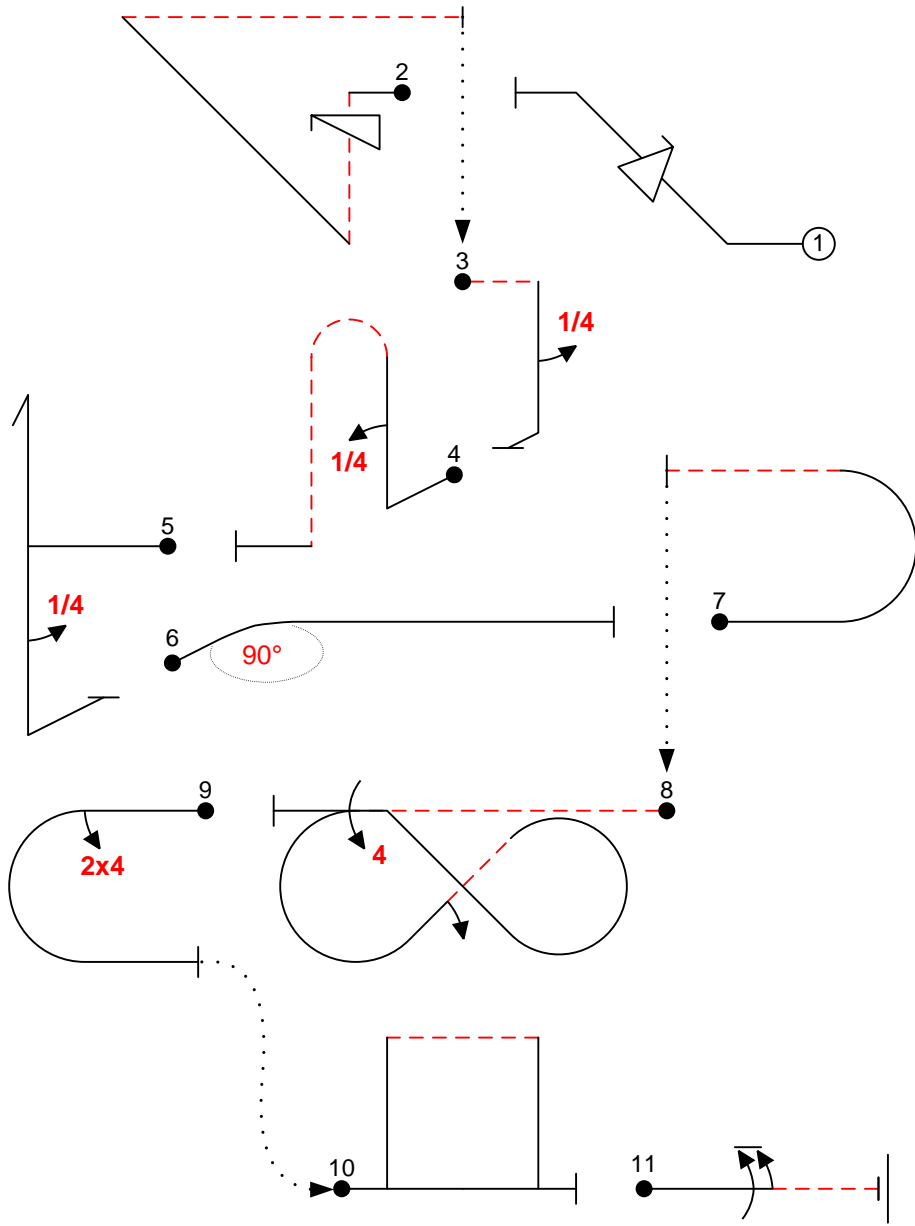

A/C:

(signature/date)

FREE PROGRAM CHECK BY: