

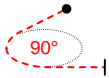
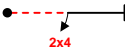
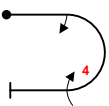
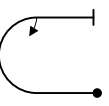
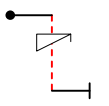
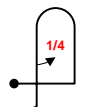
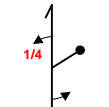
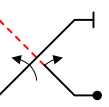
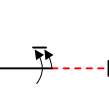
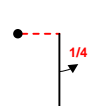

INTERNATIONAL AEROBATIC CLUB SCORESHEET

A	Contest:	Date:	Category: Intermediate	Programme: Unknown	pilot's number	

No	Symbol	Catalogue No.	K	Total K	Grade	Remarks
1		2.2.4	4	4		
2		1.1.4 9.4.3.2	2 5	7		
3		7.3.3 9.1.3.2 9.4.3.4	6 4 11	21		
4		7.2.1 9.1.3.2	6 4	10		
5		1.6.3 9.11.1.4	10 5	15		
6		8.1.1 9.1.5.1	13 2	15		
7		5.1.1 9.1.1.1 9.1.5.2	17 6 4	27		
8		1.29.1 9.1.2.2 9.1.2.4	18 6 10	34		
9		1.1.3 9.1.3.6	2 10	12		
10		1.7.4 9.1.5.1	9 2	11		
11		8.3.1 9.1.5.1	15 2	17		

Item	K	Score
Presentation	8	

FIGURE TOTAL K = 173

INCLUDING PRESENTATION = 181

Aircraft Type:

FREE PROGRAM CHECKED BY:

Signature:	Date:
	IAC No.

Judge
Name
Number



pilot



B	Contest:	Category: Intermediate
Date:	Program: Unknown	Pilot's No. <input type="text"/>

wind direction

Pilot:

NOTE Y-AXIS START

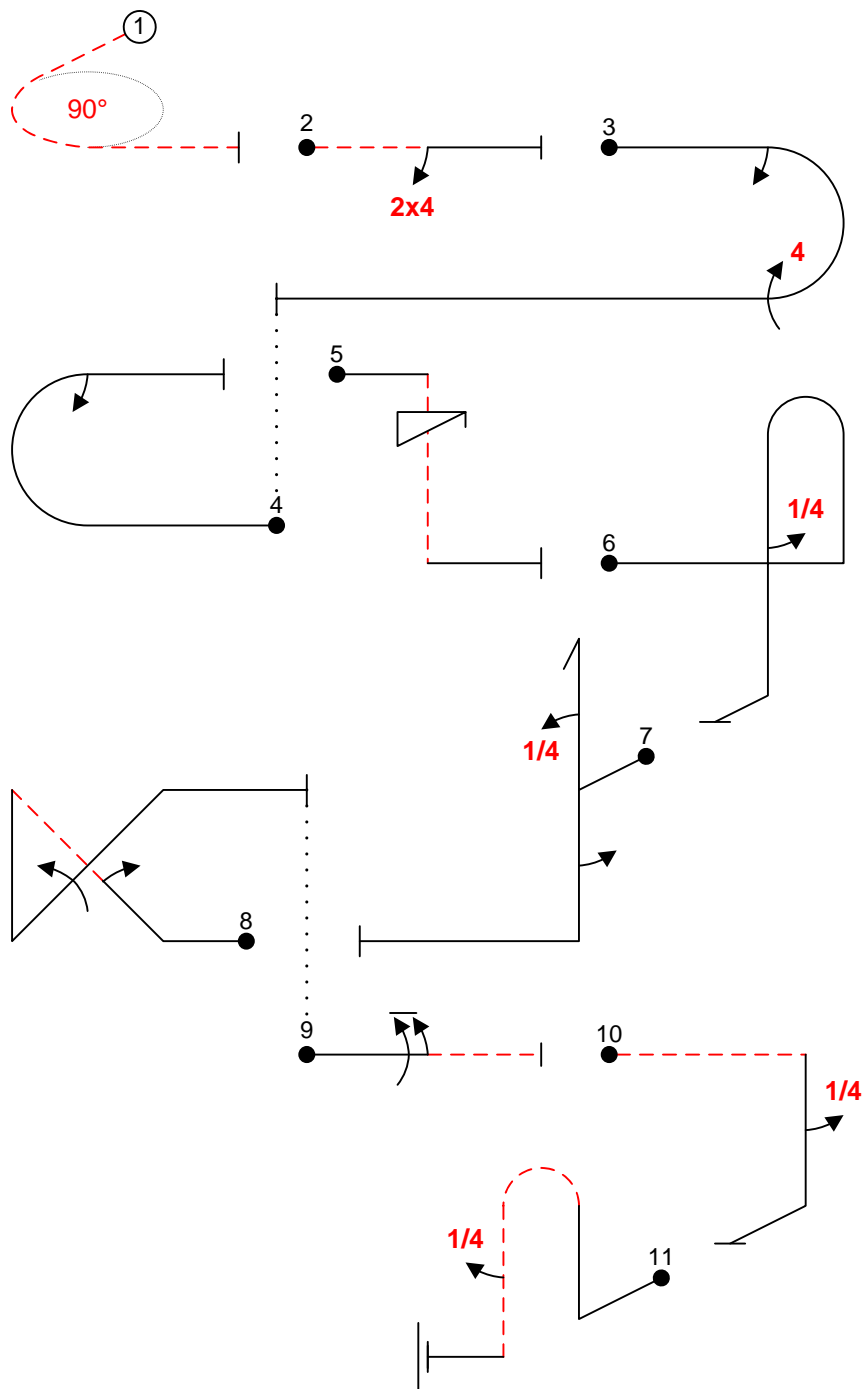

A/C:

(signature/date)

FREE PROGRAM CHECK BY:



C	Contest:	Category: Intermediate
Date:	Program: Unknown	Pilot's No. <input type="text"/>

Pilot: _____

wind direction

NOTE Y-AXIS START

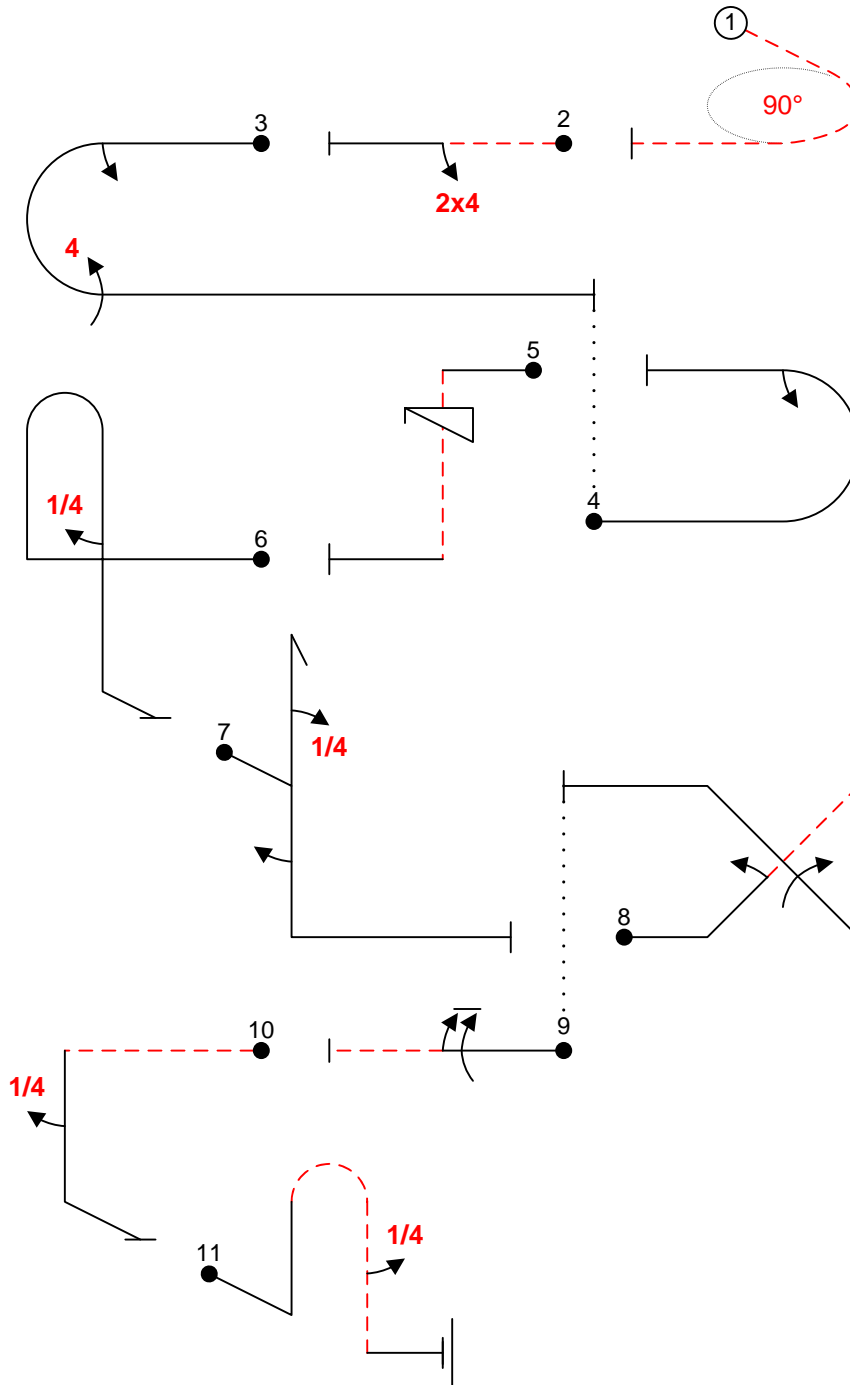

A/C: _____

FREE PROGRAM CHECK BY: (signature/date) _____

FREE PROGRAM CHECK BY: (signature/date) _____