

INTERNATIONAL AEROBATIC CLUB SCORESHEET

**A**

Contest:

Date:

Category:

Programme:

pilot's number

**Intermediate**

**Unknown**

| No | Symbol  | Catalogue No.               | K            | Total K | Grade | Remarks | Item                | K        | Grade |
|----|---|-----------------------------|--------------|---------|-------|---------|---------------------|----------|-------|
| 1  |    | 5.1.1<br>9.1.1.1            | 17<br>6      | 23      |       |         | <b>Presentation</b> | <b>8</b> |       |
| 2  |    | 7.2.1<br>9.4.3.2            | 6<br>5       | 11      |       |         |                     |          |       |
| 3  |    | 1.1.1<br>9.2.3.4            | 2<br>9       | 11      |       |         |                     |          |       |
| 4  |    | 1.6.3<br>9.11.1.6           | 10<br>3      | 13      |       |         |                     |          |       |
| 5  |    | 8.1.1<br>9.1.1.1<br>9.1.5.1 | 13<br>6<br>2 | 21      |       |         |                     |          |       |
| 6  |   | 1.6.1<br>9.1.1.1            | 10<br>6      | 16      |       |         |                     |          |       |
| 7  |  | 2.2.3                       | 3            | 3       |       |         |                     |          |       |
| 8  |  | 1.1.1<br>9.9.3.4            | 2<br>11      | 13      |       |         |                     |          |       |
| 9  |  | 7.3.3<br>9.4.3.2<br>9.1.3.4 | 6<br>5<br>8  | 19      |       |         |                     |          |       |
| 10 |  | 8.15.1<br>9.1.2.2           | 12<br>6      | 18      |       |         |                     |          |       |
| 11 |  | 7.5.1                       | 10           | 10      |       |         |                     |          |       |
| 12 |  | 8.39.1<br>9.4.3.2           | 12<br>5      | 17      |       |         |                     |          |       |

FIGURE TOTAL K = **175**

INCLUDING PRESENTATION = **183**

Aircraft Type:

FREE PROGRAM CHECKED BY:

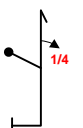
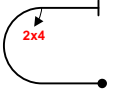
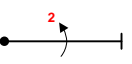
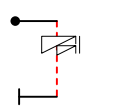
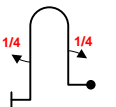
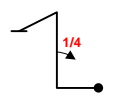
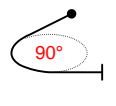
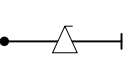
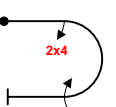
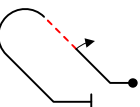
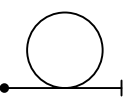
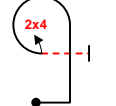
|            |         |
|------------|---------|
| Signature: | Date:   |
|            | IAC No. |

|        |
|--------|
| Judge  |
| Name   |
| Number |



pilot



|          |                         |                                  |
|----------|-------------------------|----------------------------------|
| <b>B</b> | Contest:                | Category: <b>Intermediate</b>    |
| Date:    | Program: <b>Unknown</b> | Pilot's No. <input type="text"/> |

wind direction

Pilot:

NOTE Y AXIS ENTRY

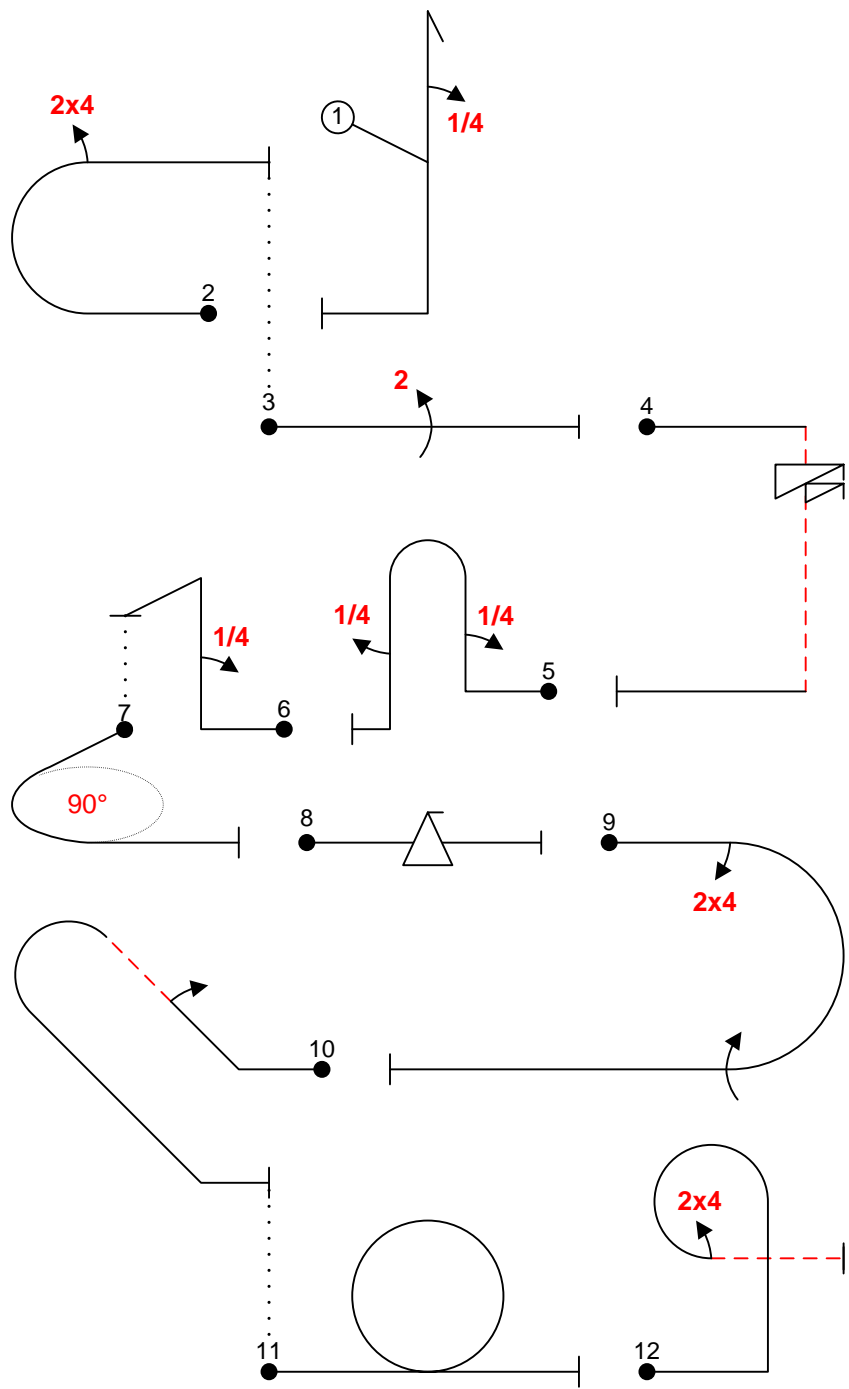

A/C:

(signature/date)

FREE PROGRAM CHECK BY:



|          |                         |                                  |
|----------|-------------------------|----------------------------------|
| <b>C</b> | Contest:                | Category: <b>Intermediate</b>    |
| Date:    | Program: <b>Unknown</b> | Pilot's No. <input type="text"/> |

wind direction

NOTE Y AXIS ENTRY

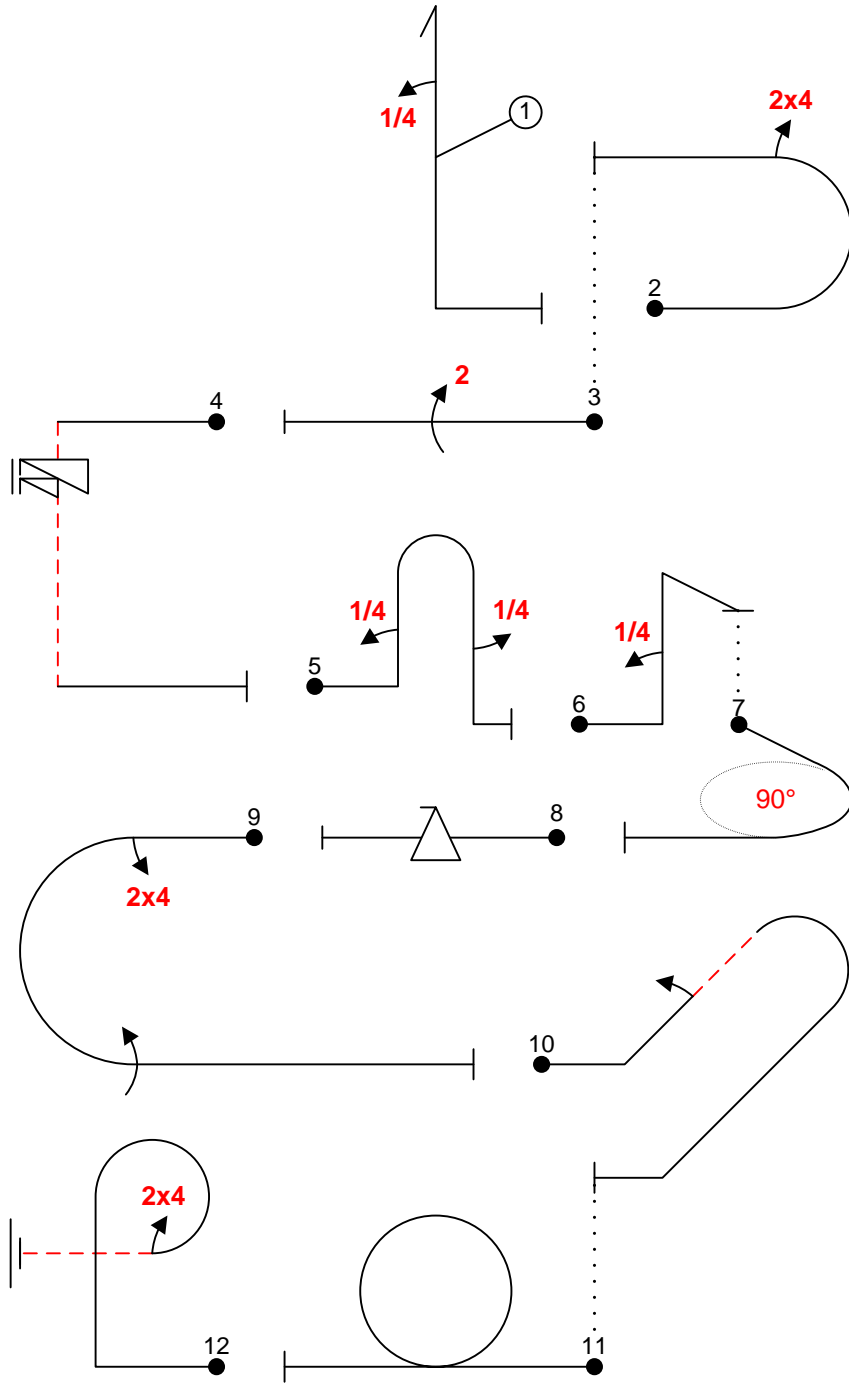

Pilot: \_\_\_\_\_

A/C: \_\_\_\_\_

(signature/date)

FREE PROGRAM CHECK BY: \_\_\_\_\_