

INTERNATIONAL AEROBATIC CLUB SCORESHEET

A

Contest:	Date:	Category: Intermediate	Programme: Unknown	pilot's number	
----------	-------	----------------------------------	------------------------------	----------------	--

No	Symbol	Catalogue No.	K	Total K	Score	Remarks	Item	K	Score
1		1.38.1 9.1.4.2 9.1.1.1	20 4 6	30			Presentation	8	
2		2.2.4	4	4					
3		1.1.4 9.1.3.6	2 10	12					
4		8.52.3 9.1.3.2	12 4	16					
5		1.2.3 9.9.4.4	7 11	18					
6		5.1.1 9.1.1.1 9.1.5.2	17 6 4	27					
7		8.1.1 9.1.5.1	13 2	15					
8		8.65.1	12	12					
9		7.2.1 9.1.3.4 9.1.3.2	6 8 4	18					
10		7.3.3 9.4.3.2 9.4.3.4	6 5 11	22					

FIGURE TOTAL K = **174**

INCLUDING PRESENTATION = **182**

Aircraft Type:

FREE PROGRAM CHECKED BY:

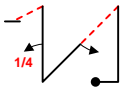
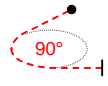
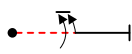
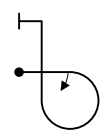
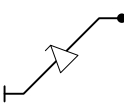
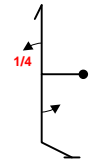
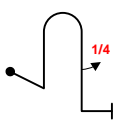
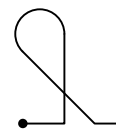
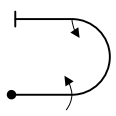
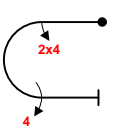
Signature:	Date:
	IAC No.

Judge
Name
Number



pilot



B	Contest:	Category: Intermediate
Date:	Program: Unknown	Pilot's No. <input type="text"/>

wind direction

Pilot:

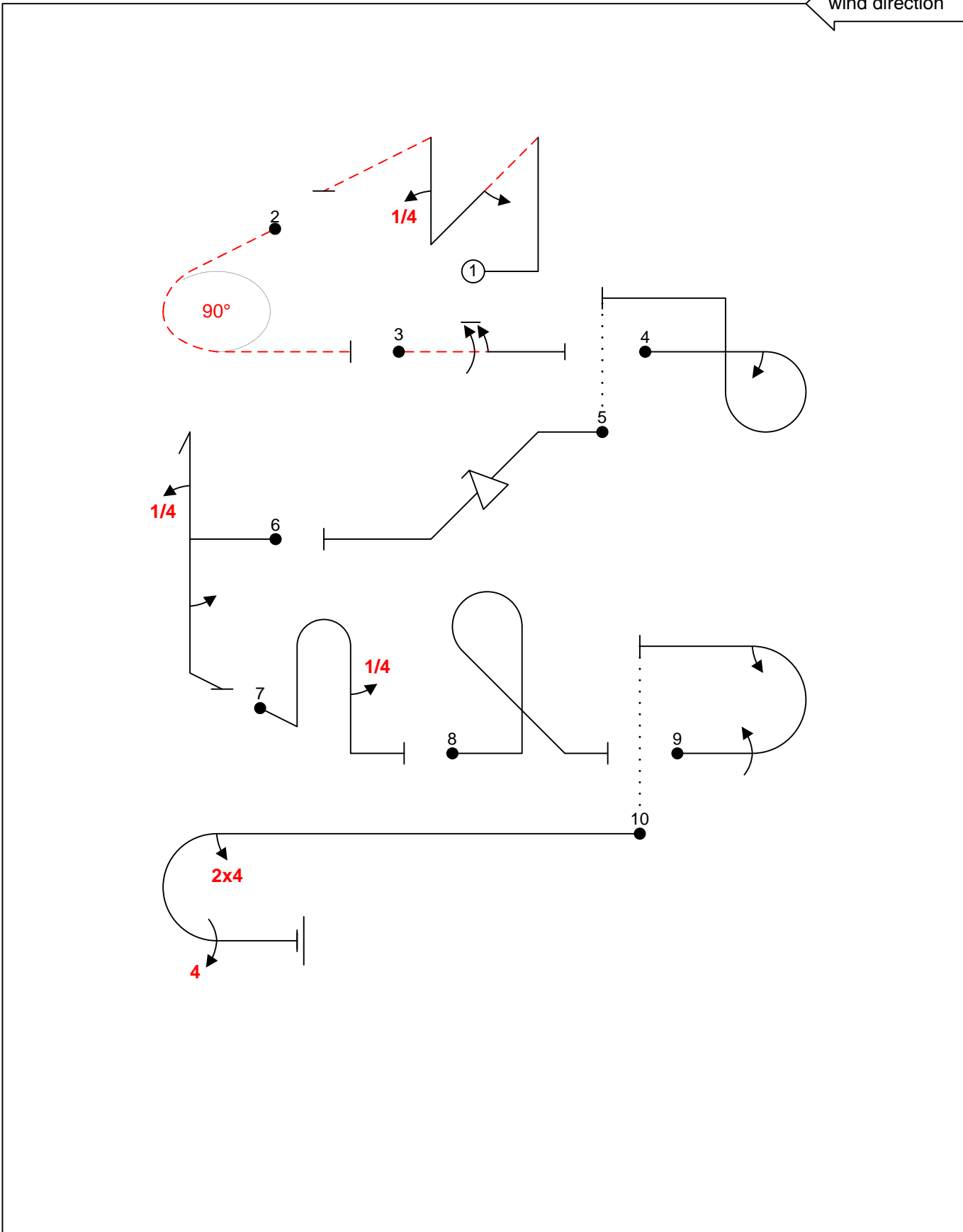

A/C:

(signature/date)

FREE PROGRAM CHECK BY:



C	Contest:	Category: Intermediate
Date:	Program: Unknown	Pilot's No. <input type="text"/>

wind direction

Pilot: _____

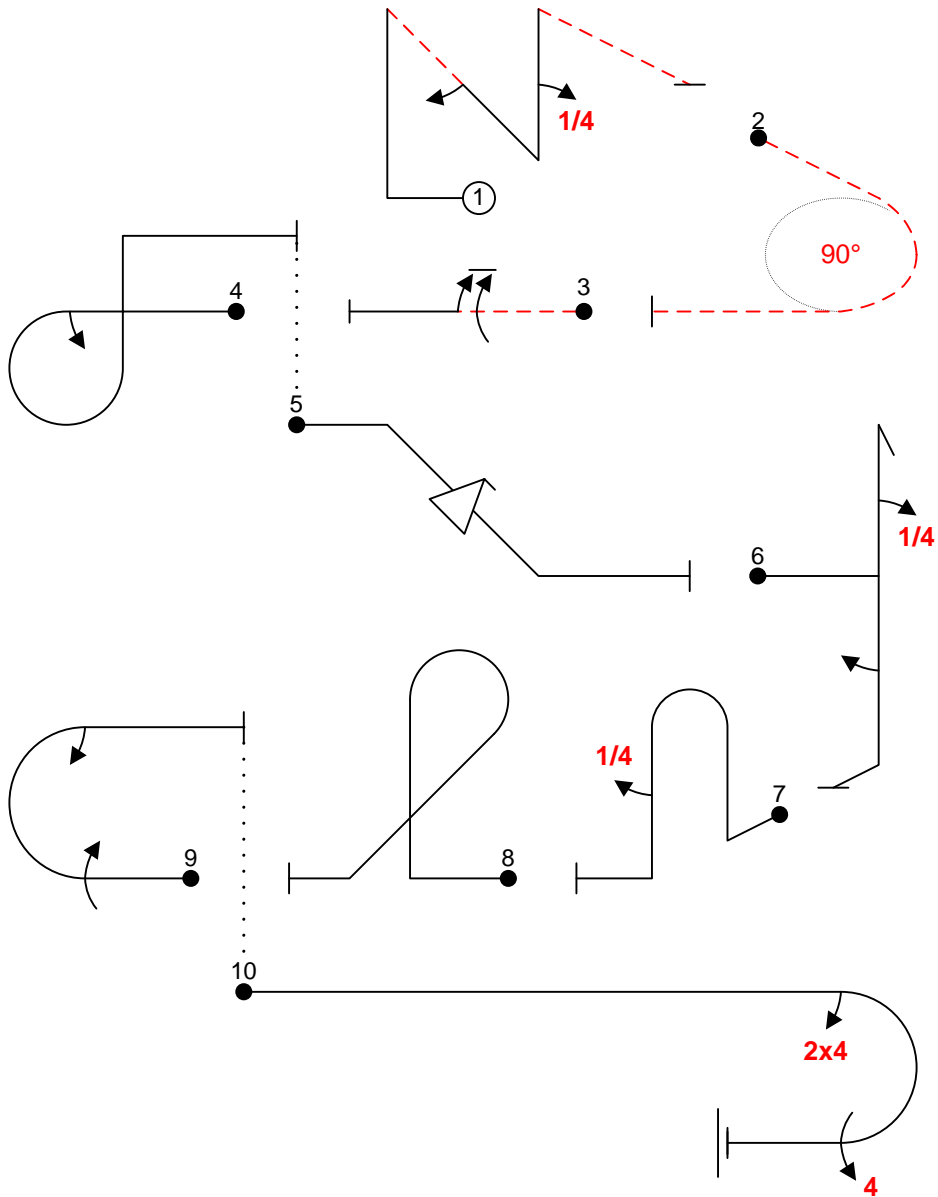

A/C: _____

(signature/date)

FREE PROGRAM CHECK BY: _____