

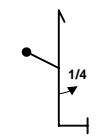

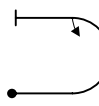
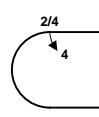
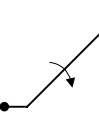
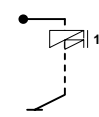

INTERNATIONAL AEROBATIC CLUB SCORESHEET

A	Contest:	Date:	Category: Intermediate	Programme: Unknown	pilot's number	

No	Symbol	Catalogue No.	K	Total K	Grade	Remarks	Item	K	Grade
1		5.1.1 9.1.5.1	17 2	19			Presentation	8	
2		7.2.1 9.1.3.2	6 4	10			FIGURE TOTAL K =	170	
3		7.3.3 9.4.3.2	6 5	11			INCLUDING PRESENTATION =	178	
4		1.2.1 9.1.2.4	7 10	17			Aircraft Type:		
5		1.6.3 9.11.1.5	10 4	14					
6		2.1.3	5	5					
7		1.18.1 9.4.4.2	13 5	18					
8		8.1.1 9.1.1.1	13 6	19					
9		5.1.1	17	17					
10		8.3.1 9.1.5.1	15 2	17					
11		1.6.1	10	10					
12		1.1.1 9.9.3.4	2 11	13					

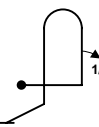
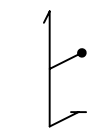
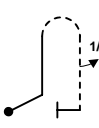
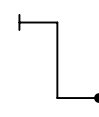
FREE PROGRAM CHECKED BY:

Signature:	Date:
	IAC No.

Judge
Name
Number



pilot



B	Contest:	Category: Intermediate
Date:	Program: Unknown	Pilot's No.

wind direction

Pilot:

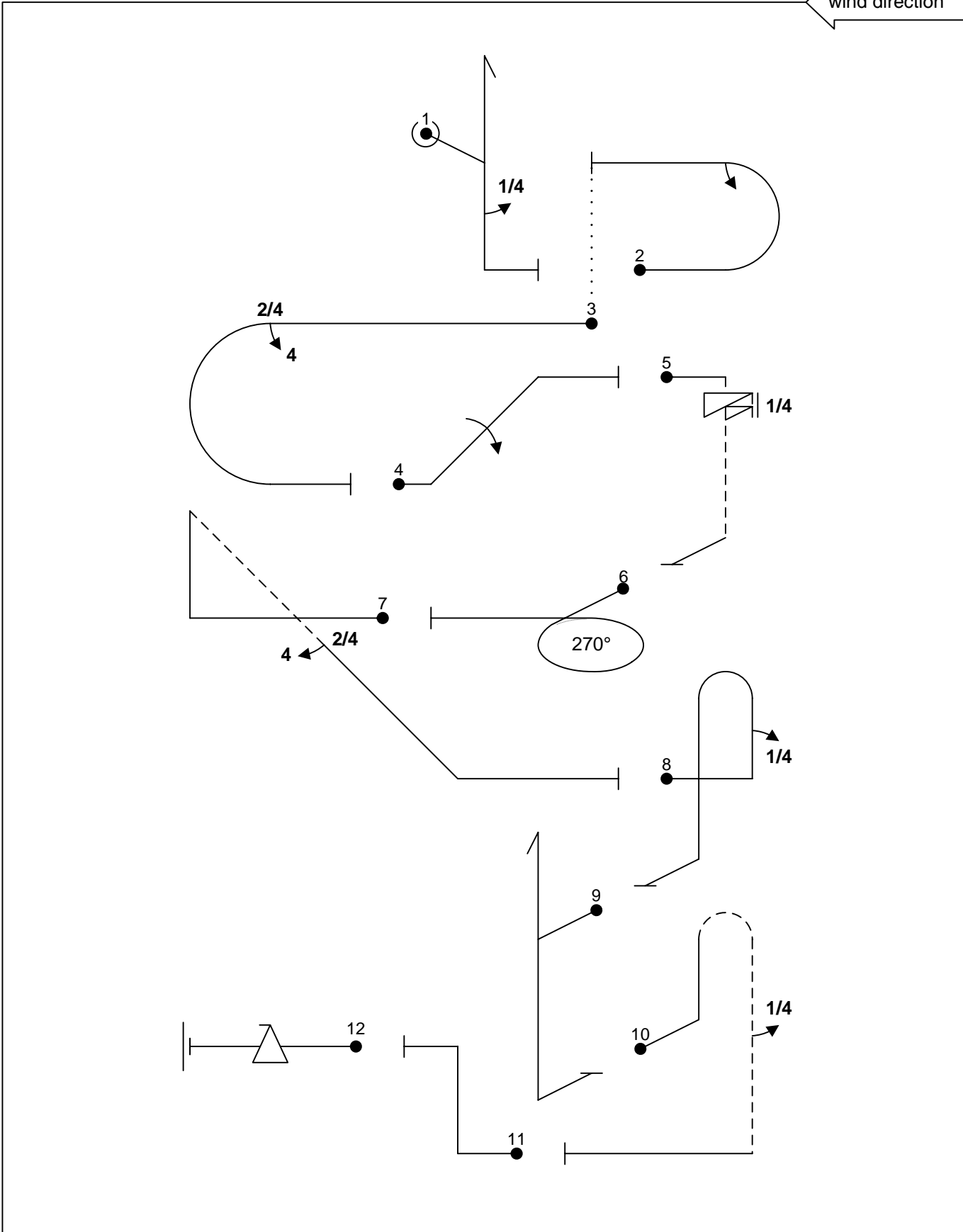

A/C:

(signature/date)

FREE PROGRAM CHECK BY:



C	Contest:	Category: Intermediate
Date:	Program: Unknown	Pilot's No. <input type="text"/>

wind direction

Pilot: _____

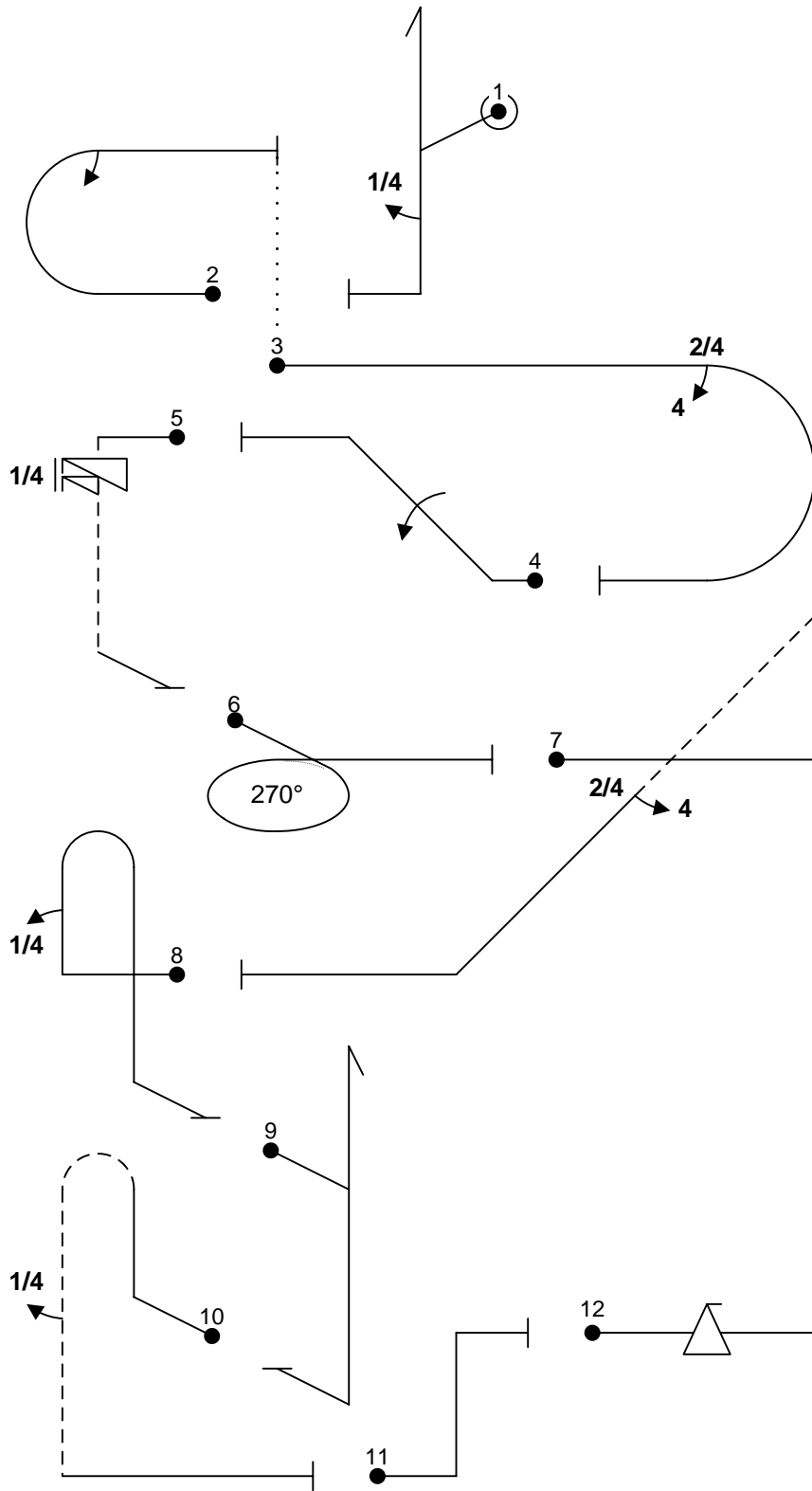

A/C: _____

(signature/date)

FREE PROGRAM CHECK BY: _____