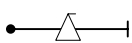
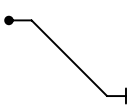
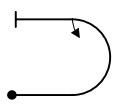
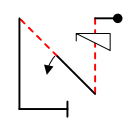
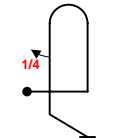
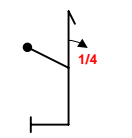
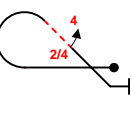
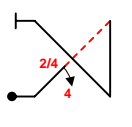
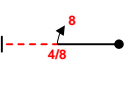

INTERNATIONAL AEROBATIC CLUB SCORESHEET

A

Contest:	Date:	Category: Intermediate	Programme: Unknown	pilot's number	
----------	-------	----------------------------------	------------------------------	----------------	--

No	Symbol	Catalogue No.	K	Total K	Score	Remarks
1		1.1.1 9.9.3.4	2 11	13		
2		1.2.3	7	7		
3		7.2.1 9.1.3.2	6 4	10		
4		1.43.3 9.11.1.4 9.1.2.2	21 5 6	32		
5		8.1.1 9.1.5.1	13 2	15		
6		5.1.1 9.1.1.1	17 6	23		
7		8.42.1 9.4.4.2	10 5	15		
8		1.29.1 9.4.2.2	18 7	25		
9		1.1.3 9.8.3.2	2 7	9		

Item	K	Score
Presentation	8	

FIGURE TOTAL K = 149

INCLUDING PRESENTATION = 157

Aircraft Type:

FREE PROGRAM CHECKED BY:

Signature:	Date:
	IAC No.

Judge
Name
Number



pilot



B	Contest:	Category: Intermediate
Date:	Program: Unknown	Pilot's No. <input type="text"/>

wind direction

Pilot:

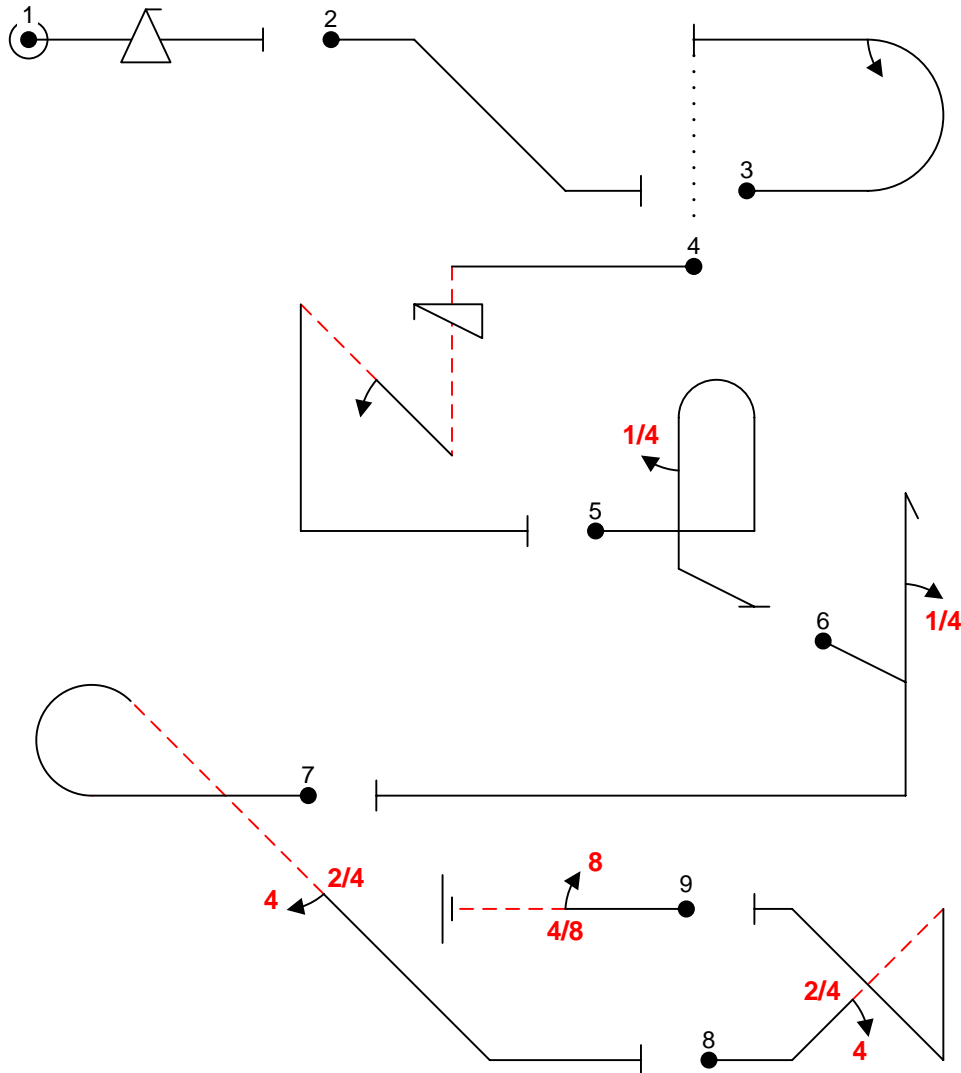

A/C:

(signature/date)

FREE PROGRAM CHECK BY:



C	Contest:	Category: Intermediate
Date:	Program: Unknown	Pilot's No. <input type="text"/>

Pilot: _____

wind direction

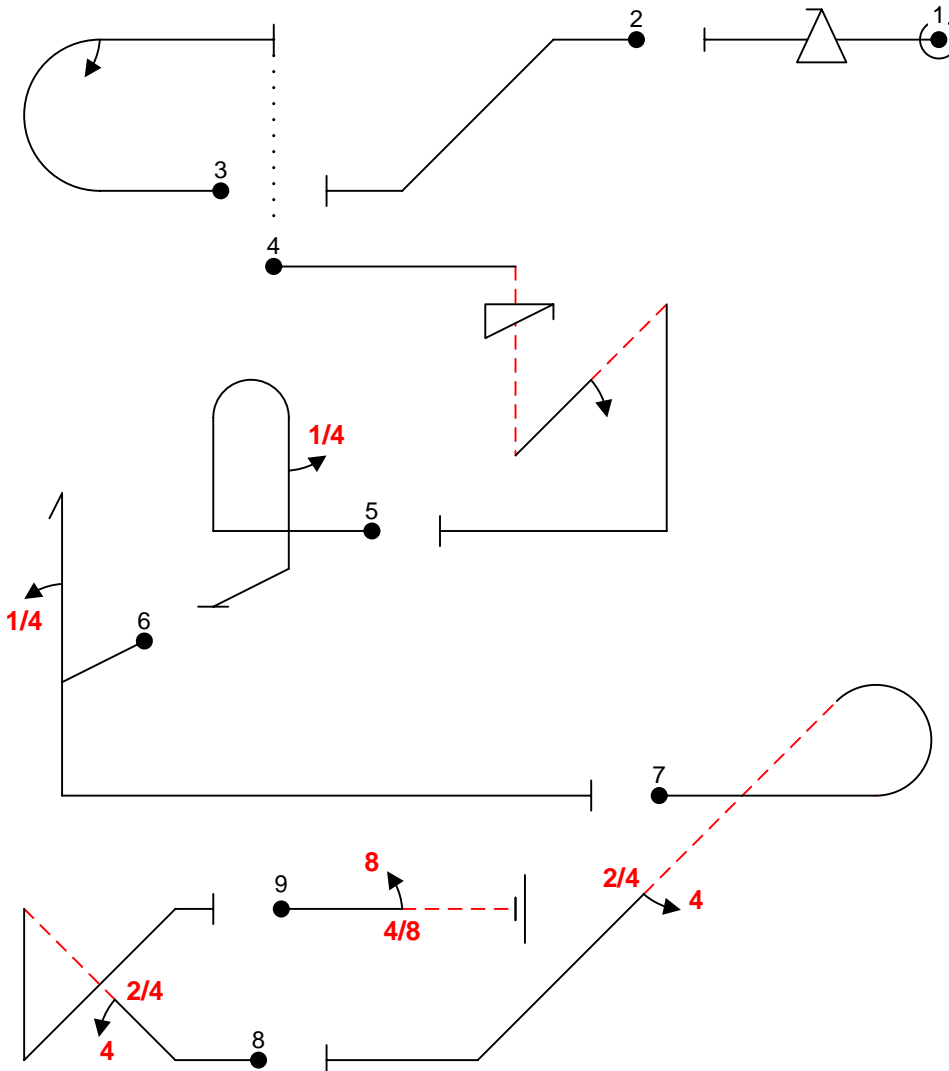

A/C: _____

FREE PROGRAM CHECK BY: (signature/date) _____