

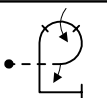

A	INTERNATIONAL AEROBATIC CLUB SCORESHEET				Contest:			Date:		Category		Programme		pilot's number	
										Intermediate		Unknown			
No	Symbol	Catalog No	K	Tot. K	Score	Remarks	No	Symbol	Catalog No	K	Tot. K	Score	Remarks		
1		8.51.2 9.1.3.2 9.1.3.4	12 4 8	24			13								
2		1.2.1 9.1.2.4	7 10	17			14								
3		1.6.3 9.11.1.6	10 3	13			15								
4		7.20.1 9.4.2.2	14 7	21			16								
5		1.2.3 9.9.4.4	7 11	18			17								
6		5.1.1 9.1.5.1	17 2	19			18								
7		8.3.1 9.1.1.1	15 6	21			POSITIONING				8				
8		8.33.1	11	11			FIGURE TOTAL K =				144				
9							INCLUDING POSITIONING =				152				
10							JUDGE'S NAME								
11							JUDGE'S NUMBER								
12							FREE PROGRAM CHECKED BY:								
							AIRCRAFT TYPE								

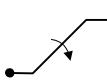

pilot's name  
(print)

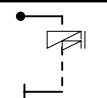
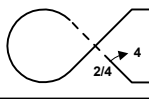

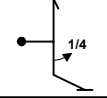
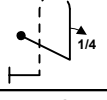
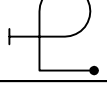
<b>B</b>	Contest:		Category:	Intermediate	
Date:		Prog:	Unknown	pilot's number	

wind direction

Pilot:

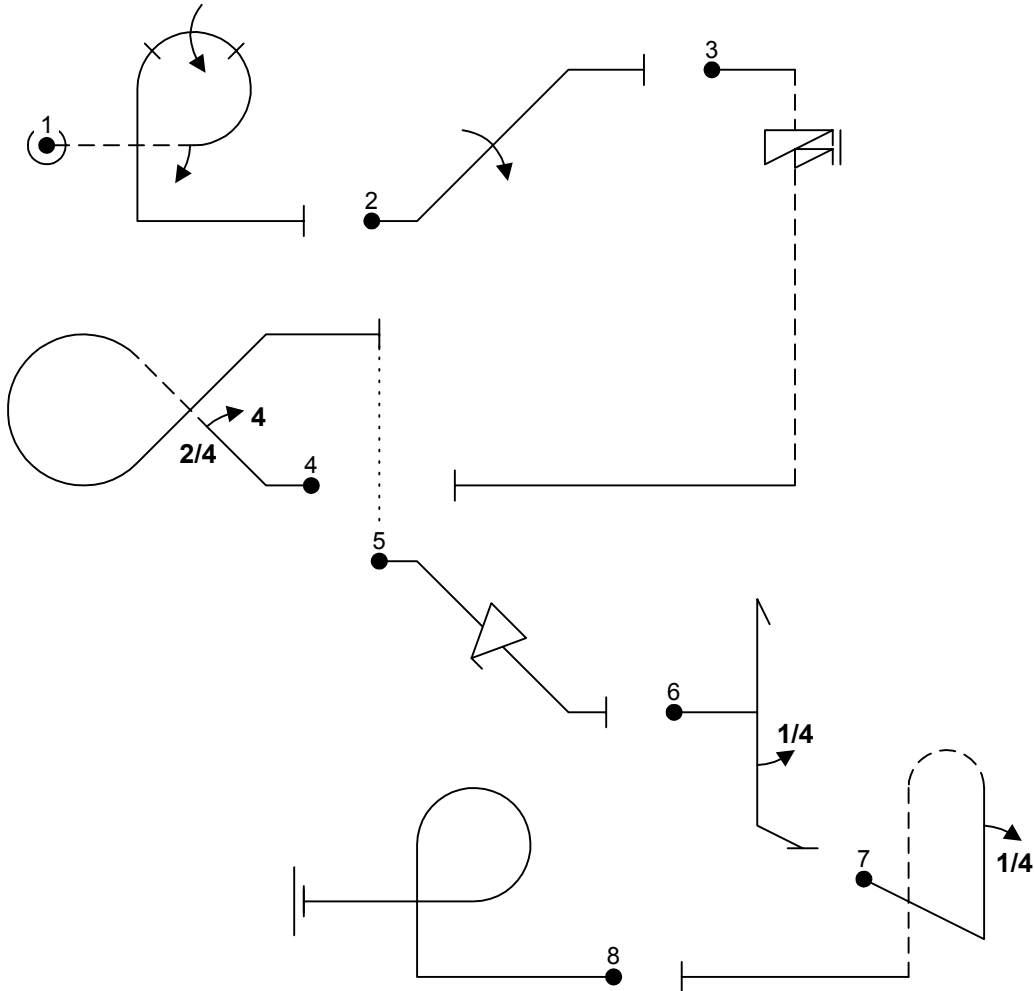

A/C:

(signature/date)

FREE PROGRAM CHECK BY:



<b>C</b>	Contest:		Category:	Intermediate
Date:		Prog:	Unknown	pilot's number

Pilot:

wind direction

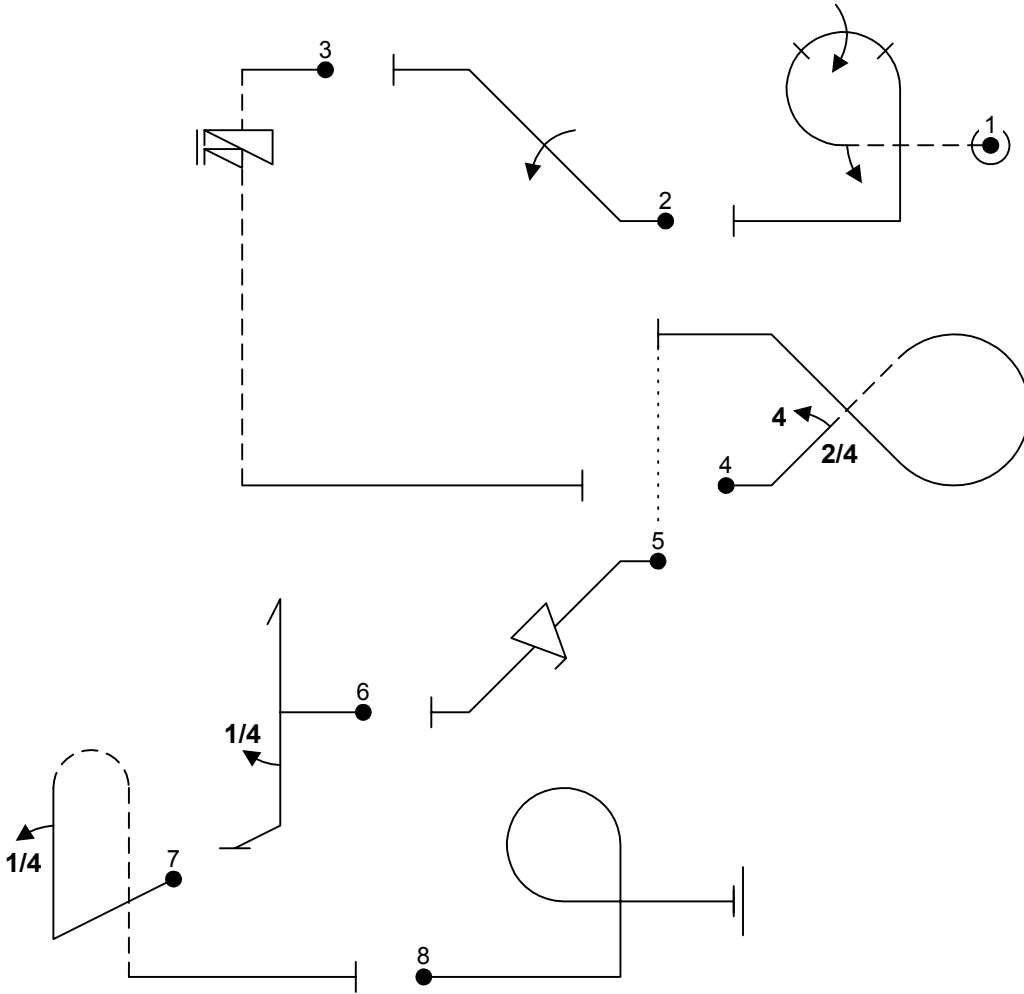

A/C:

(signature/date)

FREE PROGRAM CHECK BY: