

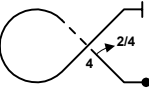

INTERNATIONAL AEROBATIC CLUB SCORESHEET					Contest:			Date:		Category		Programme		pilot's number
A										Intermediate		Unknown		
No	Symbol	Catalog No	K	Tot. K	Score	Remarks	No	Symbol	Catalog No	K	Tot. K	Score	Remarks	
1		8.1.1	13	13			13							
2		7.20.1 9.4.2.2	14 7	21			14							
3		1.6.3 9.11.1.4	10 5	15			15							
4		1.7.1 9.1.1.1	9 6	15			16							
5		1.7.4 9.1.5.1	9 2	11			17							
6		1.1.1 9.2.3.4	2 9	11			18							
7		7.4.3 9.1.3.2 9.1.3.2	6 4 4	14			POSITIONING					8		
8		1.1.4 9.4.3.2	2 5	7			FIGURE TOTAL K =					146		
9		1.18.1 9.4.4.2	13 5	18			INCLUDING POSITIONING =					154		
10		7.5.1 9.9.3.4	10 11	21			JUDGE'S NAME _____							
11							JUDGE'S NUMBER _____							
12							FREE PROGRAM CHECKED BY: _____							
							AIRCRAFT TYPE _____							

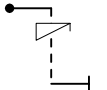

pilot's name
(print)

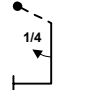
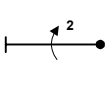
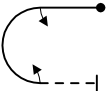
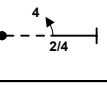
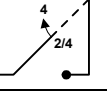
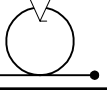

B	Contest:		Category:	Intermediate	
Date:		Prog:	Unknown	pilot's number	

wind direction

NOTE DOWNWIND START

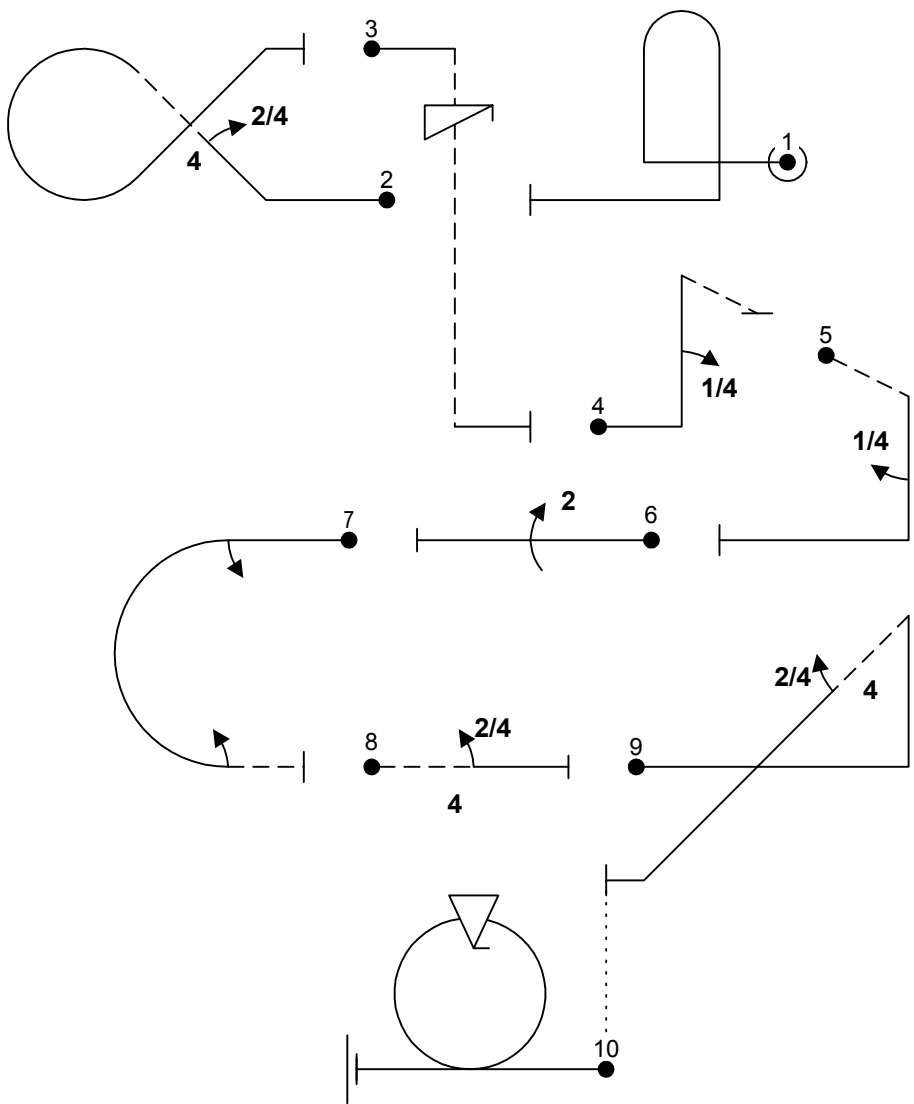

A/C:

(signature/date)

FREE PROGRAM CHECK BY:



C	Contest:		Category:	Intermediate
Date:		Prog:	Unknown	pilot's number

Pilot:

wind direction

NOTE DOWNWIND START

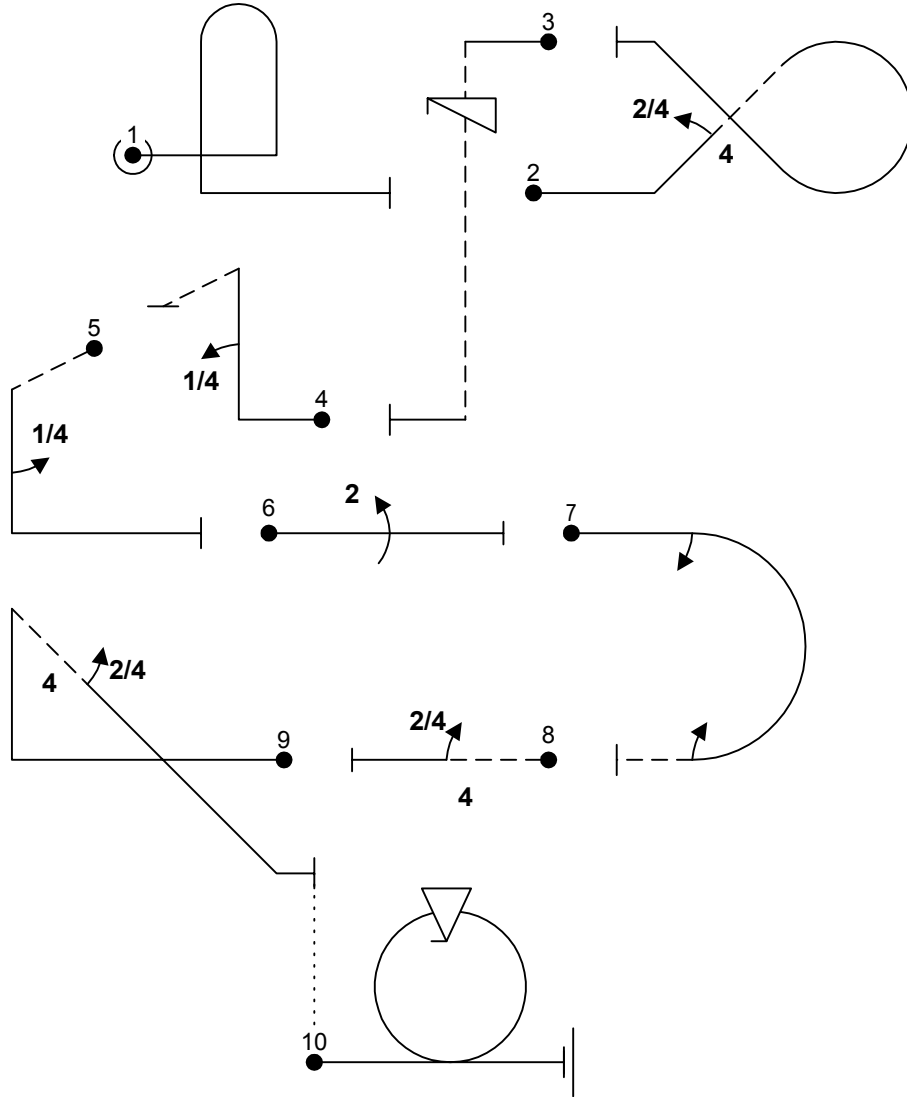

A/C:

(signature/date)

FREE PROGRAM CHECK BY: