

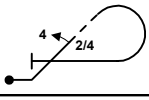

A	INTERNATIONAL AEROBATIC CLUB SCORESHEET				Contest:			Date:		Category		Programme		pilot's number	
										Intermediate		Unknown			
No	Symbol	Catalog No	K	Tot. K	Score	Remarks	No	Symbol	Catalog No	K	Tot. K	Score	Remarks		
1		5.1.1 9.1.5.1	17 2	19			13								
2		8.32.1 9.4.2.2	10 7	17			14								
3		7.26.1 9.4.4.2 9.1.4.2	19 5 4	28			15								
4		8.1.1 9.1.5.1	13 2	15			16								
5		2.2.3	3	3			17								
6		1.1.3 9.4.3.2	2 5	7			18								
7		1.1.4 9.1.3.2	2 4	6			POSITIONING				8				
8		7.3.3 9.4.3.2 9.2.3.4	6 5 9	20			FIGURE TOTAL K =				148				
9		7.20.1 9.1.2.2	14 6	20			INCLUDING POSITIONING =				156				
10		1.1.1 9.9.3.4	2 11	13			JUDGE'S NAME								
11							JUDGE'S NUMBER								
12							FREE PROGRAM CHECKED BY:								
							AIRCRAFT TYPE								

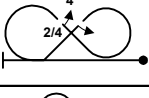

pilot's name  
(print)

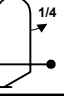

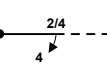
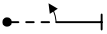
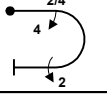
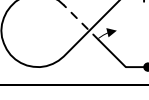
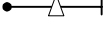
<b>B</b>	Contest:		Category:	Intermediate	
Date:		Prog:	Unknown	pilot's number	

wind direction

NOTE Y-AXIS START

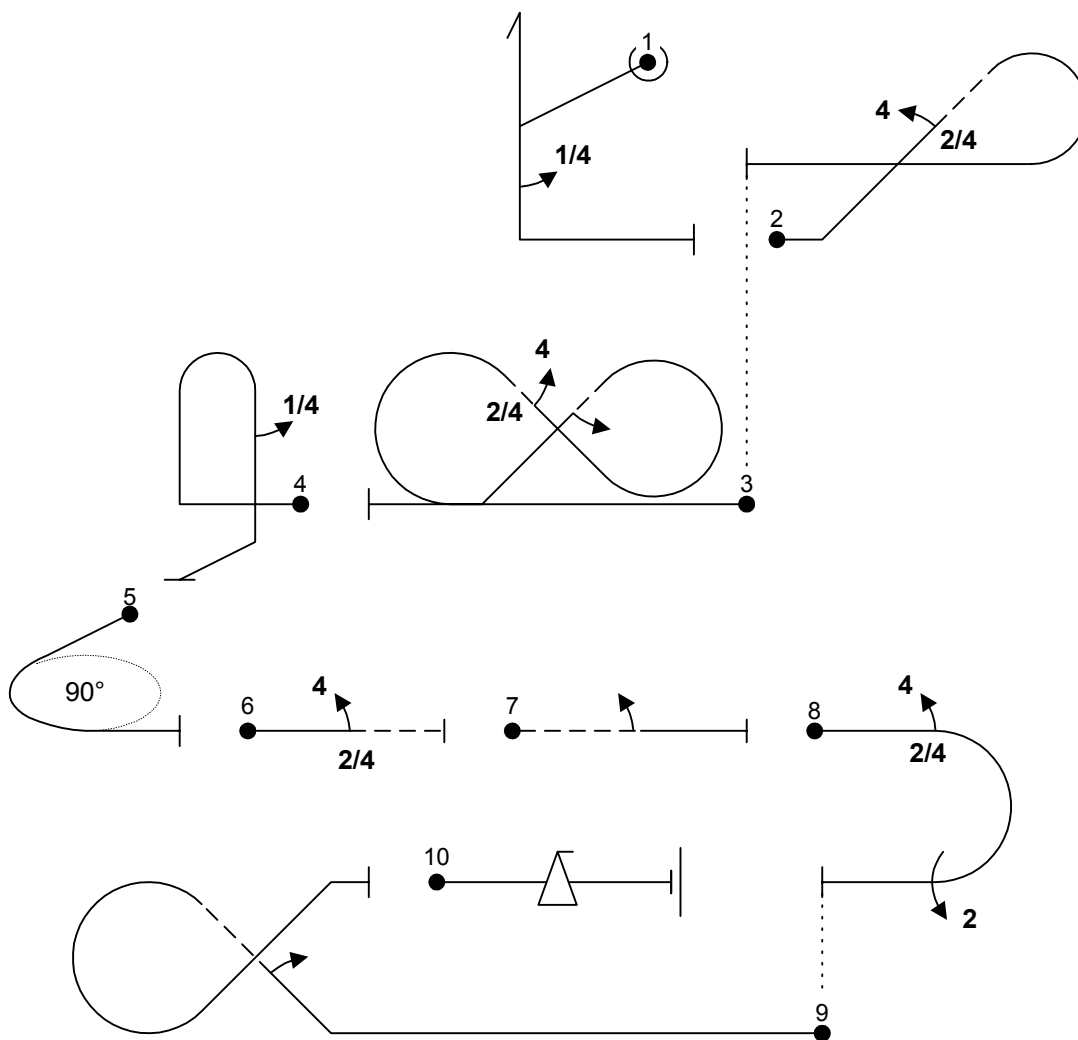

Pilot:

A/C:

(signature/date)

FREE PROGRAM CHECK BY:



<b>C</b>	Contest:		Category:	Intermediate	
Date:		Prog:	Unknown	pilot's number	

wind direction

NOTE Y-AXIS START

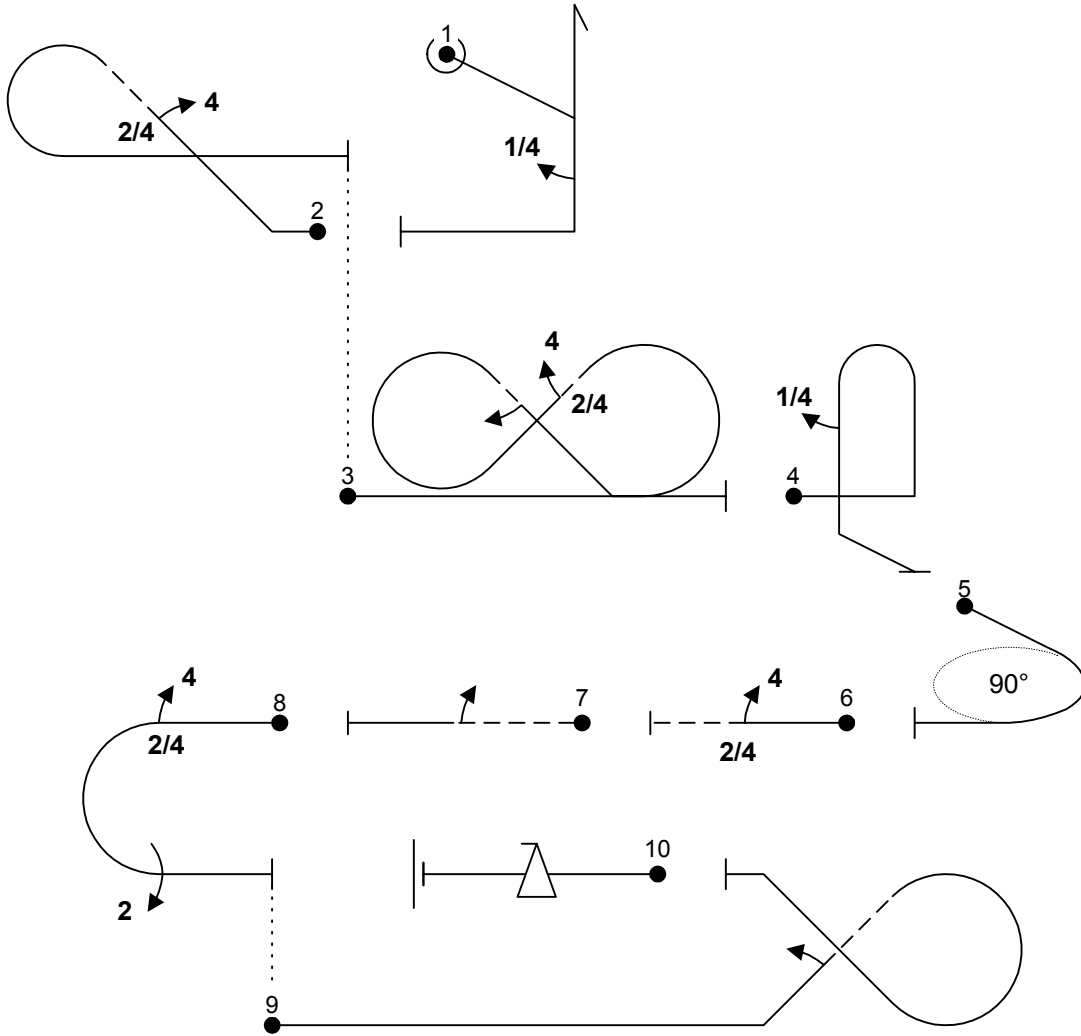

Pilot:

A/C:

(signature/date)

FREE PROGRAM CHECK BY: