











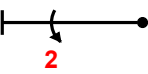

INTERNATIONAL AEROBATIC CLUB SCORESHEET

A

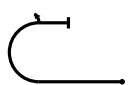
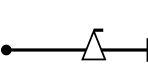
| | | | | | |
|----------|-------|------------------------------------|--------------------|-------------------|--|
| Contest: | Date: | Category: Power Intermediate | Programme: Free | pilot's number | |
|----------|-------|------------------------------------|--------------------|-------------------|--|

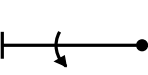
| No | Symbol | Cat. No. | K | Total K | Grade | Remarks | Item | K | Score | | | | | | |
|--|---|---------------------|---------|-------------------|-------|---------|---|--|---------------|-------|---------|--|--|--|--|
| 1 |  | 1.1.3.1 9.1.2.2 | 7 6 | 13 SF 7 | | | <div style="border: 1px solid black; padding: 5px; margin-bottom: 5px;">Presentation 20</div> <div style="border: 1px solid black; padding: 5px; margin-bottom: 5px;">FIGURE TOTAL K = 190</div> <div style="border: 1px solid black; padding: 5px; margin-bottom: 5px;">INC. PRESENTATION = 210</div> <div style="border: 1px solid black; padding: 5px; margin-bottom: 5px;">Aircraft type: E300L</div> <div style="border: 1px solid black; padding: 5px; margin-bottom: 5px;"> <table style="width: 100%; border-collapse: collapse;"> <tr> <td style="width: 33%; border-right: 1px solid black; padding: 5px;">FREE PROGRAM CHECKED BY: Signature:</td> <td style="width: 33%; border-right: 1px solid black; padding: 5px;">Printed Name:</td> <td style="width: 33%; padding: 5px;">Date:</td> </tr> <tr> <td style="border-right: 1px solid black; padding: 5px;">IAC No:</td> <td colspan="2" style="padding: 5px;"></td> </tr> </table> </div> <div style="border: 1px solid black; padding: 5px; margin-bottom: 5px;">Judge Name:</div> <div style="border: 1px solid black; padding: 5px; margin-bottom: 5px;">IAC #</div> <div style="border: 1px solid black; padding: 5px; margin-bottom: 5px;">Assistant Name:</div> <div style="border: 1px solid black; padding: 5px; margin-bottom: 5px;">IAC #</div> <div style="text-align: center; margin-bottom: 5px;">  </div> <div style="text-align: right; margin-bottom: 5px;"> <i>John Shavinsky</i> Pilot N64AL </div> | FREE PROGRAM CHECKED BY: Signature: | Printed Name: | Date: | IAC No: | | | | |
| FREE PROGRAM CHECKED BY: Signature: | Printed Name: | Date: | | | | | | | | | | | | | |
| IAC No: | | | | | | | | | | | | | | | |
| 2 |  | 1.1.7.4 | 9 | 9 SF 7 | | | | | | | | | | | |
| 3 |  | 1.1.1.1 9.2.3.4 | 2 9 | 11 SF 7 | | | | | | | | | | | |
| 4 |  | 1.2.7.1 9.1.4.2 | 13 4 | 17 SF 7 | | | | | | | | | | | |
| 5 |  | 8.4.3.1 | 15 | 15 SF 7 | | | | | | | | | | | |
| 6 |  | 5.2.1.1 | 17 | 17 SF 5 | | | | | | | | | | | |
| 7 |  | 8.5.2.1 9.4.2.2 | 10 7 | 17 SF 7 | | | | | | | | | | | |
| 8 |  | 1.1.6.1 | 10 | 10 SF 7 | | | | | | | | | | | |
| 9 |  | 1.1.6.3 9.11.1.6 | 10 3 | 13 SF 3 | | | | | | | | | | | |
| 10 |  | 7.2.2.1 9.1.3.2 | 6 4 | 10 SF 7 | | | | | | | | | | | |
| 11 |  | 1.1.1.1 9.9.3.4 | 2 11 | 13 SF 4 | | | | | | | | | | | |
| 12 |  | 7.2.3.3 9.4.3.2 | 6 5 | 11 SF 7 | | | | | | | | | | | |
| 13 |  | 1.1.1.1 9.1.3.4 | 2 8 | 10 SF 7 | | | | | | | | | | | |
| 14 |  | 8.5.6.1 9.4.4.2 | 10 5 | 15 SF 7 | | | | | | | | | | | |
| 15 |  | 1.1.7.1 | 9 | 9 SF 7 | | | | | | | | | | | |



| | | |
|----------|----------|---------------|
| B | Contest: | Category: |
| | Date: | Program: Free |

Pilot: John Shevinsky

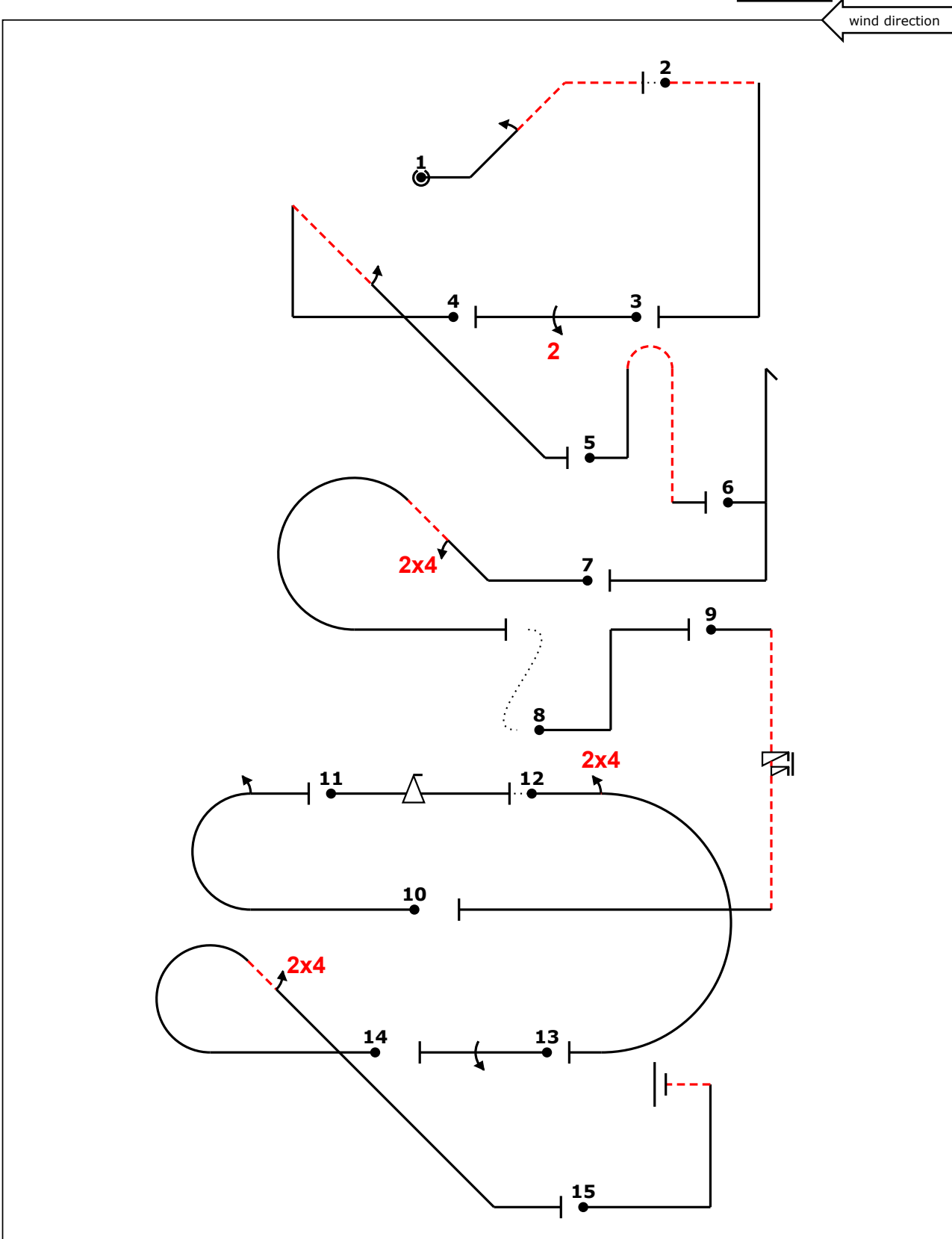

A/C: E300L

(signature/date)

FREE PROGRAM CHECK BY:

d'2'1'-- (-2,0) --iv...'+~ .22+ ~++k''2....'+~ ~~~~pb''+~ ~+.h'+~+~ 7% ~~~~~24'zot~~~~~ (-1,9) --v'+ -iv..'6s..
 ''+++++++ 3% 2> ..'m2 .f+~ (-2,0) 19% ~24at~~~~ ''1- 2> 2% ~c24....''- ~+v.-



| | | |
|----------|----------|---------------|
| C | Contest: | Category: |
| | Date: | Program: Free |

Pilot: John Shevinsky

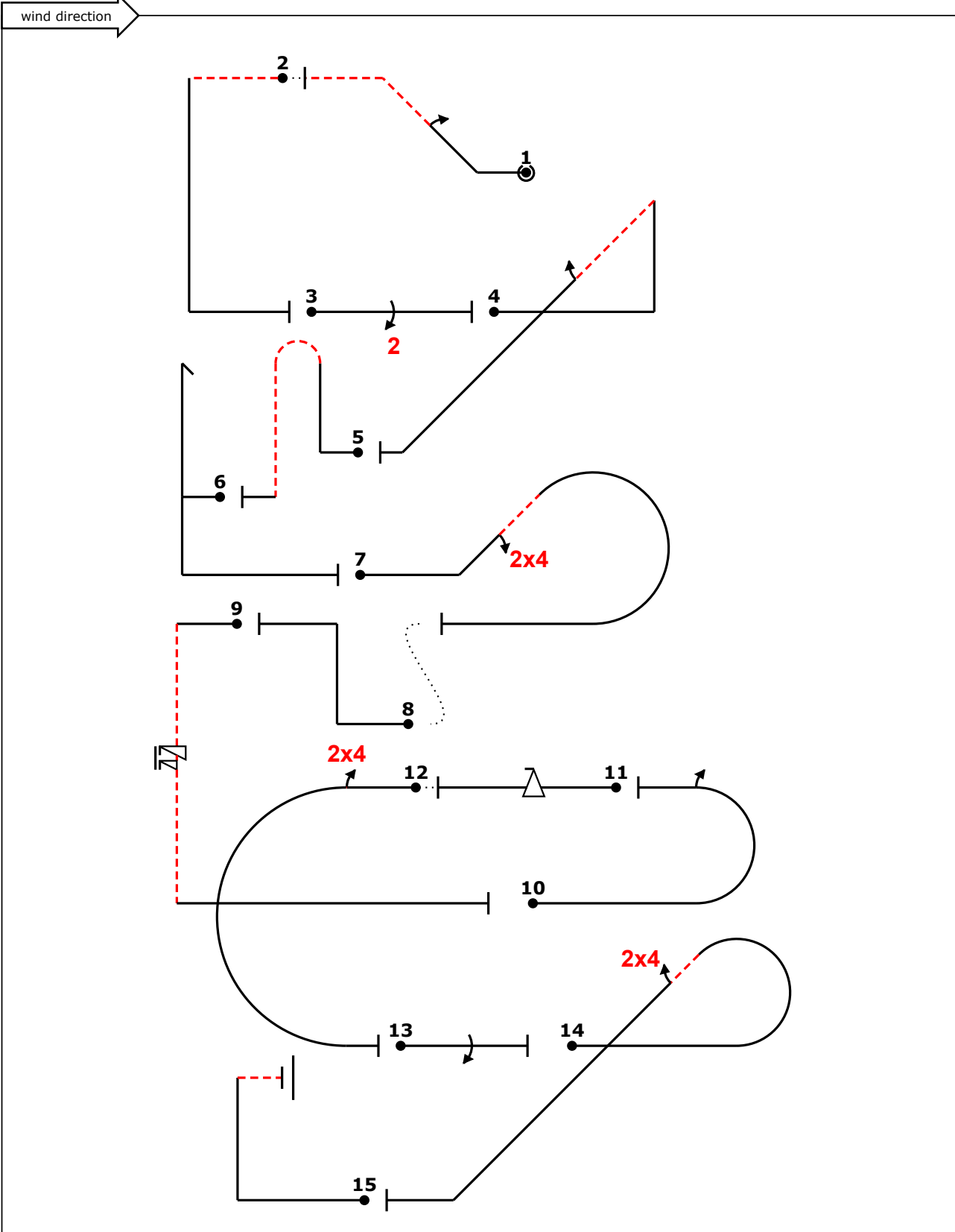

A/C: E300L

(signature/date)

FREE PROGRAM CHECK BY:

d'2'1'-- (-2,0) --iv...'+-- .22+ ~++k'2...'+~ ~~~~pb'+'~ ~+.h'++- 7% ~~~~~24'zot~~~~~ (-1,9) --v'+ -iv..'6s..
 '+++++++ 3% 2> ..'m2 .f+- (-2,0) 19% ~24at~~~~ '1- 2> 2% ~c24.....' -++v.-