









INTERNATIONAL AEROBATIC CLUB SCORESHEET

A

Contest:	Date: 2024	Category: Power Intermediate	Programme: Free	pilot's number	
----------	---------------	------------------------------------	--------------------	-------------------	--

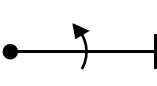
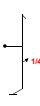
No	Symbol	Cat. No.	K	Total K	Grade	Remarks	Item	K	Score									
1		8.4.1.1	13	13 SF 7			<div style="border: 1px solid black; padding: 5px; margin-bottom: 5px;">Presentation 20</div> <div style="border: 1px solid black; padding: 5px; margin-bottom: 5px;">FIGURE TOTAL K = 190</div> <div style="border: 1px solid black; padding: 5px; margin-bottom: 5px;">INC. PRESENTATION = 210</div> <div style="border: 1px solid black; padding: 5px; margin-bottom: 5px;">Aircraft type: Pitts S-2A</div> <div style="border: 1px solid black; padding: 5px; margin-bottom: 5px;"> <table style="width: 100%; border-collapse: collapse;"> <tr> <td style="width: 33%; border-right: 1px solid black; padding: 5px;">FREE PROGRAM CHECKED BY:</td> <td style="width: 33%; border-right: 1px solid black; padding: 5px;">Signature:</td> <td style="width: 33%; padding: 5px;">Date:</td> </tr> <tr> <td style="border-right: 1px solid black; padding: 5px;"></td> <td style="border-right: 1px solid black; padding: 5px;">Printed Name:</td> <td style="padding: 5px;"></td> </tr> <tr> <td style="border-right: 1px solid black; padding: 5px;"></td> <td style="border-right: 1px solid black; padding: 5px;">IAC No:</td> <td style="padding: 5px;"></td> </tr> </table> </div> <div style="border: 1px solid black; padding: 5px; margin-bottom: 5px;">Judge Name:</div> <div style="border: 1px solid black; padding: 5px; margin-bottom: 5px;">IAC #</div> <div style="border: 1px solid black; padding: 5px; margin-bottom: 5px;">Assistant Name:</div> <div style="border: 1px solid black; padding: 5px;">IAC #</div>	FREE PROGRAM CHECKED BY:	Signature:	Date:		Printed Name:			IAC No:			
FREE PROGRAM CHECKED BY:	Signature:	Date:																
	Printed Name:																	
	IAC No:																	
2		1.1.6.1	10	10 SF 7														
3		1.1.6.3 9.11.1.6	10 3	13 SF 3														
4		1.2.3.1 9.1.2.2	12 6	18 SF 7														
5		1.1.7.1	9	9 SF 7														
6		1.1.7.4	9	9 SF 7														
7		1.1.1.1 9.1.3.4	2 8	10 SF 7														
8		5.2.1.1 9.1.5.1	17 2	19 SF 5														
9		1.2.6.1 9.1.1.1	14 6	20 SF 7														
10		1.2.7.1 9.1.4.2	13 4	17 SF 7														
11		5.3.1.1	18	18 SF 5														
12		1.1.1.1 9.2.3.4	2 9	11 SF 7														
13		7.2.2.1 9.1.3.2	6 4	10 SF 7														
14		1.1.1.1 9.9.3.4	2 11	13 SF 4														

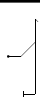
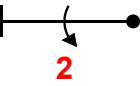
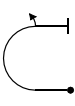
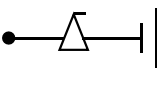

Phillip Gragg Pilot

N5FV A/C



B	Contest:	Category: Power Intermediate
	Date: 2024	Program: Free

Pilot: Philip Gregg

wind direction

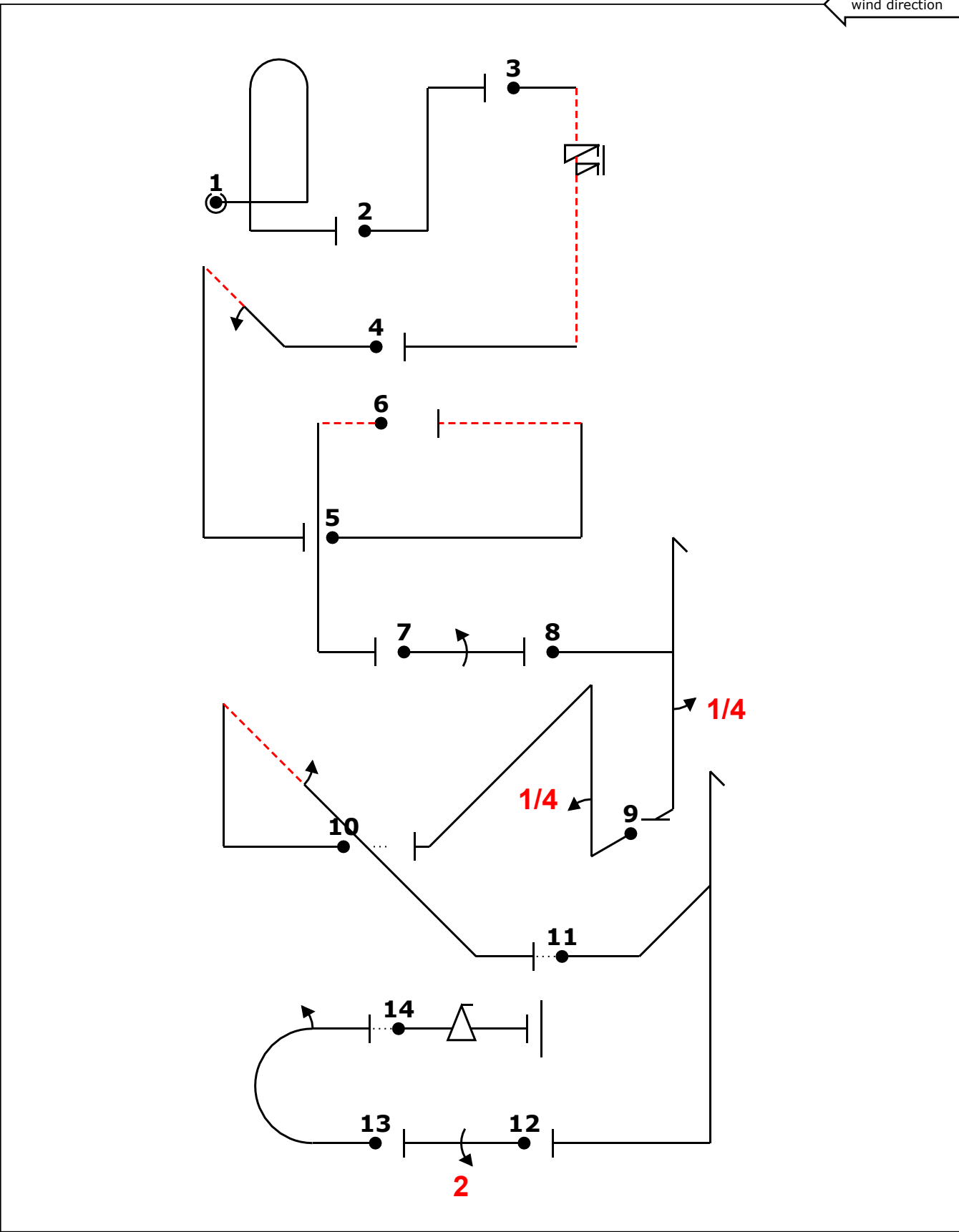

A/C: Pitts S-2A

(signature/date)

FREE PROGRAM CHECK BY:



C	Contest:	Category: Power Intermediate
	Date: 2024	Program: Free

Pilot: Philip Gregg

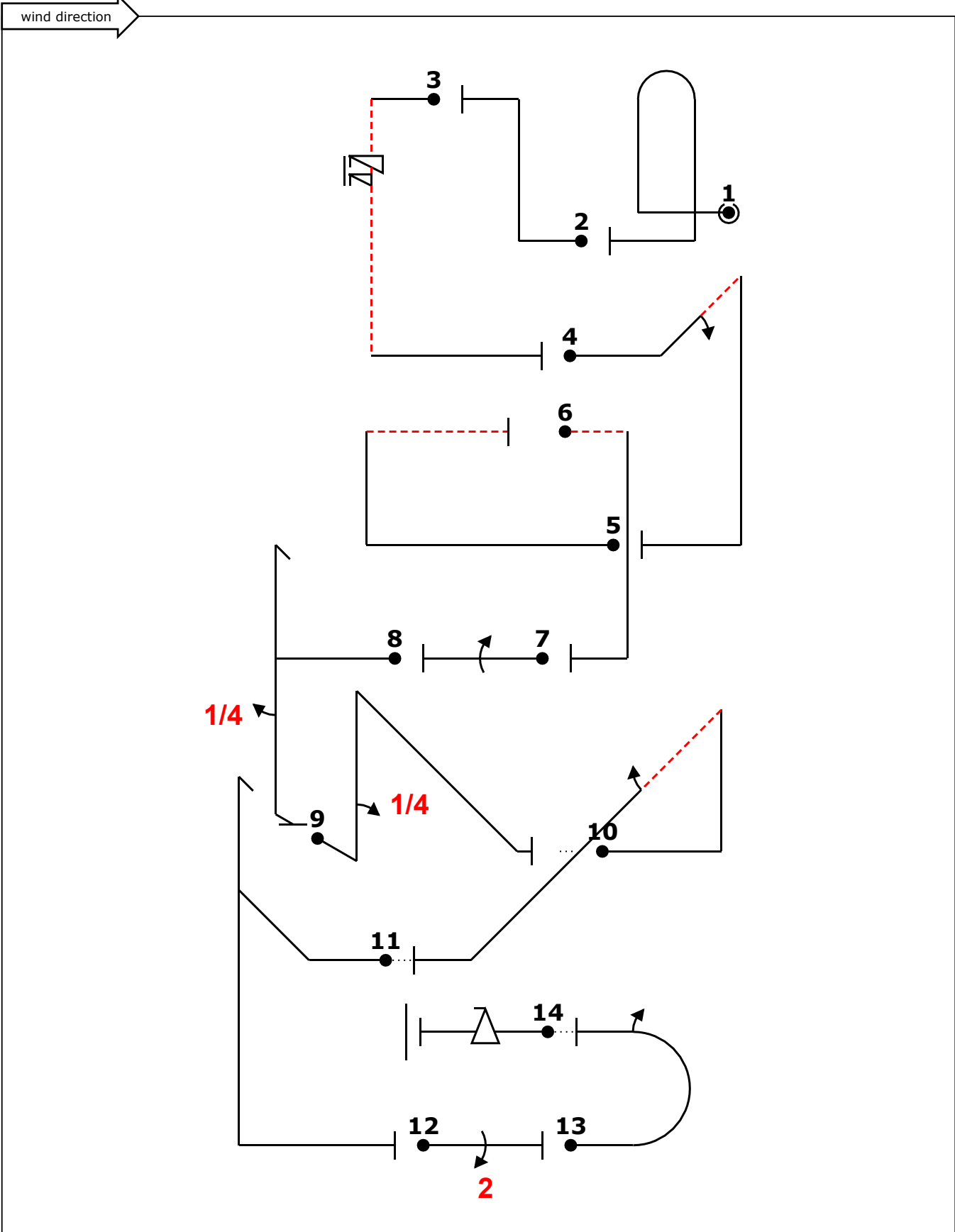

A/C: Pitts S-2A

(signature/date)

FREE PROGRAM CHECK BY: