

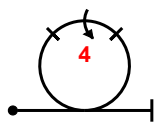





INTERNATIONAL AEROBATIC CLUB SCORESHEET

A

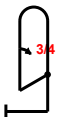
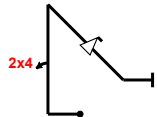
Contest:	Date:	Category: Power Advanced	Programme: Unknown	pilot's number	
----------	-------	--	------------------------------	-------------------	--

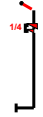
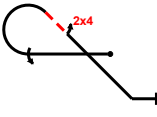
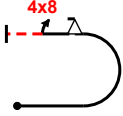
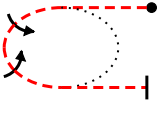
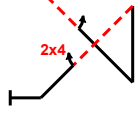
No	Symbol	Cat. No.	K	Total K	Grade	Remarks	Item	K	Score	
1		7.4.1.1 9.4.3.4	10 11	21			Presentation	30		
2		5.2.1.1 9.1.1.2 9.9.5.3	17 8 11	36			FIGURE TOTAL K =		269	
3		8.4.1.1 9.1.1.3	13 10	23			INC. PRESENTATION =		299	
4		1.2.6.1 9.4.1.2 9.9.4.4	14 9 11	34			Aircraft type:			
5		1.1.7.1 9.8.1.1	9 7	16			FREE PROGRAM CHECKED BY: Signature: _____ Printed Name: _____ IAC No: _____ Date: _____			
6		1.1.7.4 9.12.1.5	9 6	15				Judge Name:		
7		8.5.6.1 9.1.3.4 9.4.4.2	10 8 5	23				IAC #		
8		7.2.1.1 9.9.3.2 9.8.3.2	6 11 7	24				Assistant Name:		
9		2.2.5.2	23	23				IAC #		
10		1.3.4.4 9.1.4.2 9.4.4.2	18 4 5	27						
11		8.4.3.1 9.1.1.1 9.1.5.3	15 6 6	27						



_____ Pilot
 _____ A/C



B	Contest:	Category: Power Advanced
	Date:	Program: Unknown
		Pilot's No.

Pilot:

wind direction

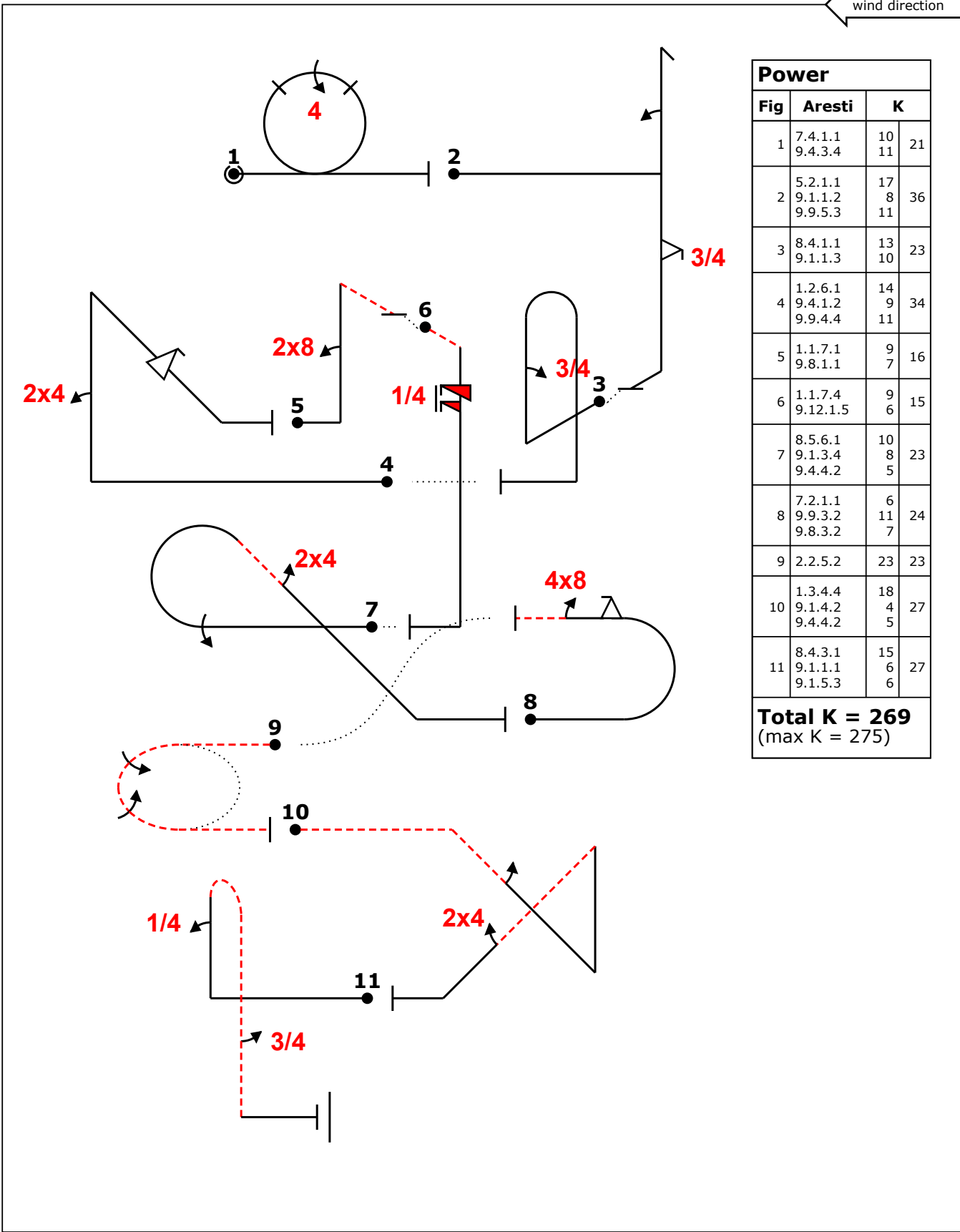

Power			
Fig	Aresti	K	
1	7.4.1.1	10	21
	9.4.3.4	11	
2	5.2.1.1	17	36
	9.1.1.2	8	
	9.9.5.3	11	
3	8.4.1.1	13	23
	9.1.1.3	10	
4	1.2.6.1	14	34
	9.4.1.2	9	
	9.9.4.4	11	
5	1.1.7.1	9	16
	9.8.1.1	7	
6	1.1.7.4	9	15
	9.12.1.5	6	
7	8.5.6.1	10	23
	9.1.3.4	8	
	9.4.4.2	5	
8	7.2.1.1	6	24
	9.9.3.2	11	
	9.8.3.2	7	
9	2.2.5.2	23	23
10	1.3.4.4	18	27
	9.1.4.2	4	
	9.4.4.2	5	
11	8.4.3.1	15	27
	9.1.1.1	6	
	9.1.5.3	6	
Total K = 269 (max K = 275)			

A/C:

(signature/date)

FREE PROGRAM CHECK BY:

o44+ +++'2'h''3f..' (1,-1) +,3'b. (-5,0) ~++++'24.'kf'' /'+v''8'-- (-1,-1) -iv',5is....' (1,0) '1c''24.. + .m',2f';48- (-15,10) 2% -2j2- ~----'2iw(')',24'' ++4pb.'3''



C	Contest:	Category: Power Advanced
	Date:	Program: Unknown
		Pilot's No. <input style="border: 2px solid black;" type="text"/>

Pilot:

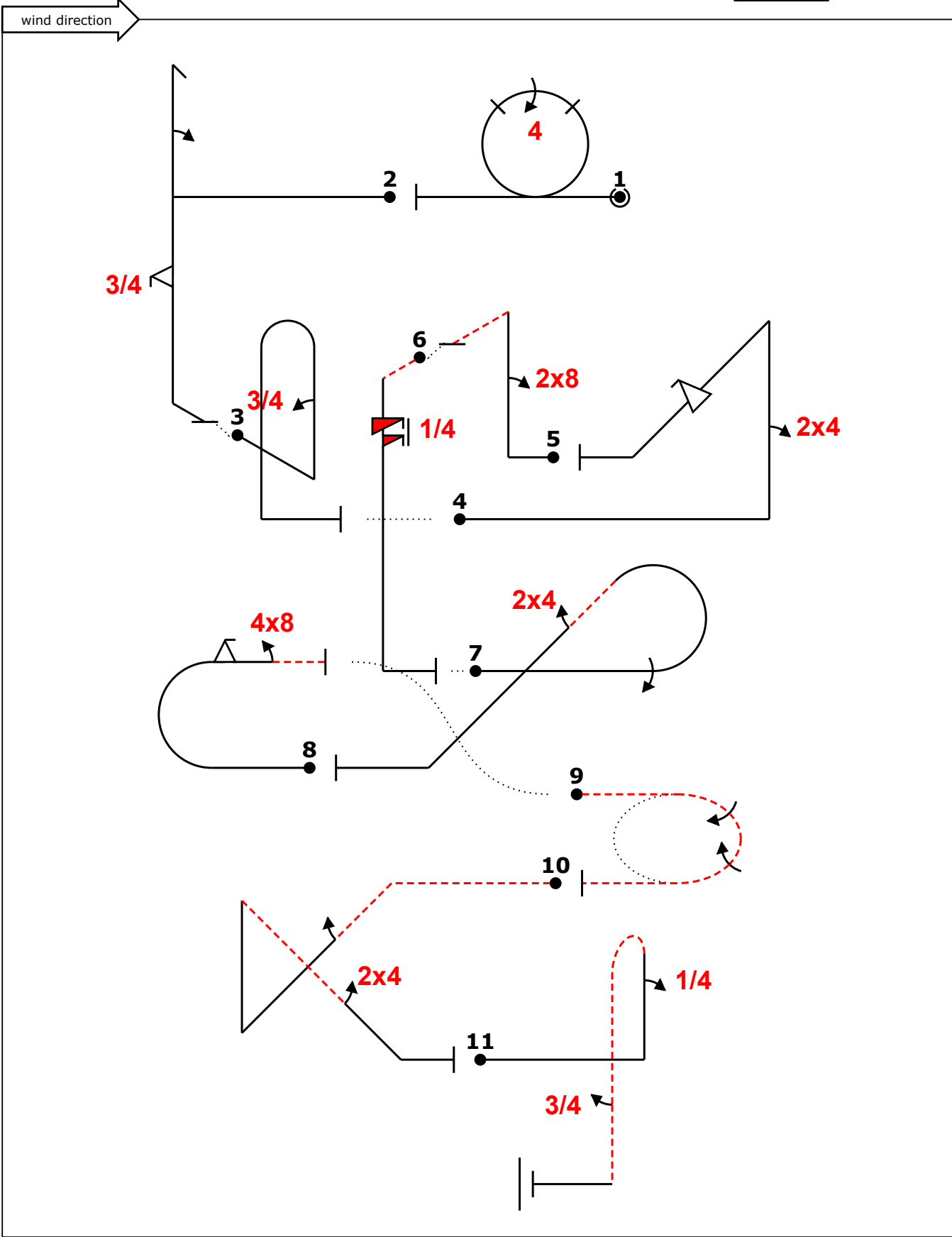

A/C:

(signature/date)

FREE PROGRAM CHECK BY:

o44+ +++'2'h'3f..' (1,-1) +,3'b. (-5,0) ~++++'24.'kf` /'+v'8'-- (-1,-1) -iv',5is....' (1,0) `1c''24..
+ .m',2f';48- (-15,10) 2% -2j2- ~----'2iw(''),24'' ++4pb.'3''



Category: Power Advanced Date: _____
 Program: Unknown

Figure K
269
 Total K
299

Judge Name	IAC#	Pilot #
Asst. Name	IAC#	

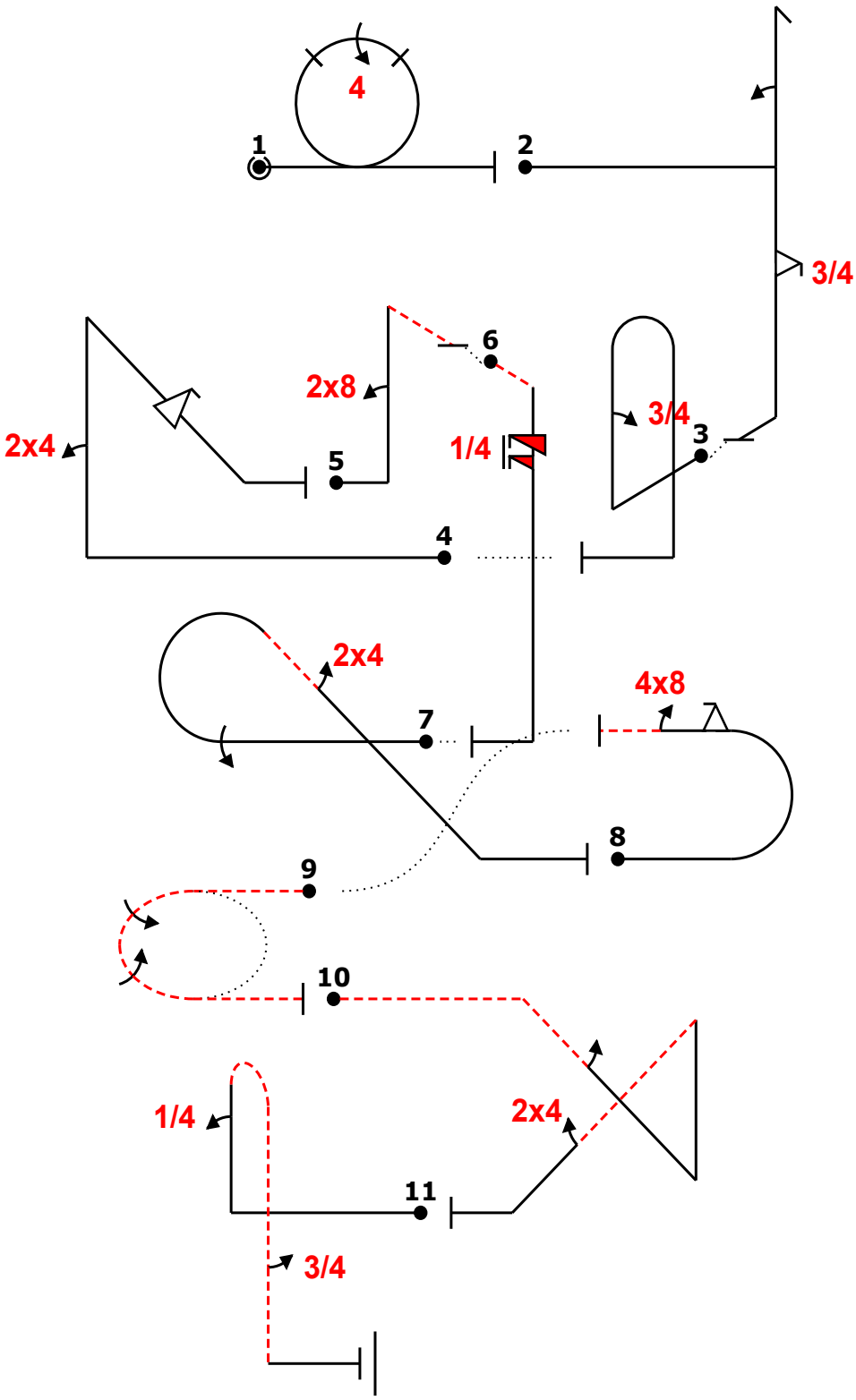
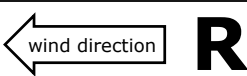

Fig	Grade	Remarks
1	.	
2	.	
3	.	
4	.	
5	.	
6	.	
7	.	
8	.	
9	.	
10	.	
11	.	

Presentation **30**

```
o44+ +++'2'h'3f..' (1,-1) +,3'b. (-5,0) ~+++++'24.'kf' /
`+v'8'-- (-1,-1) -iv',5is.....' (1,0) `1c'24..
+.m',2f';48- (-15,10) 2% -2j2- ~----.'2iw('),,24'' ++4pb.'3''
```

Fig 1	K	Fig 2	K	Fig 3	K	Fig 4	K	Fig 5	K	Fig 6	K	Fig 7	K	Fig 8	K	Fig 9	K	Fig 10	K	Fig 11	K
7.4.1.1	10	5.2.1.1	17	8.4.1.1	13	1.2.6.1	14	1.1.7.1	9	1.1.7.4	9	8.5.6.1	10	7.2.1.1	6	2.2.5.2	23	1.3.4.4	18	8.4.3.1	15
9.4.3.4	11	9.1.1.2	8	9.1.1.3	10	9.4.1.2	9	9.8.1.1	7	9.12.1.5	6	9.1.3.4	8	9.9.3.2	11			9.1.4.2	4	9.1.1.1	6
		9.9.5.3	11			9.9.4.4	11					9.4.4.2	5	9.8.3.2	7			9.4.4.2	5	9.1.5.3	6
	21		36		23		34		16		15		23		24		23		27		27



Category: Power Advanced Date: _____
 Program: Unknown

Figure K
269
 Total K
299

Judge Name	IAC#	Pilot #
Asst. Name	IAC#	

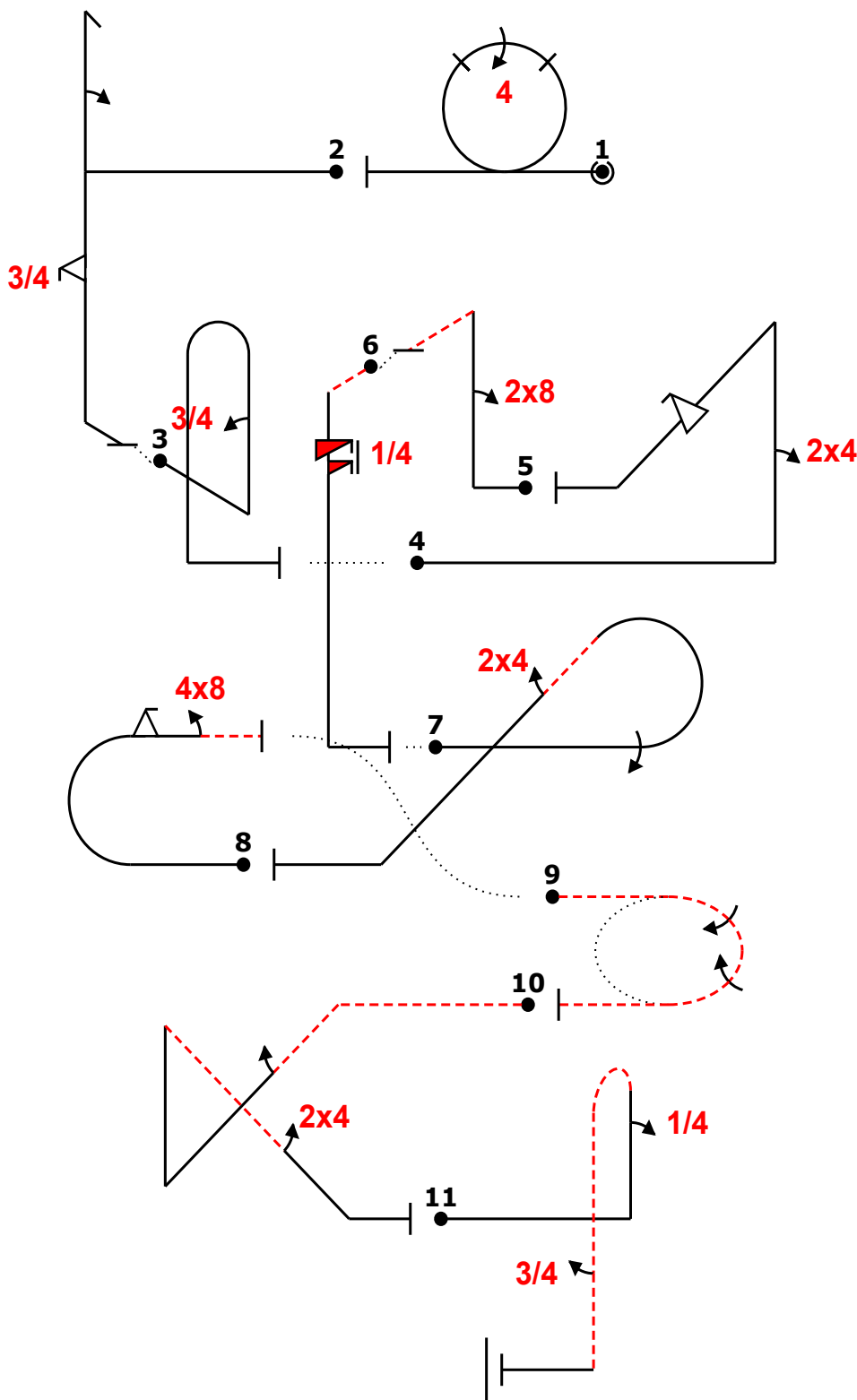
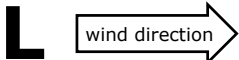

Fig	Grade	Remarks
1	.	
2	.	
3	.	
4	.	
5	.	
6	.	
7	.	
8	.	
9	.	
10	.	
11	.	

Presentation **30**

o44+ +++'2'h'3f..' (1,-1) +,3'b. (-5,0) ~++++'24.'kf' /
 `+v'8'-- (-1,-1) -iv'5is.....' (1,0) `1c'24..
 +.m',2f';48- (-15,10) 2% -2j2- ~----.'2iw('),,24'' ++4pb.'3''

Fig 1	K	Fig 2	K	Fig 3	K	Fig 4	K	Fig 5	K	Fig 6	K	Fig 7	K	Fig 8	K	Fig 9	K	Fig 10	K	Fig 11	K
7.4.1.1	10	5.2.1.1	17	8.4.1.1	13	1.2.6.1	14	1.1.7.1	9	1.1.7.4	9	8.5.6.1	10	7.2.1.1	6	2.2.5.2	23	1.3.4.4	18	8.4.3.1	15
9.4.3.4	11	9.1.1.2	8	9.1.1.3	10	9.4.1.2	9	9.8.1.1	7	9.12.1.5	6	9.1.3.4	8	9.9.3.2	11			9.1.4.2	4	9.1.1.1	6
		9.9.5.3	11			9.9.4.4	11					9.4.4.2	5	9.8.3.2	7			9.4.4.2	5	9.1.5.3	6
	21		36		23		34		16		15		23		24		23		27		27