

# INTERNATIONAL AEROBATIC CLUB SCORESHEET

# A

Contest:	Date:	Category: <b>Power Advanced</b>	Programme: <b>Unknown</b>	pilot's number	
----------	-------	--	------------------------------	-------------------	--





No	Symbol	Cat. No.	K	Total K	Grade	Remarks	Item	K	Score
1		5.3.2.1 9.1.2.2 9.9.5.2	24 6 11	<b>41</b>			<b>Presentation</b>	<b>30</b>	
2		8.4.1.1 9.1.1.3 9.9.5.3	13 10 11	<b>34</b>					
3		7.4.1.1 9.8.3.4	10 15	<b>25</b>					
4		1.2.5.1 9.1.4.4	14 8	<b>22</b>					
5		8.4.2.2 9.1.1.1 9.1.5.3	17 6 6	<b>29</b>					
6		1.1.6.1 9.8.1.1	10 7	<b>17</b>					
7		1.1.6.3 9.11.1.6	10 3	<b>13</b>					
8		8.6.1.1 9.1.1.1	11 6	<b>17</b>					
9		8.5.7.3 9.2.3.6 9.9.2.4	10 12 13	<b>35</b>					
10		7.2.3.3 9.4.3.2 9.1.3.3 9.4.3.3	6 5 6 8	<b>25</b>					

FIGURE TOTAL K = 258

INC. PRESENTATION = 288

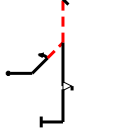
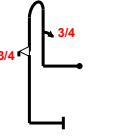
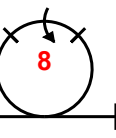
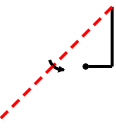
Aircraft type:

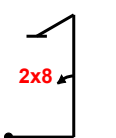
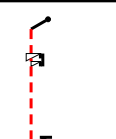
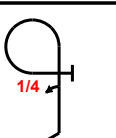
FREE PROGRAM CHECKED BY:

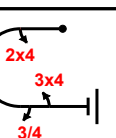
Signature:	Printed Name:	Date:
IAC No:		

Judge Name:

IAC #:

Assistant Name:

IAC #:



\_\_\_\_\_ Pilot  
 ..... A/C



<b>B</b>	Contest:	Category: Power Advanced
	Date:	Program: Unknown
		Pilot's No. <span style="border: 2px solid black; display: inline-block; width: 40px; height: 20px; vertical-align: middle;"></span>

Pilot:

wind direction

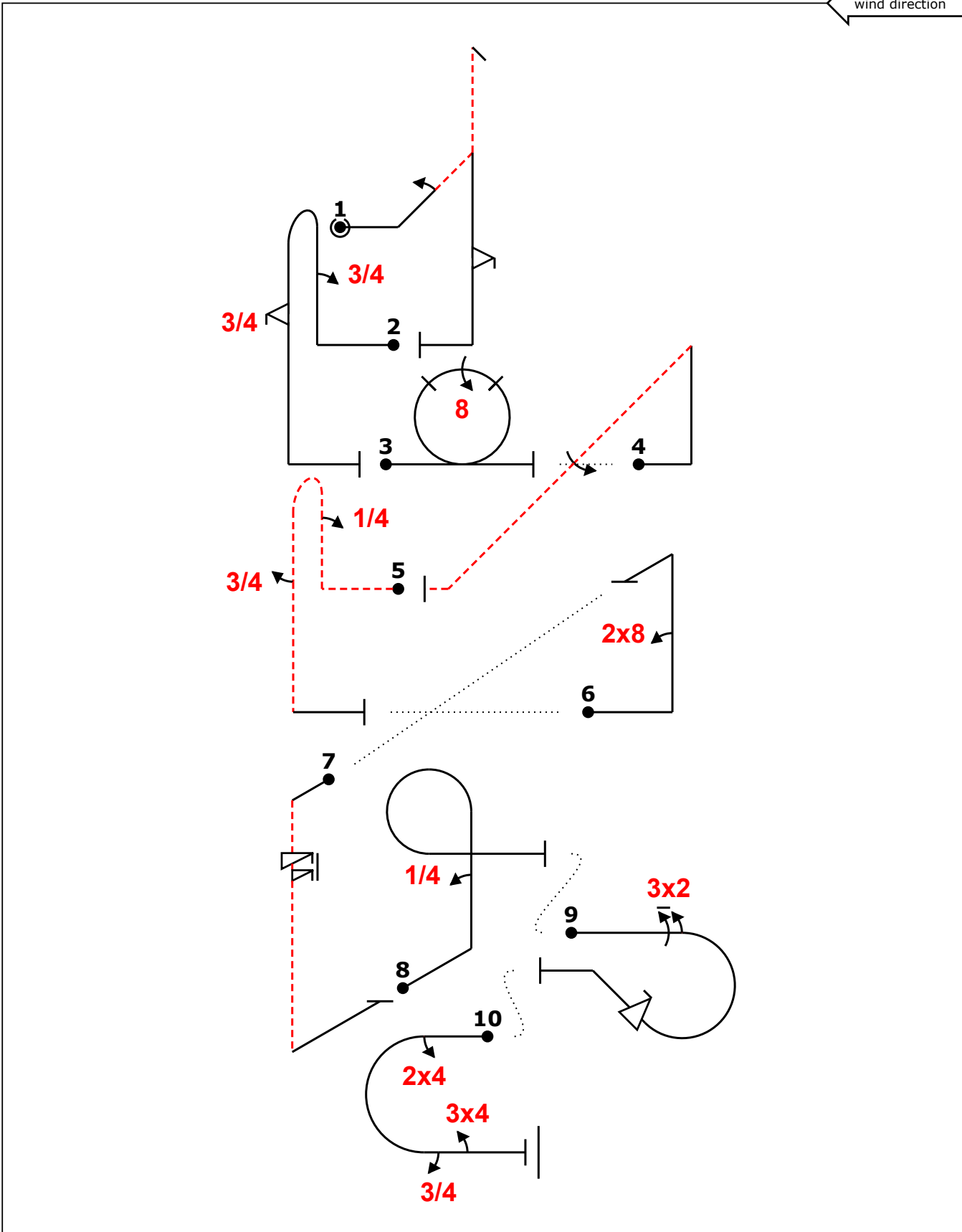

A/C:

(signature/date)

FREE PROGRAM CHECK BY:



<b>C</b>	Contest:	Category: Power Advanced
	Date:	Program: Unknown
		Pilot's No. <span style="border: 2px solid black; display: inline-block; width: 40px; height: 20px; vertical-align: middle;"></span>

Pilot:

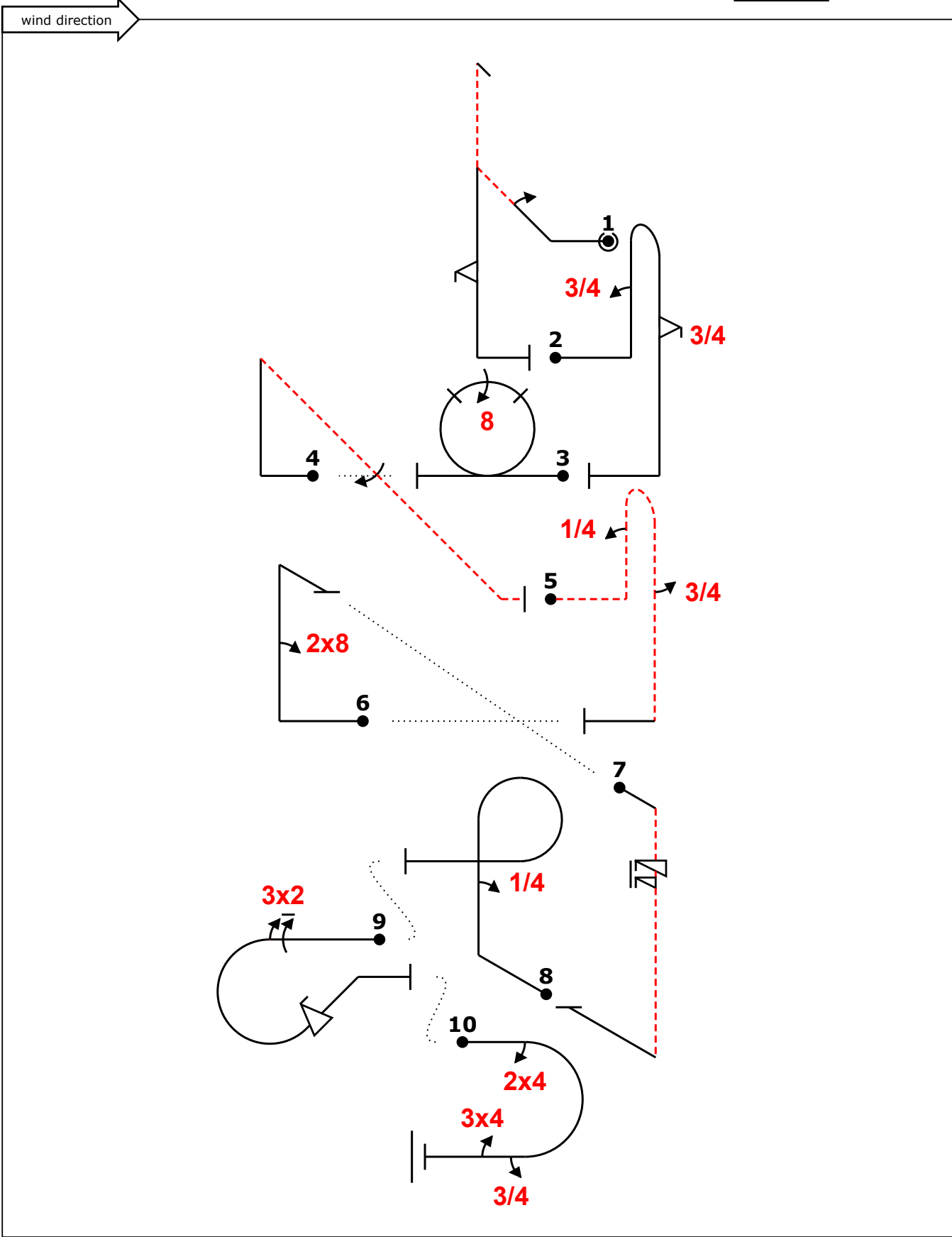

A/C:

(signature/date)

FREE PROGRAM CHECK BY:



Category: Power Advanced Date: \_\_\_\_\_  
 Program: Unknown

Figure K  
**258**  
 Total K  
**288**

Judge Name	IAC#	Pilot #
Asst. Name	IAC#	

wind direction **R**

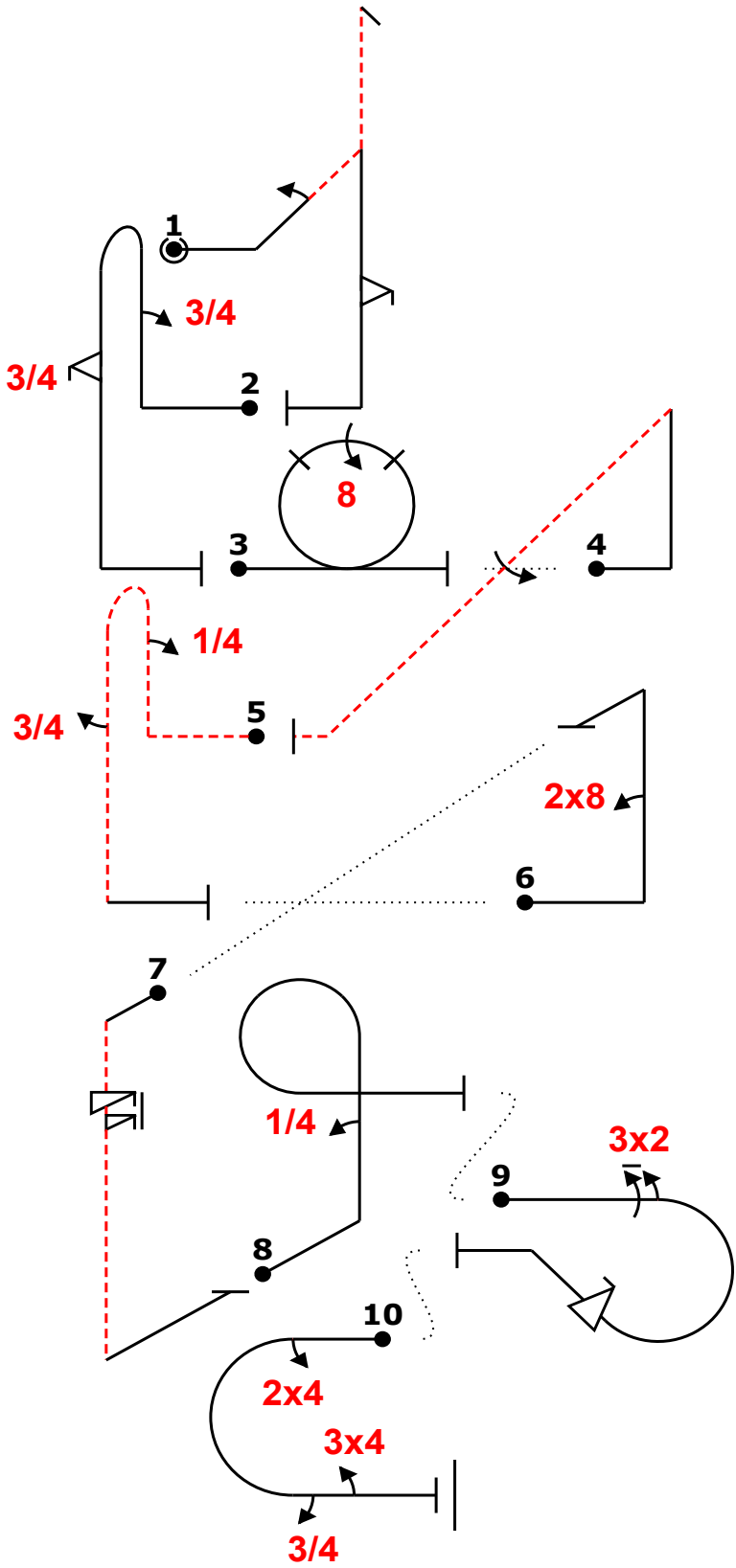

Fig	Grade	Remarks
1	.	
2	.	
3	.	
4	.	
5	.	
6	.	
7	.	
8	.	
9	.	
10	.	

Presentation **30** .

Fig 1	K	Fig 2	K	Fig 3	K	Fig 4	K	Fig 5	K	Fig 6	K	Fig 7	K	Fig 8	K	Fig 9	K	Fig 10	K
5.3.2.1	24	8.4.1.1	13	7.4.1.1	10	1.2.5.1	14	8.4.2.2	17	1.1.6.1	10	1.1.6.3	10	8.6.1.1	11	8.5.7.3	10	7.2.3.3	6
9.1.2.2	6	9.1.1.3	10	9.8.3.4	15	9.1.4.4	8	9.1.1.1	6	9.8.1.1	7	9.11.1.6	3	9.1.1.1	6	9.2.3.6	12	9.4.3.2	5
9.9.5.2	11	9.9.5.3	11					9.1.5.3	6							9.9.2.4	13	9.1.3.3	6
	<b>41</b>		<b>34</b>		<b>25</b>		<b>22</b>		<b>29</b>		<b>17</b>		<b>13</b>		<b>17</b>		<b>35</b>	9.4.3.3	<b>8</b>
																			<b>25</b>

Pilot: \_\_\_\_\_

A/C: \_\_\_\_\_



Category: Power Advanced	Date:
Program: Unknown	

Figure K  
258  
Total K  
288

Judge Name	IAC#	Pilot #
Asst. Name	IAC#	

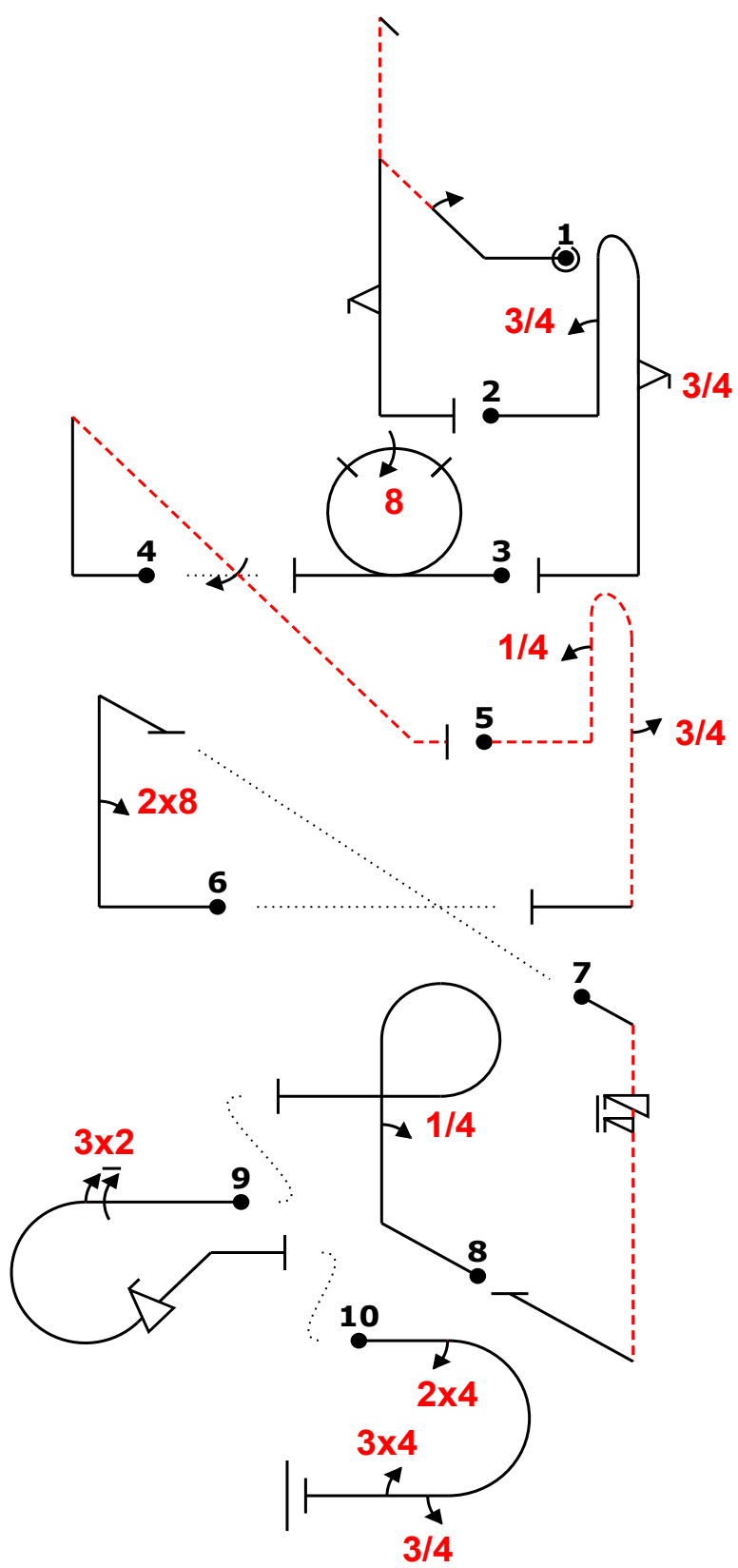
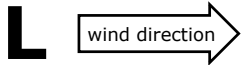

Fig	Grade	Remarks
1	.	
2	.	
3	.	
4	.	
5	.	
6	.	
7	.	
8	.	
9	.	
10	.	

Presentation	30	.
--------------	----	---

<b>Fig 1</b>	<b>K</b>	<b>Fig 2</b>	<b>K</b>	<b>Fig 3</b>	<b>K</b>	<b>Fig 4</b>	<b>K</b>	<b>Fig 5</b>	<b>K</b>	<b>Fig 6</b>	<b>K</b>	<b>Fig 7</b>	<b>K</b>	<b>Fig 8</b>	<b>K</b>	<b>Fig 9</b>	<b>K</b>	<b>Fig 10</b>	<b>K</b>
5.3.2.1	24	8.4.1.1	13	7.4.1.1	10	1.2.5.1	14	8.4.2.2	17	1.1.6.1	10	1.1.6.3	10	8.6.1.1	11	8.5.7.3	10	7.2.3.3	6
9.1.2.2	6	9.1.1.3	10	9.8.3.4	15	9.1.4.4	8	9.1.1.1	6	9.8.1.1	7	9.11.1.6	3	9.1.1.1	6	9.2.3.6	12	9.4.3.2	5
9.9.5.2	11	9.9.5.3	11					9.1.5.3	6					9.9.2.4	13	9.1.3.3	6	9.4.3.3	8
	<b>41</b>		<b>34</b>		<b>25</b>		<b>22</b>		<b>29</b>		<b>17</b>		<b>13</b>		<b>17</b>		<b>35</b>		<b>25</b>