

# INTERNATIONAL AEROBATIC CLUB SCORESHEET

# A

Contest:

Date:



Category:

 Power  
Advanced

Programme:

Unknown

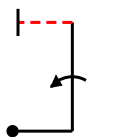
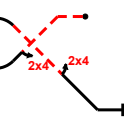
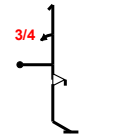
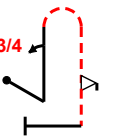
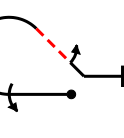
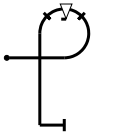
 pilot's  
number

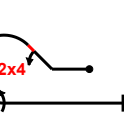
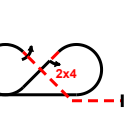
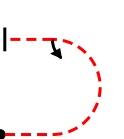
No	Symbol	Cat. No.	K	Total K	Grade	Remarks	Item	K	Score	
1		1.1.7.1 9.1.1.4	9 12	<b>21</b>			<b>Presentation</b>	<b>30</b>		
2		7.3.4.4 9.4.4.2 9.4.4.2	15 5 5	<b>25</b>			FIGURE TOTAL K =	274		
3		5.2.1.1 9.1.1.3 9.9.5.2	17 10 11	<b>38</b>			INC. PRESENTATION =	304		
4		8.4.3.1 9.1.1.3 9.9.10.2	15 10 13	<b>38</b>			Aircraft type:			
5		8.5.6.1 9.1.3.4 9.1.4.2	10 8 4	<b>22</b>			FREE PROGRAM CHECKED BY:  Signature: _____ Printed Name: _____ IAC No: _____ Date: _____			
6		8.6.5.1 9.9.3.4	11 11	<b>22</b>				Judge Name:		
7		5.3.2.1 9.1.2.2 9.1.1.1 9.1.5.1	24 6 6 2	<b>38</b>				IAC #		
8		8.5.2.1 9.4.2.2 9.1.3.4	10 7 8	<b>25</b>				Assistant Name:		
9		7.8.3.1 9.4.4.2 9.1.4.4	19 5 8	<b>32</b>				IAC #		
10		7.2.2.2 9.1.3.2	9 4	<b>13</b>						



\_\_\_\_\_ Pilot  
 \_\_\_\_\_ A/C



<b>B</b>	Contest:	Category: Power Advanced
	Date:	Program: Unknown
		Pilot's No. <span style="border: 1px solid black; display: inline-block; width: 40px; height: 20px; vertical-align: middle;"></span>

Pilot:

wind direction

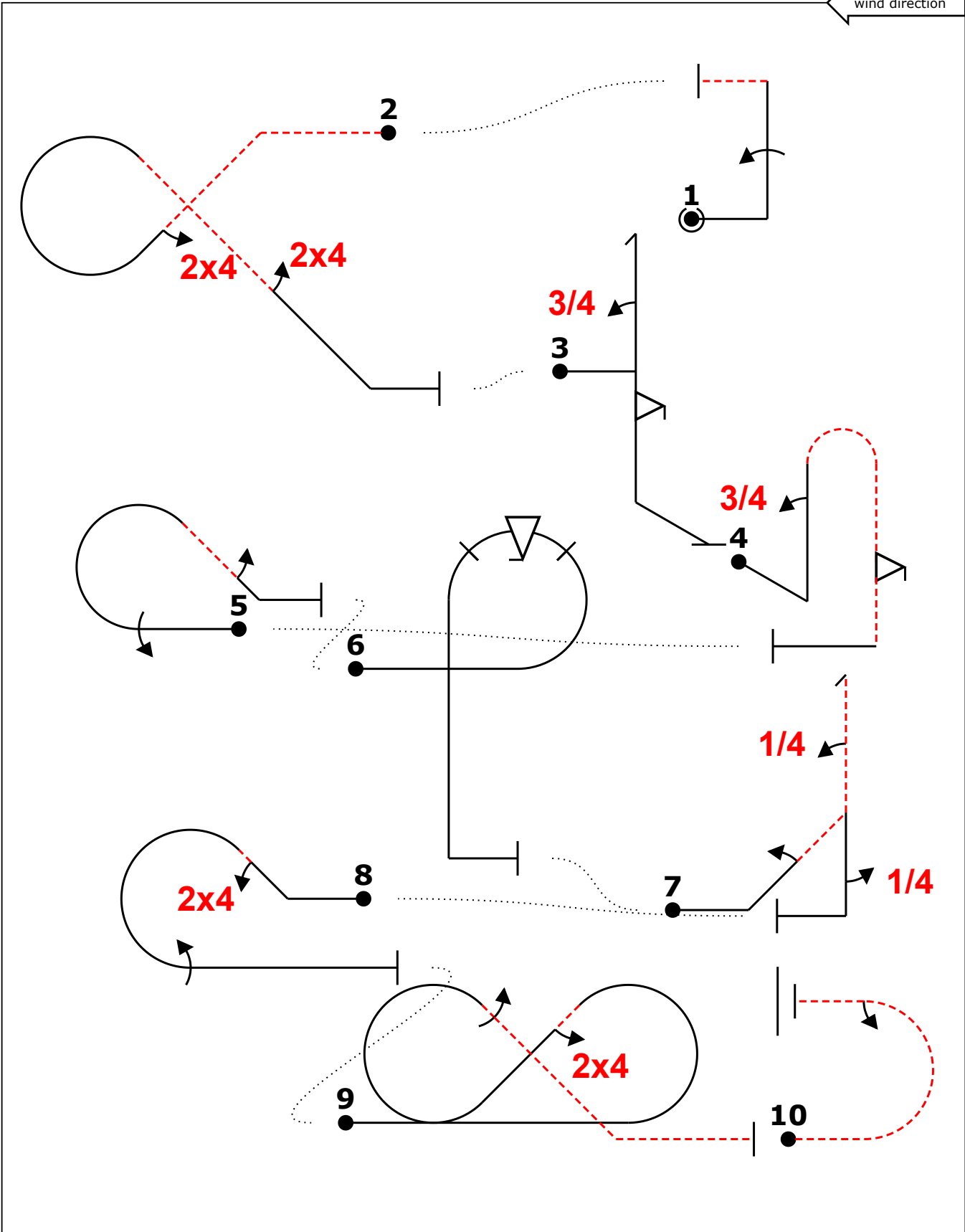

A/C:

(signature/date)

FREE PROGRAM CHECK BY:



<b>C</b>	Contest:	Category: Power Advanced
	Date:	Program: Unknown
		Pilot's No. <input type="text"/>

Pilot:

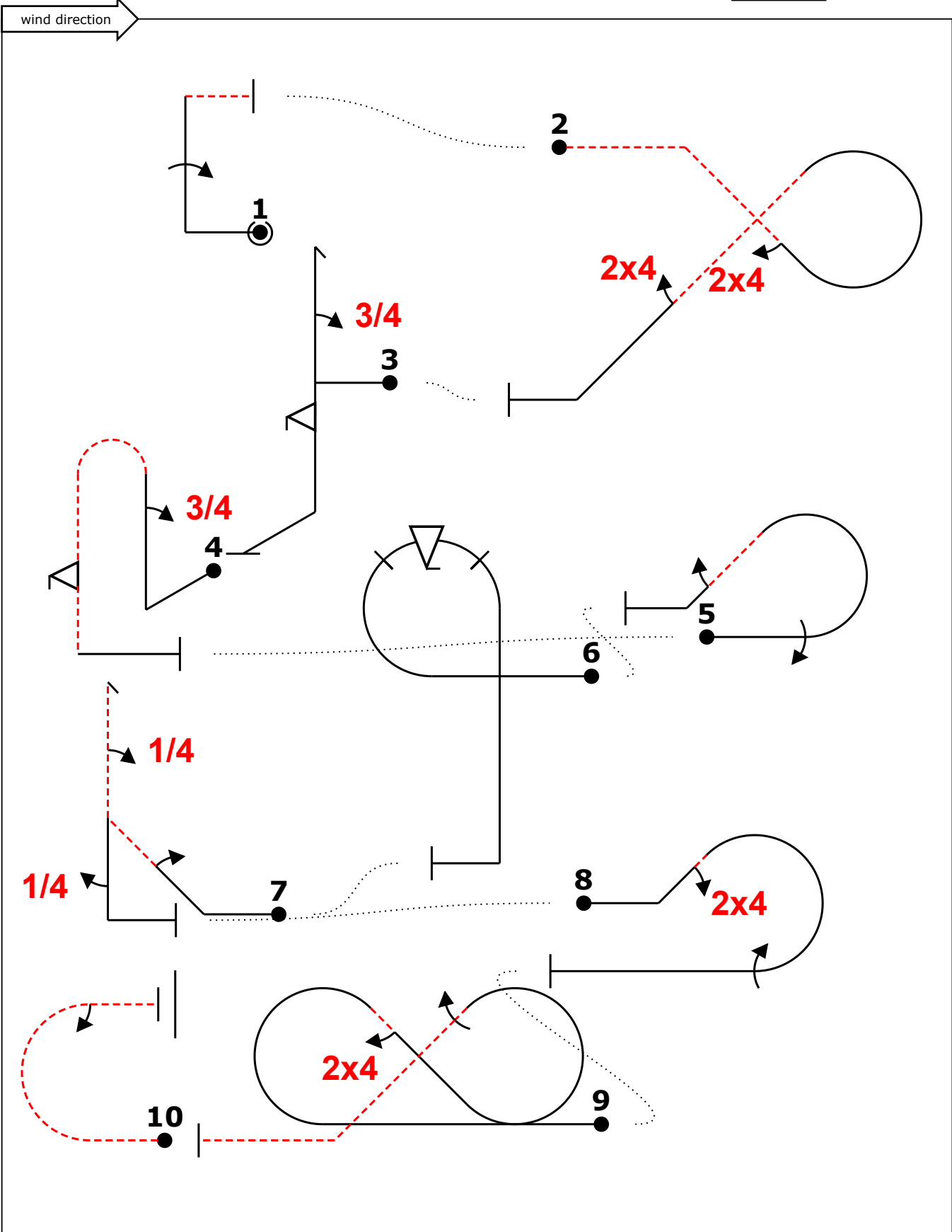

A/C:

(signature/date)

FREE PROGRAM CHECK BY:



Category: Power Advanced Date: \_\_\_\_\_  
 Program: Unknown

Figure K  
**274**  
 Total K  
**304**

Judge Name	IAC#	Pilot #
Asst. Name	IAC#	

wind direction **R**

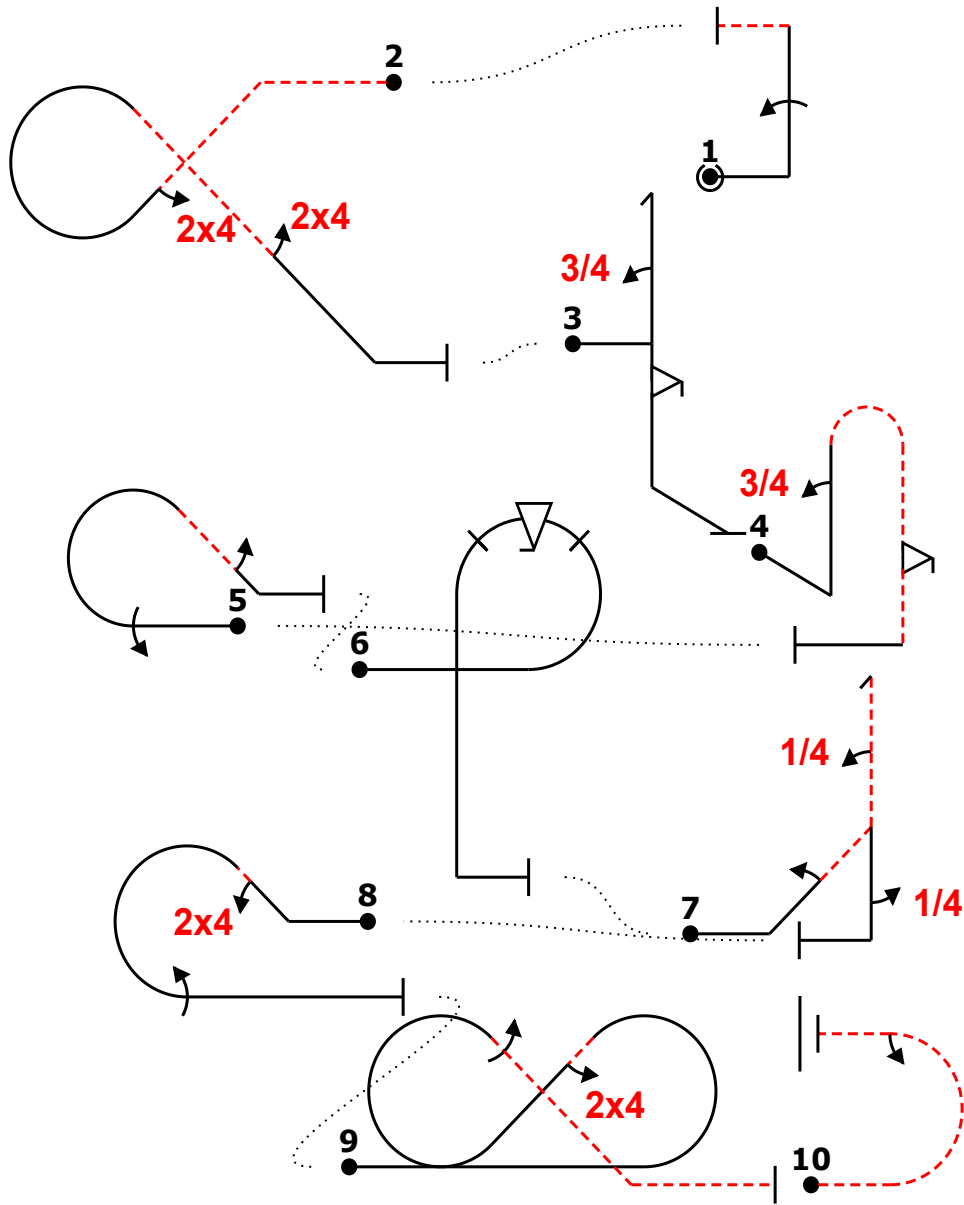

Fig	Grade	Remarks
1	.	
2	.	
3	.	
4	.	
5	.	
6	.	
7	.	
8	.	
9	.	
10	.	

v1- (-14,3) --24ig.24.. (3,-1) /3h`2f.+ 3pb2f (-27,-1) -1% .....1c''2'''''''' (-2,4) 'p(f)..' (5,3) 2dh(4)  
 4 (-20,-1) .....24''''rc1+'' (-7,9) cc(24)'1- -m2-

Presentation **30** .

Fig 1	K	Fig 2	K	Fig 3	K	Fig 4	K	Fig 5	K	Fig 6	K	Fig 7	K	Fig 8	K	Fig 9	K	Fig 10	K
1.1.7.1	9	7.3.4.4	15	5.2.1.1	17	8.4.3.1	15	8.5.6.1	10	8.6.5.1	11	5.3.2.1	24	8.5.2.1	10	7.8.3.1	19	7.2.2.2	9
9.1.1.4	12	9.4.4.2	5	9.1.1.3	10	9.1.1.3	10	9.1.3.4	8	9.9.3.4	11	9.1.2.2	6	9.4.2.2	7	9.4.4.2	5	9.1.3.2	4
		9.4.4.2	5	9.9.5.2	11	9.9.10.2	13	9.1.4.2	4			9.1.1.1	6	9.1.3.4	8	9.1.4.4	8		
												9.1.5.1	2						
	<b>21</b>		<b>25</b>		<b>38</b>		<b>38</b>		<b>22</b>		<b>22</b>		<b>38</b>		<b>25</b>		<b>32</b>		<b>13</b>

Pilot: \_\_\_\_\_ A/C: \_\_\_\_\_



Category: Power Advanced Date: \_\_\_\_\_  
 Program: Unknown

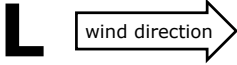

Figure K <b>274</b>	Judge Name	IAC#	Pilot #
Total K <b>304</b>	Asst. Name	IAC#	

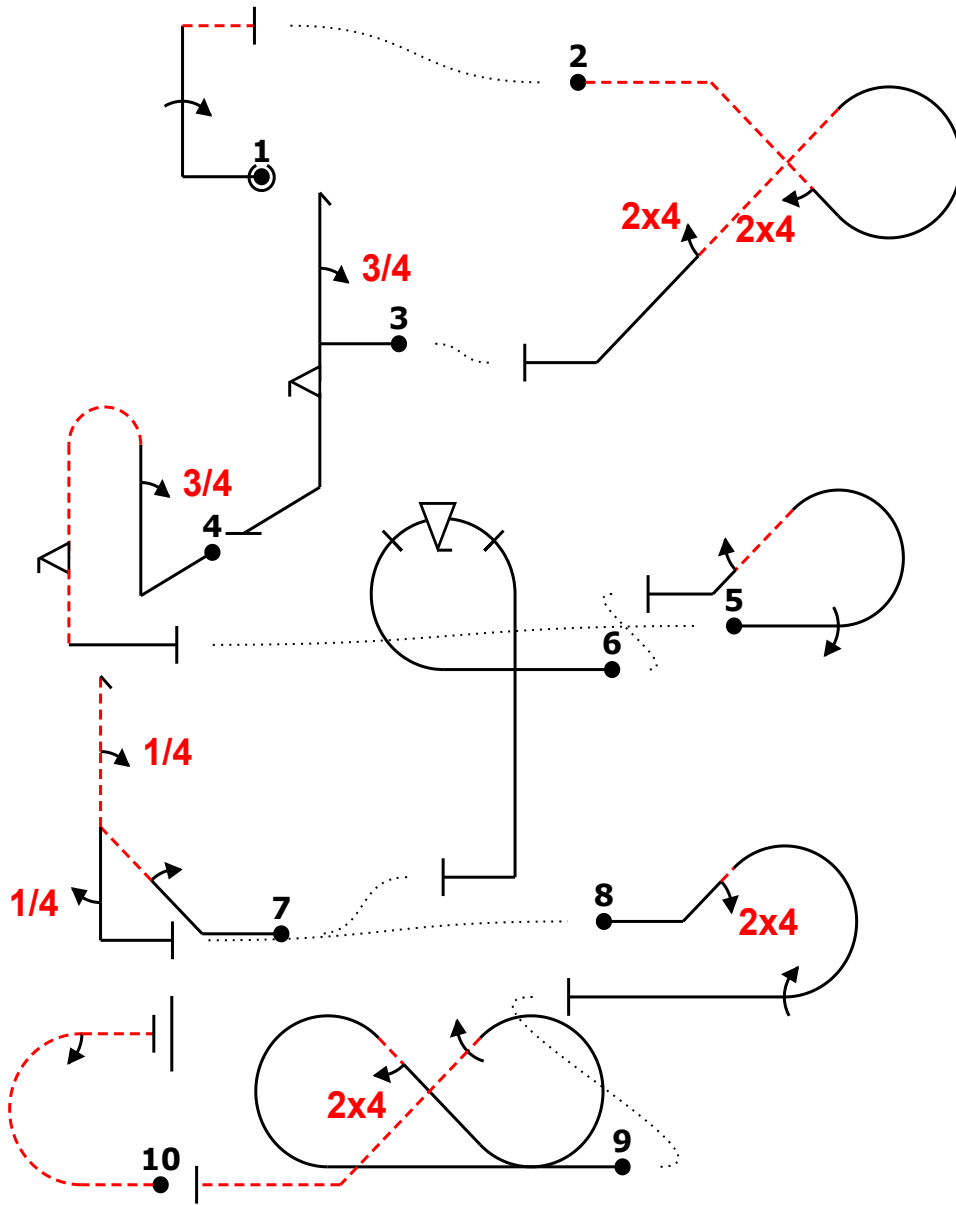

Fig	Grade	Remarks
1	.	
2	.	
3	.	
4	.	
5	.	
6	.	
7	.	
8	.	
9	.	
10	.	

v1- (-14,3) --24ig.24.. (3,-1) /3h`2f.+ 3pb2f (-27,-1) -1% .....1c`2`..... (-2,4) 'p(f).'' (5,3) 2dh(4)  
 4 (-20,-1) .....24`rc1+` (-7,9) cc(24)`1- -m2-

Presentation **30** .

Fig 1	K	Fig 2	K	Fig 3	K	Fig 4	K	Fig 5	K	Fig 6	K	Fig 7	K	Fig 8	K	Fig 9	K	Fig 10	K
1.1.7.1	9	7.3.4.4	15	5.2.1.1	17	8.4.3.1	15	8.5.6.1	10	8.6.5.1	11	5.3.2.1	24	8.5.2.1	10	7.8.3.1	19	7.2.2.2	9
9.1.1.4	12	9.4.4.2	5	9.1.1.3	10	9.1.1.3	10	9.1.3.4	8	9.9.3.4	11	9.1.2.2	6	9.4.2.2	7	9.4.4.2	5	9.1.3.2	4
		9.4.4.2	5	9.9.5.2	11	9.9.10.2	13	9.1.4.2	4			9.1.1.1	6	9.1.3.4	8	9.1.4.4	8		
												9.1.5.1	2						
	<b>21</b>		<b>25</b>		<b>38</b>		<b>38</b>		<b>22</b>		<b>22</b>		<b>38</b>		<b>25</b>		<b>32</b>		<b>13</b>

Pilot: \_\_\_\_\_

A/C: \_\_\_\_\_