

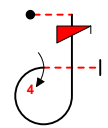
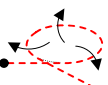
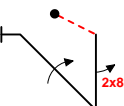
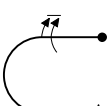
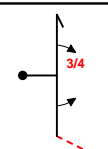
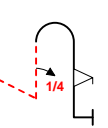
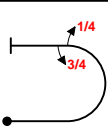
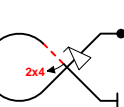
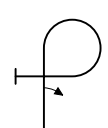

INTERNATIONAL AEROBATIC CLUB SCORESHEET

A	Contest:	Date:	Category: Advanced	Programme: Unknown	pilot's number	

No	Symbol	Catalogue No.	K	Total K	Grade	Remarks
1		8.6.1.4 9.12.1.4 9.4.3.4	12 7 11	30		
2		2.3.4.4	34	34		
3		1.2.5.4 9.8.5.1 9.1.2.4	14 3 10	27		
4		7.2.3.3 9.1.3.6	6 10	16		
5		5.2.1.3 9.1.1.3 9.1.5.2	18 10 4	32		
6		8.4.4.2 9.1.1.1 9.9.5.2	14 6 11	31		
7		7.2.2.1 9.1.3.1 9.1.3.3	6 2 6	14		
8		7.3.3.3 9.9.4.4 9.4.4.2	14 11 5	30		
9		8.6.1.1 9.1.1.2	11 8	19		
10		1.2.5.1 9.2.4.4	14 9	23		
11		7.4.3.2	19	19		

Presentation	12	
---------------------	-----------	--

FIGURE TOTAL K = 275

INCLUDING PRESENTATION = 287

Aircraft Type:

FREE PROGRAM CHECKED BY:

Signature:	Printed Name:	Date:
		IAC No.

Judge Name:

IAC#

Assistant Name:

IAC#



Pilot NAC



B	Contest:	Category: Advanced	
	Date:	Program: Unknown	Pilot's No. <input type="text"/>

wind direction

Pilot
NAC

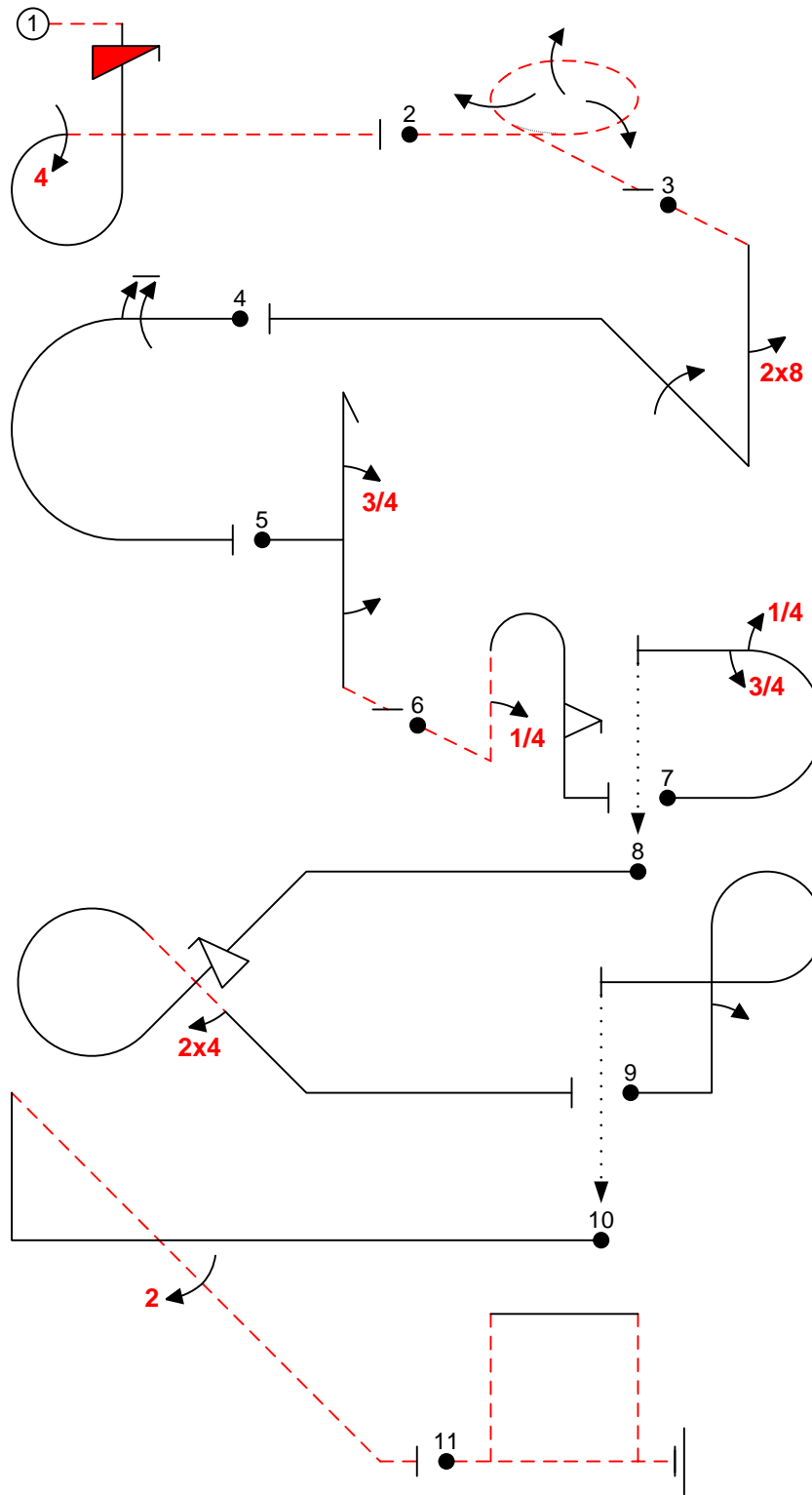

A/C:

(signature/date)

FREE PROGRAM CHECK BY:



C	Contest:	Category: Advanced
	Date:	Program: Unknown

pilot
NAC

wind direction

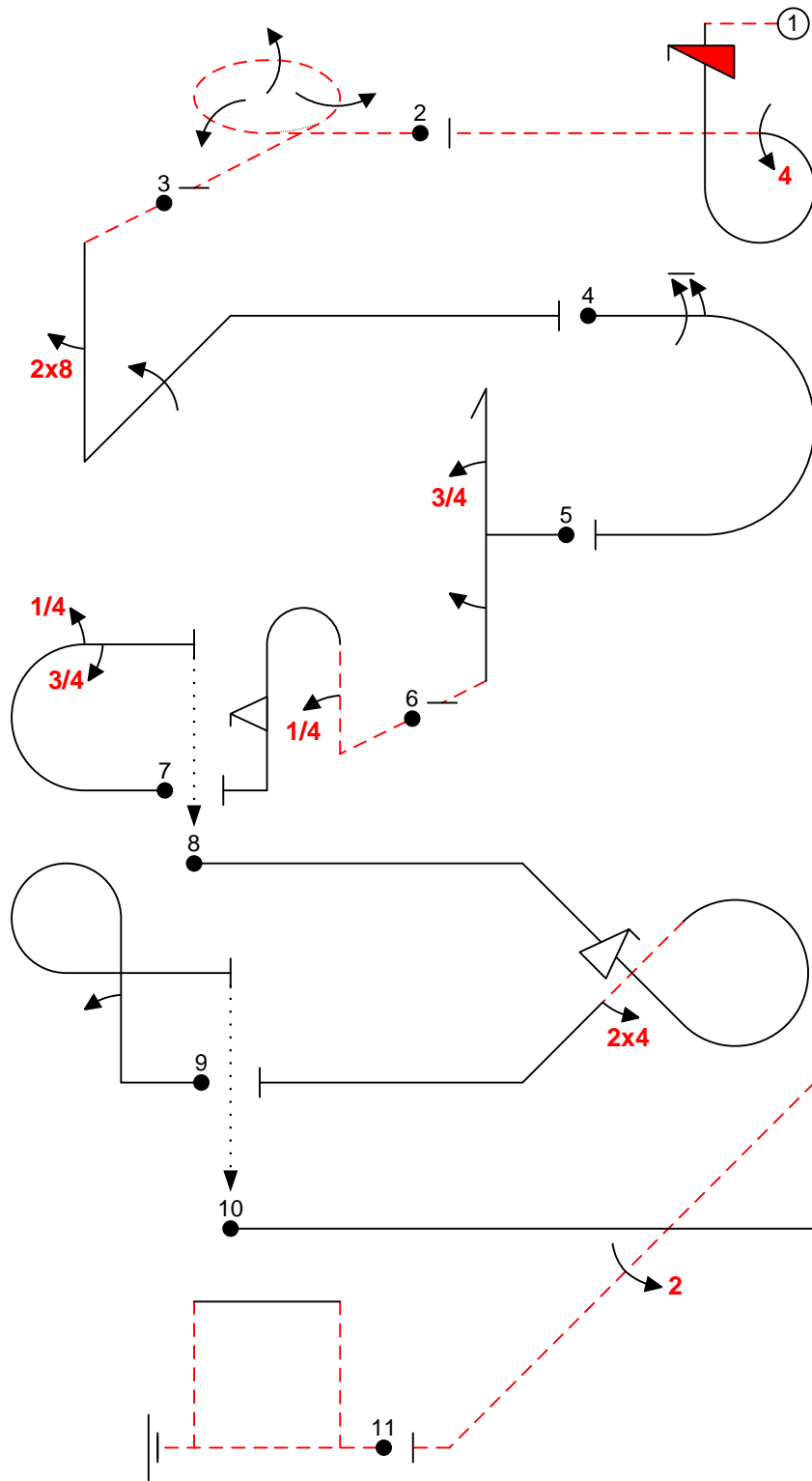

Created Using Aresti 2013™ software. ACCassidy@aol.com

A/C:

(signature/date)

FREE PROGRAM CHECK BY: