

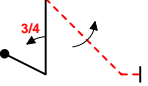

INTERNATIONAL AEROBATIC CLUB SCORESHEET

A	Contest:	Date:	Category: <b>Advanced</b>	Programme: <b>Unknown</b>	pilot's number	

No	Symbol	Catalogue No.	K	Total K	Grade	Remarks	Item	K	Score
1		1.2.5.1 9.1.1.3 9.1.4.4	14 10 8	32			<div style="border: 1px solid black; padding: 5px; margin-bottom: 5px;"><b>Presentation</b></div> <div style="border: 1px solid black; padding: 5px; margin-bottom: 5px;">FIGURE TOTAL K = 275</div> <div style="border: 1px solid black; padding: 5px; margin-bottom: 5px;">INCLUDING PRESENTATION = 287</div> <div style="border: 1px solid black; padding: 5px; margin-bottom: 5px;">Aircraft Type:</div> <div style="border: 1px solid black; padding: 5px; margin-bottom: 5px;"> <div style="display: flex; justify-content: space-between;"> <div style="width: 60%; border-right: 1px solid black; padding-right: 5px;"> <p style="writing-mode: vertical-rl; transform: rotate(180deg); font-weight: bold;">FREE PROGRAM CHECKED BY:</p> <p>Signature:</p> </div> <div style="width: 30%; border-right: 1px solid black; padding-right: 5px;"> <p>Printed Name:</p> </div> <div style="width: 10%; padding: 5px;"> <p>Date:</p> </div> </div> </div> <div style="border: 1px solid black; padding: 5px; margin-bottom: 5px;">Judge Name:</div> <div style="border: 1px solid black; padding: 5px; margin-bottom: 5px;">IAC#</div> <div style="border: 1px solid black; padding: 5px; margin-bottom: 5px;">Assistant Name:</div> <div style="border: 1px solid black; padding: 5px; margin-bottom: 5px;">IAC#</div> <div style="text-align: center; margin-top: 20px;">  </div> <div style="text-align: right; margin-top: 20px;"> <p style="font-style: italic;">pilot</p> </div>	12	
2		8.6.3.2 9.1.3.4	13 8	21					
3		8.4.3.1 9.1.1.2 9.9.10.2	15 8 13	36					
4		8.5.8.1 9.1.3.6 9.1.4.2	14 10 4	28					
5		5.3.1.4 9.1.1.1 9.1.5.2	23 6 4	33					
6		8.4.1.1 9.1.1.2 9.1.5.3	13 8 6	27					
7		7.2.1.1 9.2.3.4 9.1.3.2 9.9.3.2	6 9 4 11	30					
8		1.1.7.4 9.4.5.2	9 5	14					
9		1.2.1.1 9.9.2.4 9.8.5.1	13 13 3	29					
10		5.2.1.3 9.8.1.1	18 7	25					

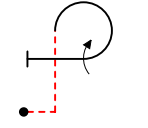
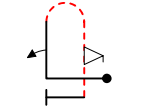
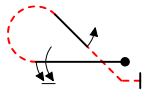
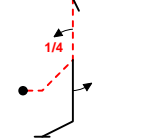
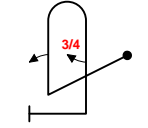
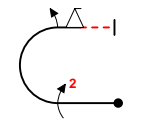
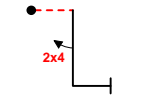
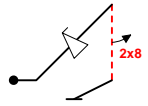
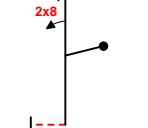

<b>B</b>	Contest:	Category: <b>Advanced</b>
Date:	Program: <b>Unknown</b>	Pilot's No. <input type="text"/>

wind direction

Pilot:

NOTE CROSS-BOX ENTRY

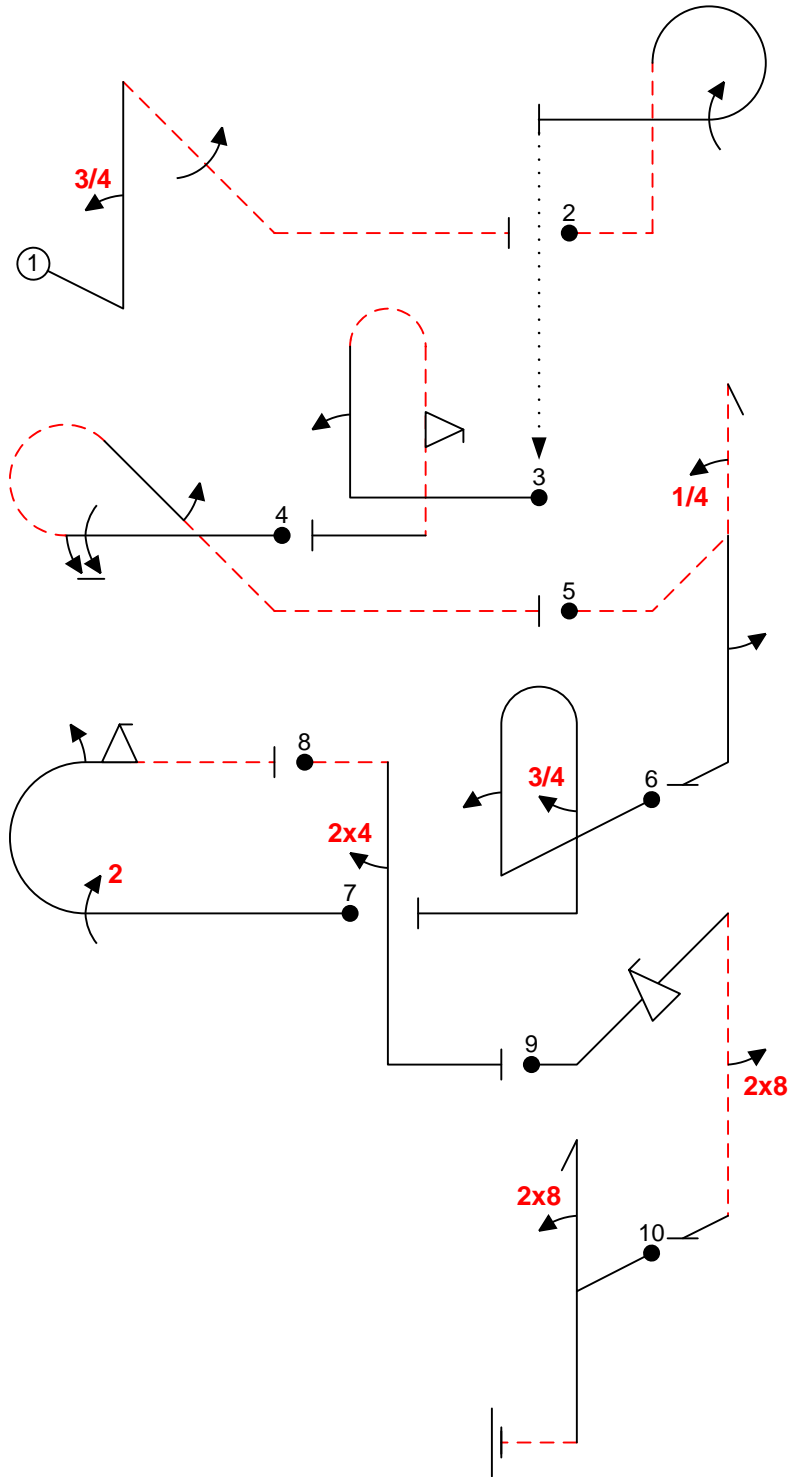

A/C:

(signature/date)

FREE PROGRAM CHECK BY:



<b>C</b>	Contest:	Category: <b>Advanced</b>
Date:	Program: <b>Unknown</b>	Pilot's No. <input type="text"/>

wind direction

NOTE CROSS-BOX ENTRY

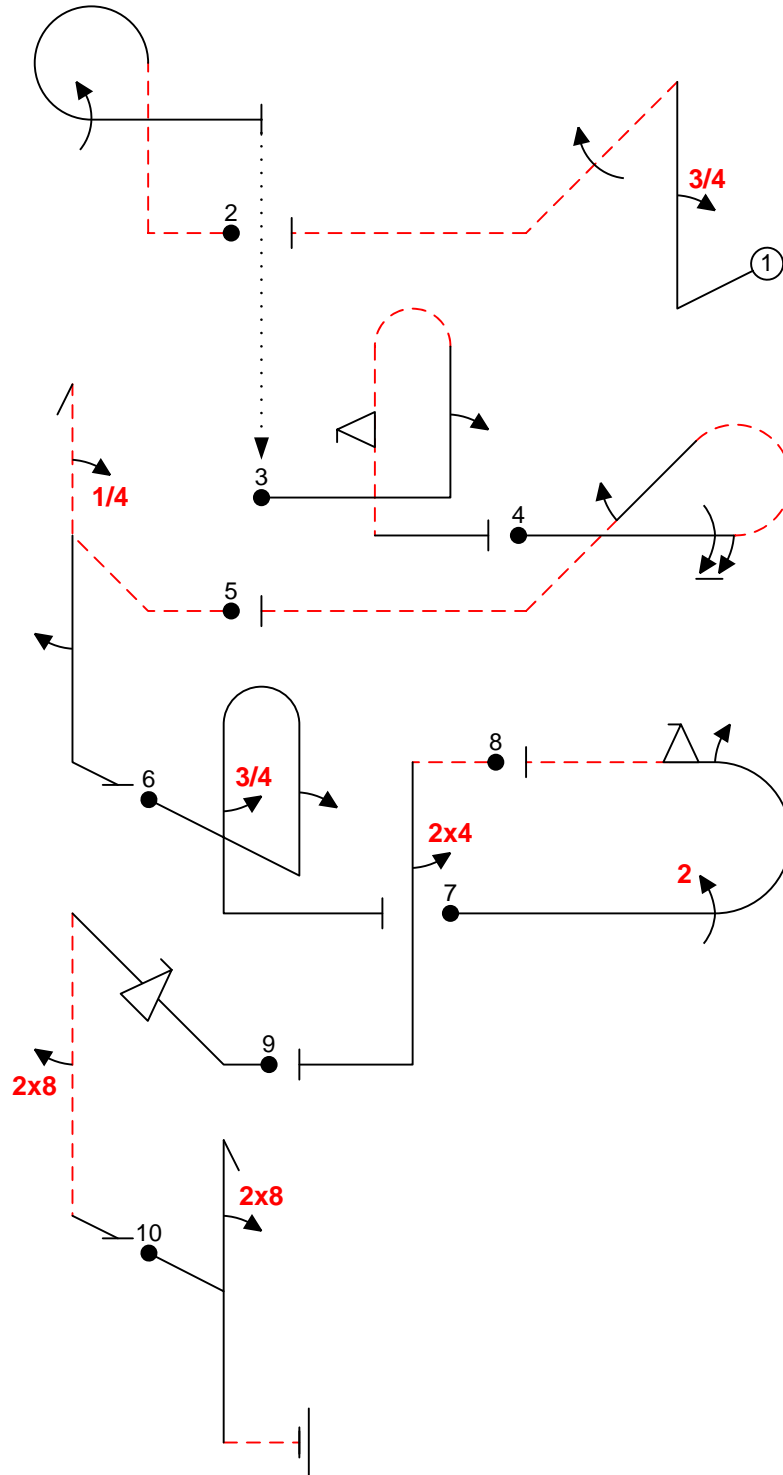

Pilot: \_\_\_\_\_

A/C: \_\_\_\_\_

(signature/date)

FREE PROGRAM CHECK BY: \_\_\_\_\_