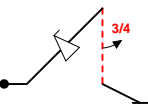
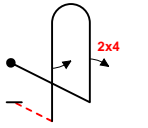
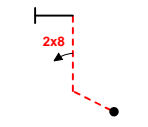
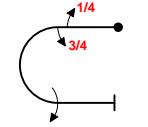
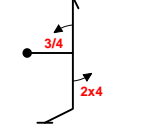
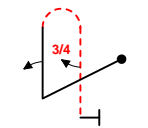
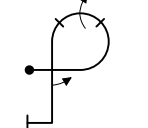
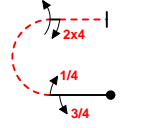
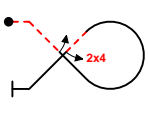
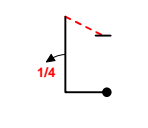
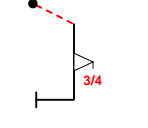

INTERNATIONAL AEROBATIC CLUB SCORESHEET

**A**

Contest:	Date:	Category: <b>Advanced</b>	Programme: <b>Unknown</b>	pilot's number	
----------	-------	------------------------------	------------------------------	----------------	--

No	Symbol	Catalogue No.	K	Total K	Grade	Remarks
1		1.12.1 9.9.2.4 9.1.5.3	13 13 6	32		
2		8.2.1 9.4.1.2 9.1.5.2	14 9 4	27		
3		1.7.2 9.8.1.1	12 7	19		
4		7.3.3 9.1.3.1 9.1.3.3 9.1.3.4	6 2 6 8	22		
5		5.1.1 9.1.1.3 9.4.5.2	17 10 5	32		
6		8.3.1 9.1.1.2 9.1.5.3	15 8 6	29		
7		8.43.1 9.4.3.4 9.1.5.2	11 11 4	26		
8		7.4.1 9.1.3.3 9.1.3.1 9.1.3.4 9.4.3.2	8 6 2 8 5	29		
9		7.22.4 9.1.4.2 9.4.4.2	15 4 5	24		
10		1.7.1 9.1.1.1	9 6	15		
11		1.7.4 9.9.5.3	9 11	20		

<b>Presentation</b>	<b>12</b>	
---------------------	-----------	--

FIGURE TOTAL K = **275**

INCLUDING PRESENTATION = **287**

Aircraft Type:

FREE PROGRAM CHECKED BY:

Signature:	Printed Name:	Date:
IAC No.		

Judge
Name
Number



pilot



<b>B</b>	Contest:	Category: <b>Advanced</b>
	Date:	Program: <b>Unknown</b>

wind direction

Pilot:

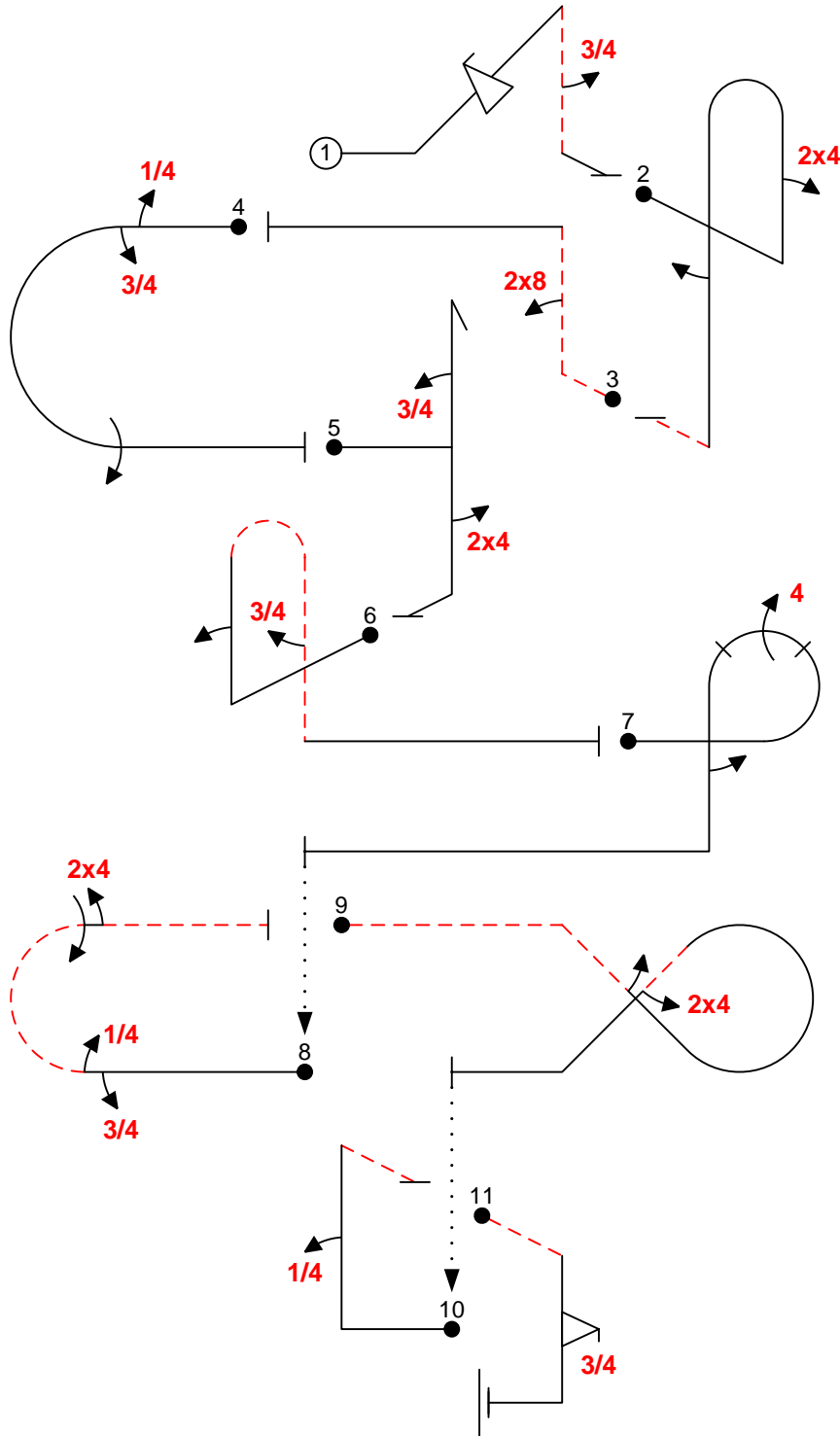

A/C:

(signature/date)

FREE PROGRAM CHECK BY:



<b>C</b>	Contest:	Category: <b>Advanced</b>
Date:	Program: <b>Unknown</b>	Pilot's No. <input type="text"/>

wind direction

Pilot: \_\_\_\_\_

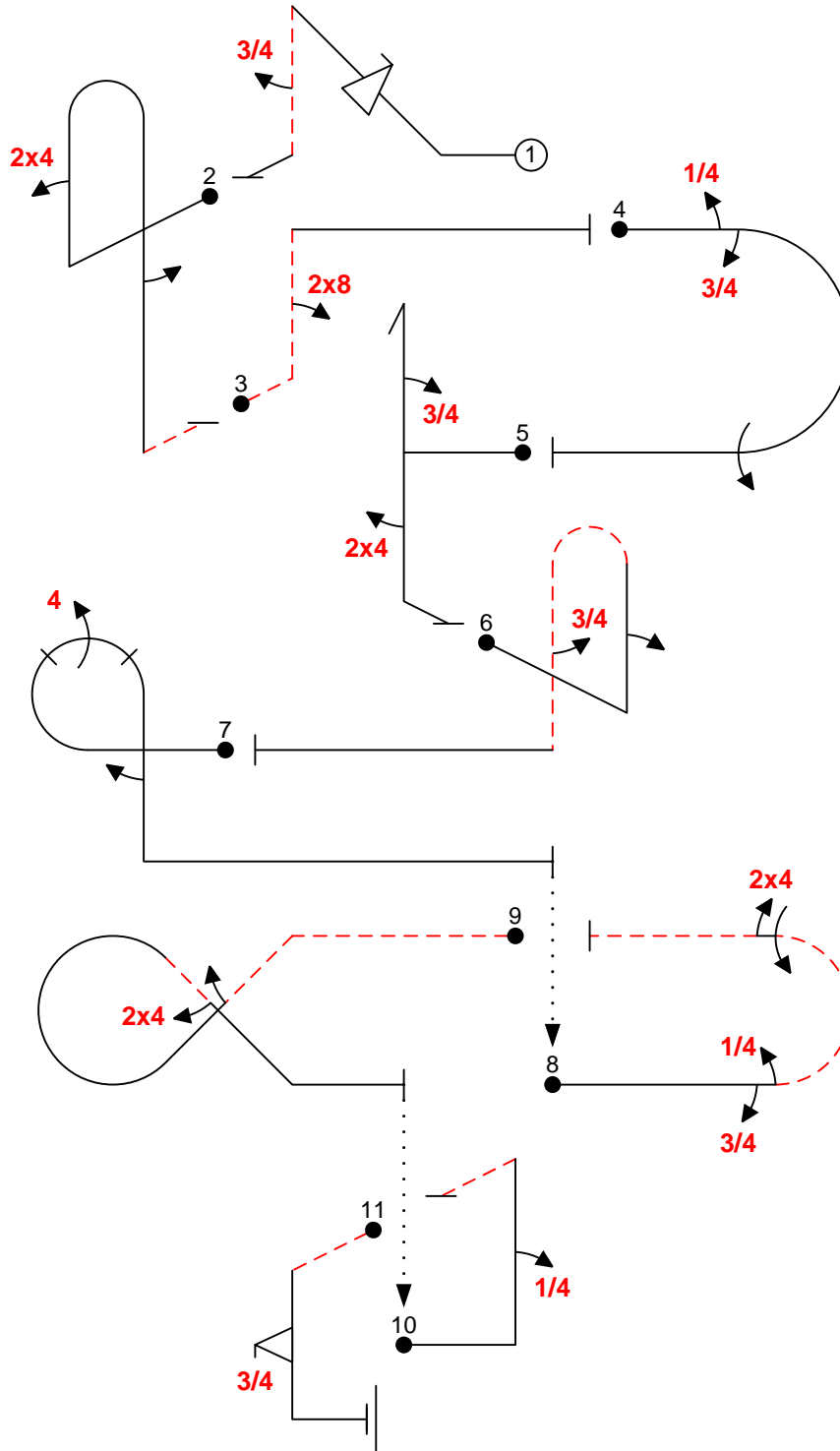

A/C: \_\_\_\_\_

(signature/date)

FREE PROGRAM CHECK BY: \_\_\_\_\_