

INTERNATIONAL AEROBATIC CLUB SCORESHEET

A

Contest:

Date:

Category:

Programme:

pilot's number

Advanced

Unknown



No	Symbol	Catalogue No.	K	Total K	Grade	Remarks	Item	K	Score
1		2.17.3	26	26			Presentation	12	
2		1.7.4 9.12.1.6	9 5	14					
3		5.3.1 9.1.2.2 9.1.1.1 9.1.5.2	24 6 6 4	40					
4		8.3.1 9.1.1.3 9.9.10.2	15 10 13	38					
5		7.9.1	15	15					
6		7.2.1 9.1.3.8 9.4.3.2 9.9.3.4	6 12 5 11	34					
7		1.15.3 9.1.4.2 9.1.1.1	14 4 6	24					
8		1.7.4 9.9.5.3	9 11	20					
9		8.40.1 9.4.1.2 9.1.3.6	14 9 10	33					
10		8.1.1 9.4.5.2	13 5	18					
11		1.1.1 9.4.3.4	2 11	13					

FIGURE TOTAL K = **275**

INCLUDING PRESENTATION = **287**

Aircraft Type:

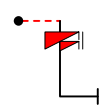
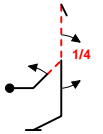
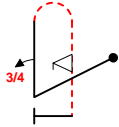
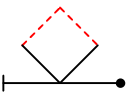
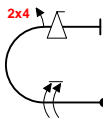
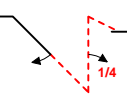
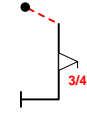
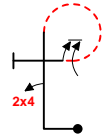
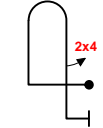
FREE PROGRAM CHECKED BY:

Signature:	Printed Name:	Date:
		IAC No.

Judge
Name
Number



pilot



B	Contest:	Category: Advanced
Date:	Program: Unknown	Pilot's No. <input type="text"/>

wind direction

Pilot:

NOTE DOWNWIND START

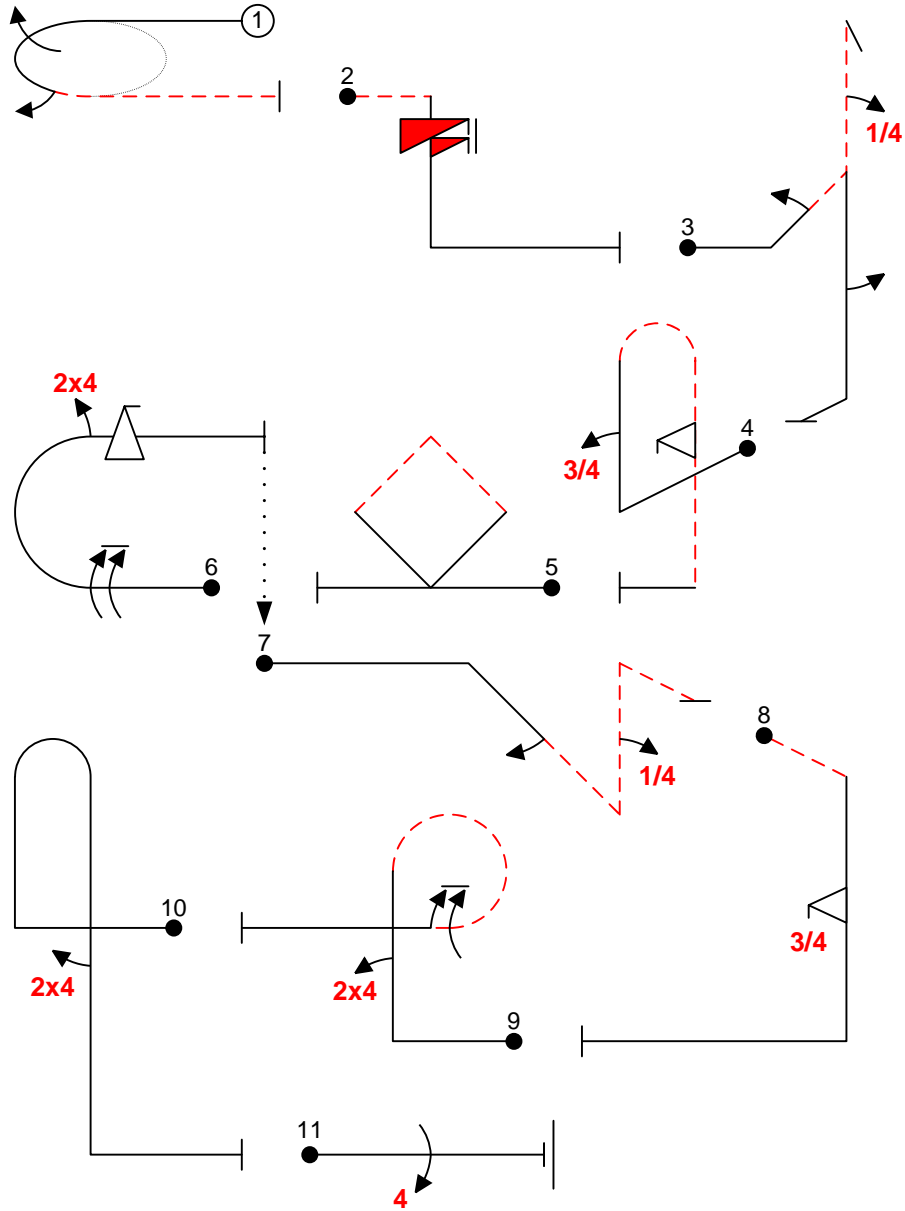

A/C:

(signature/date)

FREE PROGRAM CHECK BY:



C	Contest:	Category: Advanced
Date:	Program: Unknown	Pilot's No. <input type="text"/>

wind direction

NOTE DOWNWIND START

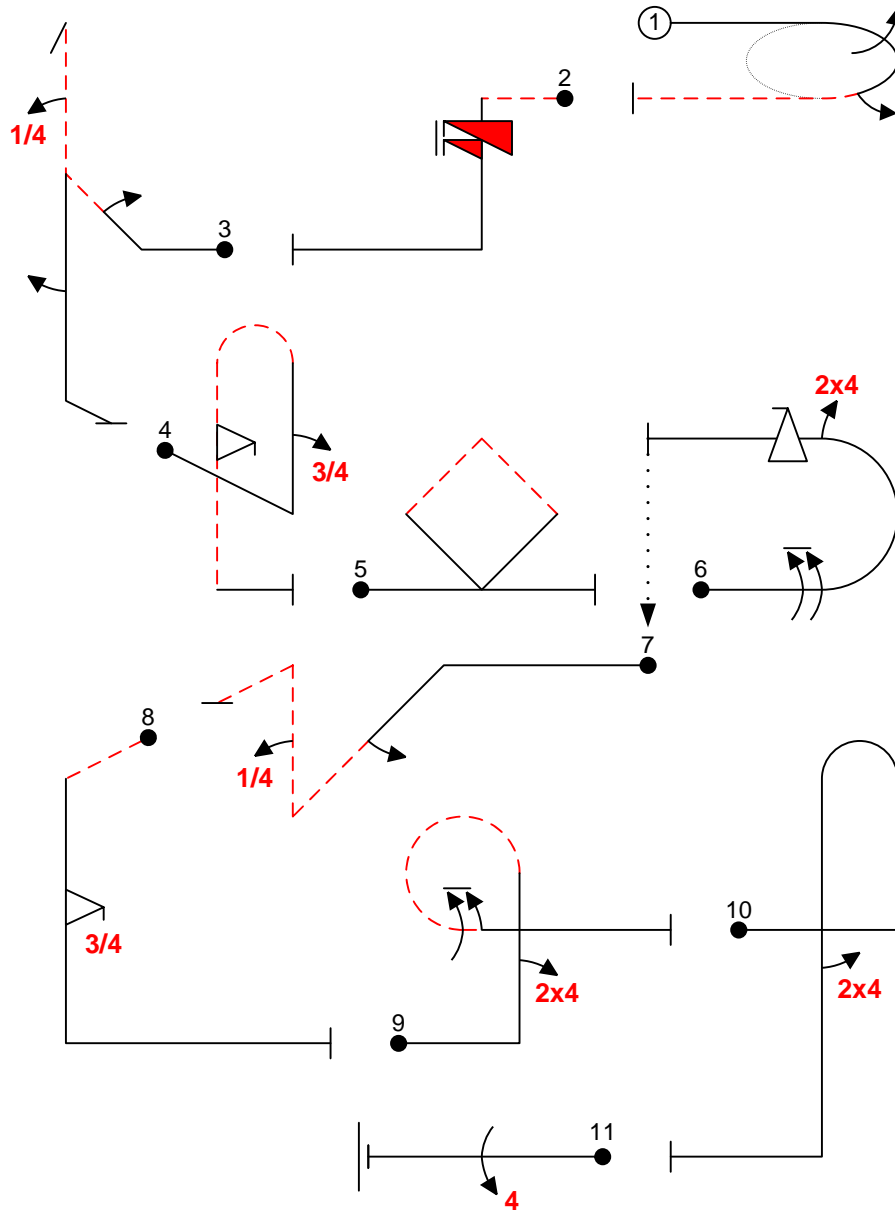

Pilot: _____

A/C: _____

(signature/date)

FREE PROGRAM CHECK BY: _____