

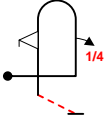
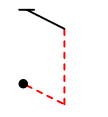
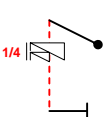
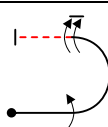
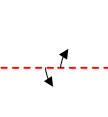
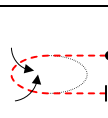
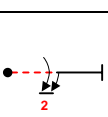
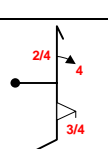
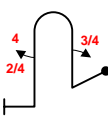
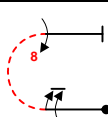

INTERNATIONAL AEROBATIC CLUB SCORESHEET

A	Contest:	Date:	Category:	Programme:	pilot's number	
			Advanced	Unknown		

No	Symbol	Catalogue No.	K	Total K	Score	Remarks
1		8.2.1 9.1.1.1 9.9.5.2	14 6 11	31		
2		1.7.2	12	12		
3		1.6.3 9.11.1.5	10 4	14		
4		7.1.1 9.1.3.4 9.1.3.8	6 8 12	26		
5		1.1.2 9.1.3.2 9.1.3.2	3 4 4	11		
6		2.6.2	14	14		
7		1.1.4 9.2.3.6	2 12	14		
8		5.1.1 9.4.1.2 9.9.5.3	17 9 11	37		
9		8.1.1 9.1.1.3 9.4.5.2	13 10 5	28		
10		7.3.1 9.1.3.6 9.8.3.4	8 10 15	33		
11		1.13.3 9.2.4.4 9.8.1.1	12 9 7	28		
12		1.7.4 9.9.5.3	9 11	20		

Item	K	Score
Positioning	12	

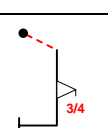
FIGURE TOTAL K = 268

INCLUDING POSITIONING = 280

Aircraft Type:

FREE PROGRAM CHECKED BY:

Signature:	Date:
IAC No.	

Judge
Name
Number

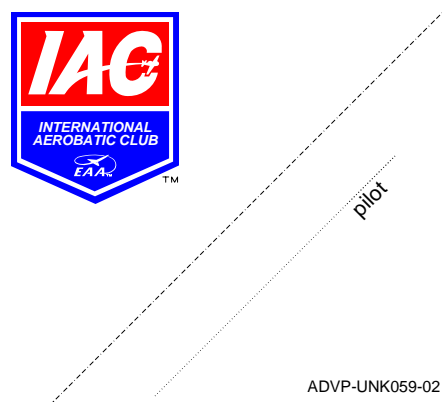



B	Contest:	Category: Advanced
Date:	Program: Unknown	Pilot's No. <input type="text"/>

wind direction

Pilot:

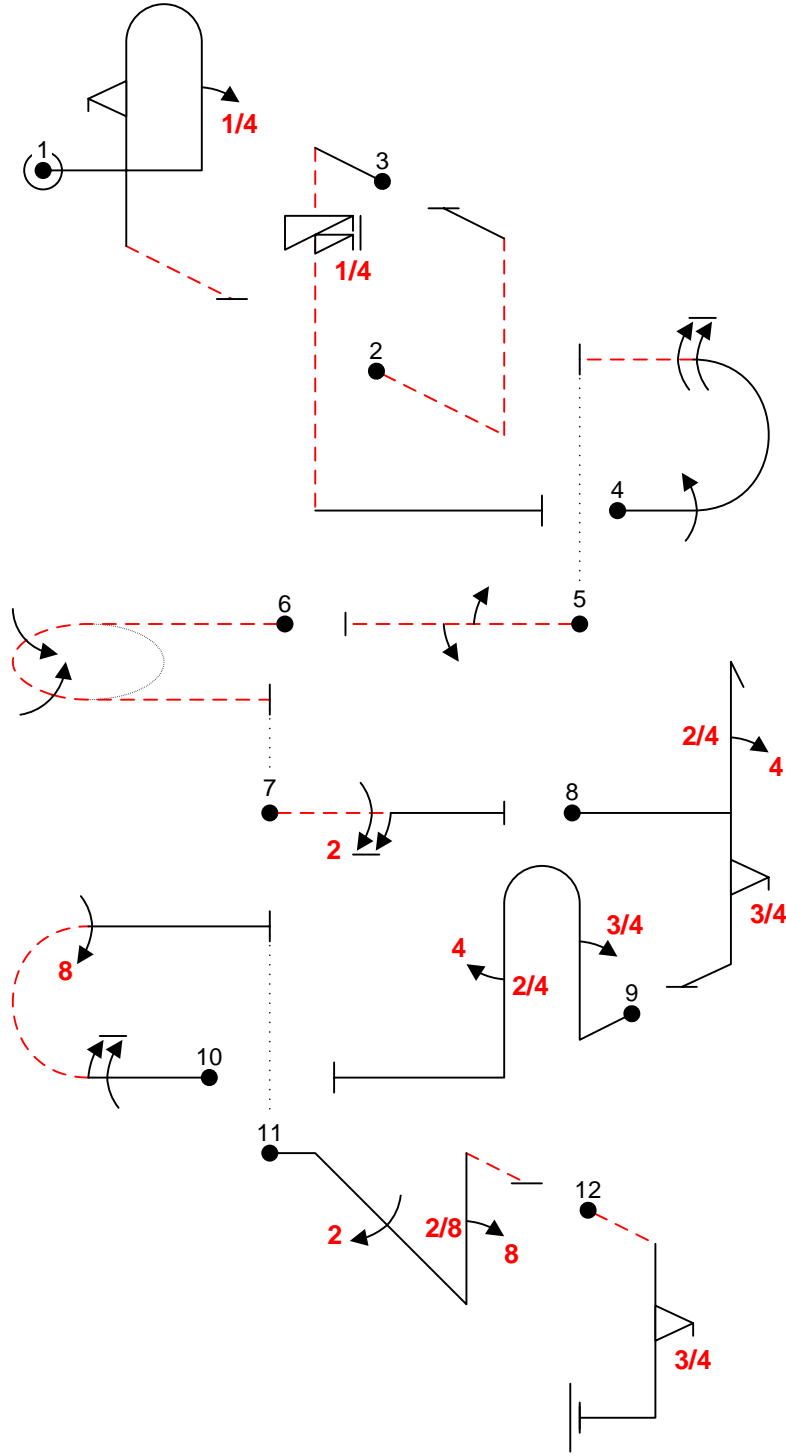

A/C:

(signature/date)

FREE PROGRAM CHECK BY:



C	Contest:	Category: Advanced
Date:	Program: Unknown	Pilot's No. <input type="text"/>

wind direction

Pilot:

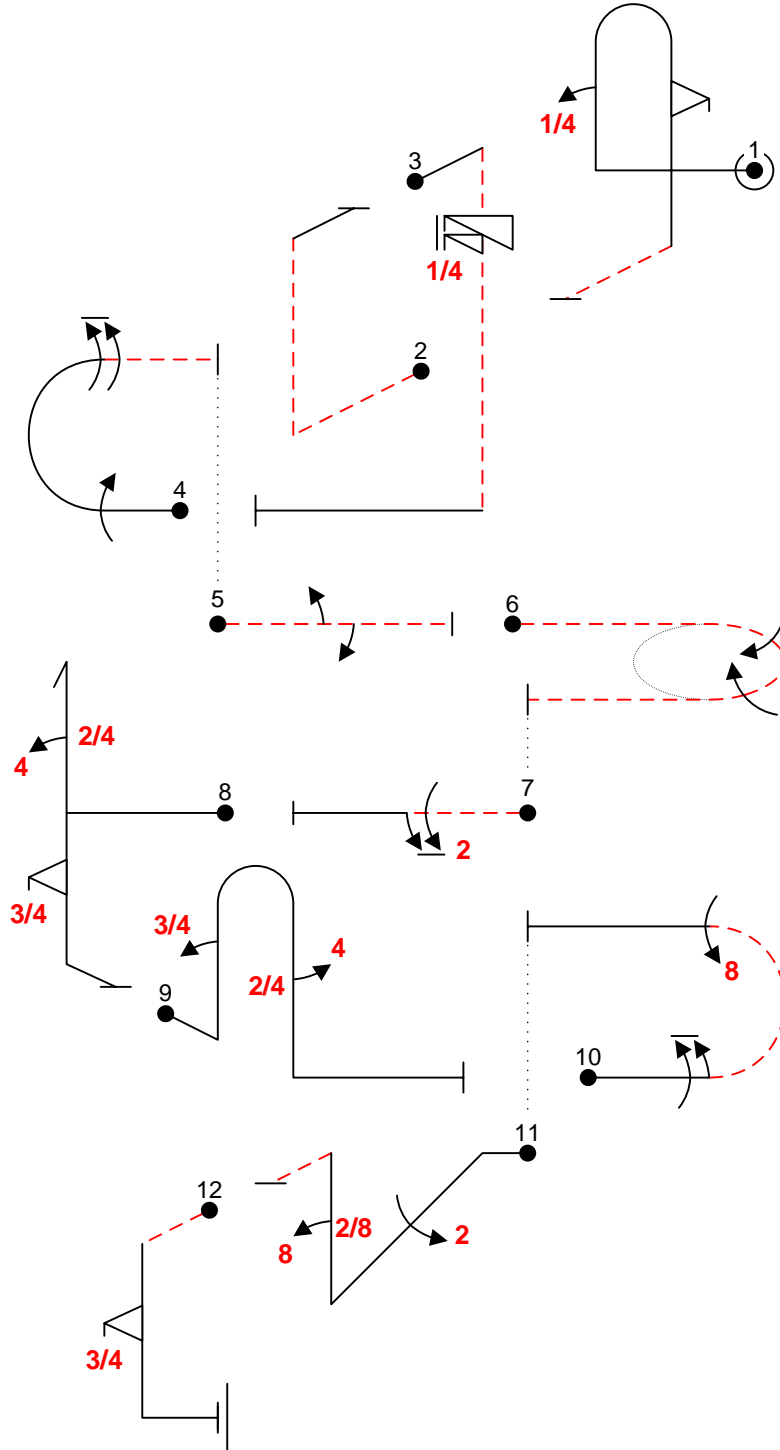

A/C:

(signature/date)

FREE PROGRAM CHECK BY: