















INTERNATIONAL AEROBATIC CLUB SCORESHEET										
A	Contest:			Date:	Category: Power Advanced	Programme: Free	pilot's number			
	No	Symbol	Cat. No.	K	Total K	Grade	Remarks	Item	K	Score
1		8.4.1.1 9.2.1.4 9.2.5.4 <b>F.P.</b>	13 13 9	<b>34</b> (35)				<b>Presentation</b>	30	
2		5.2.1.1 9.1.1.3 9.8.5.1	17 10 3	<b>30</b>				FIGURE TOTAL K =	300	
3		1.2.7.1 9.1.4.1 9.9.9.3	13 2 13	<b>28</b>				INC. PRESENTATION =	330	
4		1.1.6.1	10	<b>10</b>				Aircraft type: <b>SUKHOI 26</b>		
5		1.1.6.3 9.11.1.6	10 3	<b>13</b>				FREE PROGRAM CHECKED BY: Signature: _____ Printed Name: _____ IAC No: _____ Date: _____		
6		7.2.1.1 9.2.3.8	6 15	<b>21</b>						
7		1.1.1.4 9.2.3.6	2 12	<b>14</b>						
8		8.4.4.1 9.1.1.1	16 6	<b>22</b>						
9		5.2.1.4 9.1.5.3	22 6	<b>28</b>				Judge Name: _____ IAC # _____		
10		1.2.8.1 9.1.1.2 9.4.4.2	16 8 5	<b>29</b>				Assistant Name: _____ IAC # _____		
11		7.2.4.2 9.1.3.3 9.1.3.1 9.1.3.6	6 6 2 10	<b>24</b>						
12		1.1.1.1 9.9.3.4	2 11	<b>13</b>						
13		7.2.3.3 9.4.3.2 9.2.3.4	6 5 9	<b>20</b>				Cong Yan Pilot N2035U A/C		
14		2.1.2.1	14	<b>14</b>						

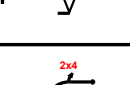

<b>B</b>	Contest:	Category: Power Advanced
	Date:	Program: Free
		Pilot's No. <input type="text"/>

Pilot: Cong Yan

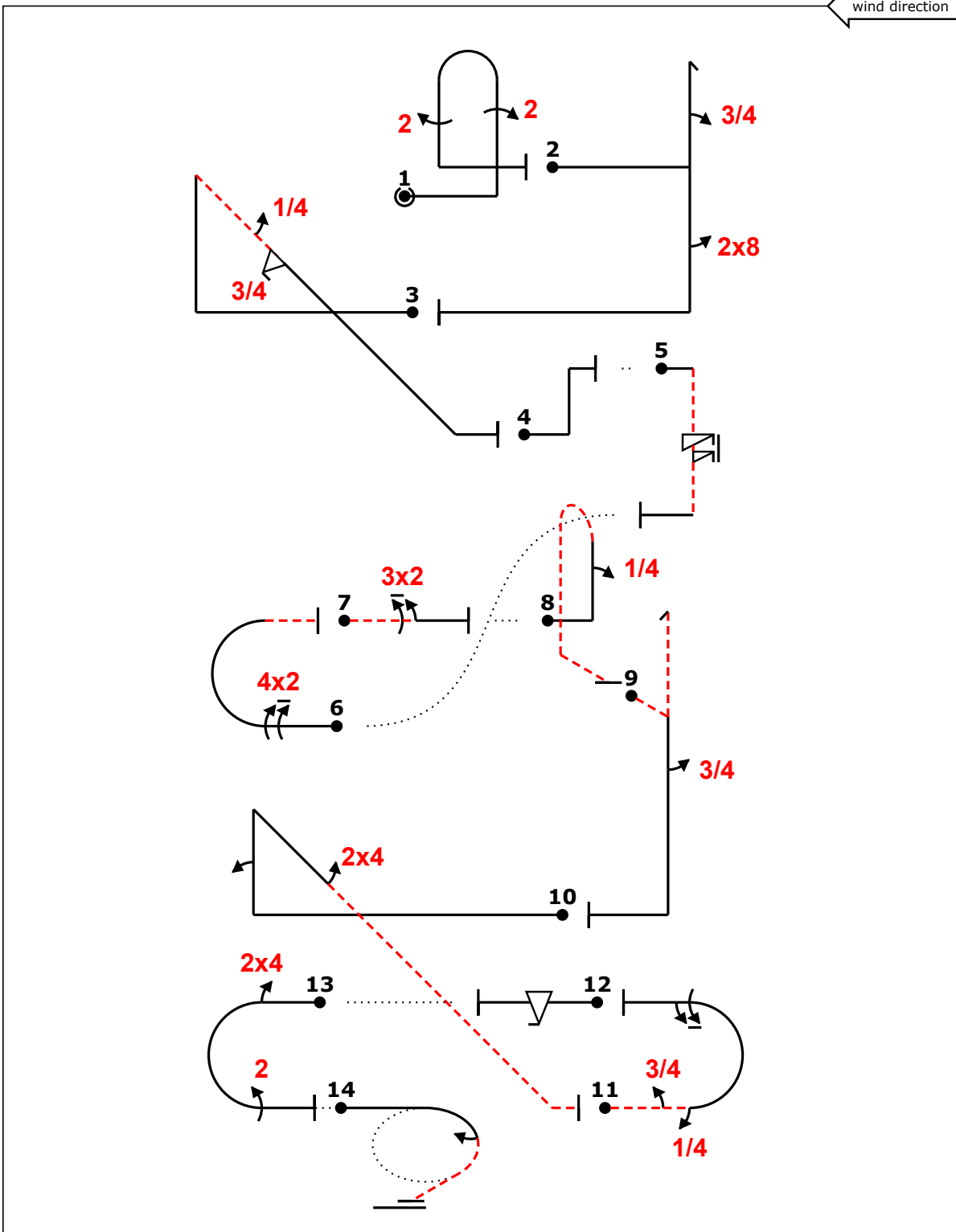

A/C: SUKHOI 26

(signature/date)

FREE PROGRAM CHECK BY:

1% ,22b^^,22^ ++,3h''8.++++ -2% -++++.k4',3f..... ^+v^^^++ (1,0) ^^^+iv'6s (-19,16) ,42m- -32 (2,0) /^^^++ ,4pb- -h3...--  
-+++++^^2k24.....'^-- -3,4m6 f (-8,0) ,24a22 (-2,0) /1j5-



<b>C</b>	Contest:	Category: Power Advanced
	Date:	Program: Free
		Pilot's No. <input type="text"/>

Pilot: Cong Yan

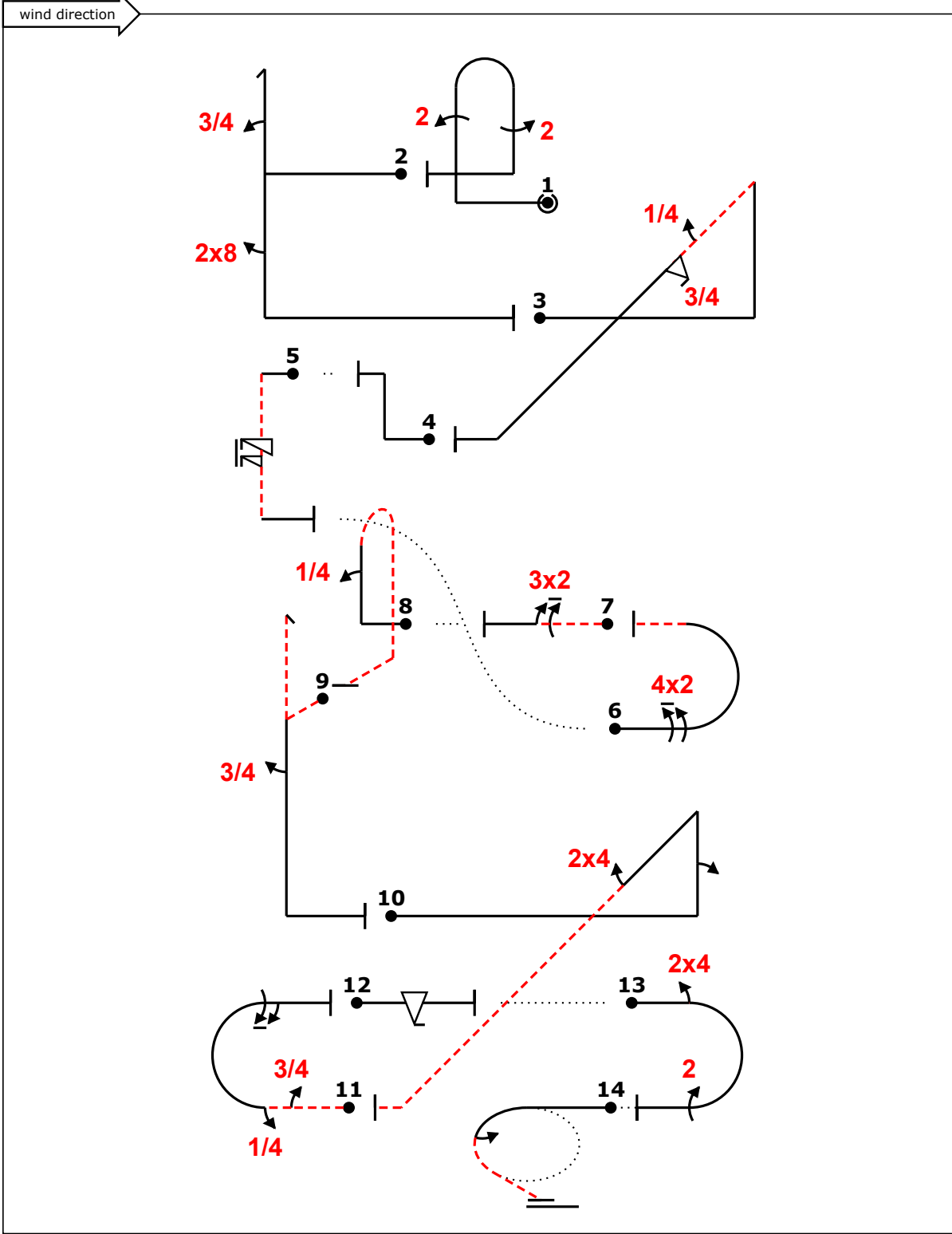

A/C: SUKHOI 26

(signature/date)

FREE PROGRAM CHECK BY:

1% ,22b^^,22` ++,3h''8.++++ -2% -++++.k4',3f..... `+v^^^` (1,0) ^^+iv'6s (-19,16) ,42m- -32 (2,0) /^^^`4pb- -h3...-  
-++++^2k24.....'=- -3,4m6 f (-8,0) ,24a22 (-2,0) /1j5-