















INTERNATIONAL AEROBATIC CLUB SCORESHEET															
A	Contest:			Date:	Category:	Programme:	pilot's number								
					Power Advanced	Free									
No	Symbol	Cat. No.	K	Total K	Grade	Remarks	Item	K	Score						
1		7.2.1.1 9.1.3.8 9.2.3.6 9.9.3.6	6 12 12 14	44			<b>Presentation</b>	30							
2		1.3.10.2 9.9.4.4	24 11	35					FIGURE TOTAL K =	300					
3		8.8.6.3 9.11.1.6 9.1.1.1 9.1.5.1	21 3 6 2	32			INC. PRESENTATION =	330							
4		7.2.2.1 9.1.3.3 9.1.3.1	6 6 2	14			Aircraft type: <b>MXS-RH</b>								
5		5.2.1.1 9.1.5.3	17 6	23			FREE PROGRAM CHECKED BY:  <table style="width:100%; border-collapse: collapse;"> <tr> <td style="border-right: 1px solid black; width: 33%; height: 100px; vertical-align: bottom;">Signature:</td> <td style="border-right: 1px solid black; width: 33%; height: 100px; vertical-align: bottom;">Printed Name:</td> <td style="width: 33%; height: 100px; vertical-align: bottom;">Date:</td> </tr> <tr> <td style="border-right: 1px solid black; height: 20px;">IAC No:</td> <td colspan="2"></td> </tr> </table>			Signature:	Printed Name:	Date:	IAC No:		
Signature:	Printed Name:	Date:													
IAC No:															
6		8.4.1.1 9.8.5.1	13 3	16											
7		8.8.1.1 9.1.5.2	18 4	22											
8		7.2.1.4 9.2.3.4 9.1.3.4	6 9 8	23											
9		1.1.7.1	9	9											
10		1.1.7.4	9	9											
11		8.4.3.1 9.4.5.2	15 5	20											
12		1.1.1.3 9.1.3.6	2 10	12											
13		7.2.3.2 9.1.3.2 9.2.3.8	7 4 15	26											
14		2.1.2.4	15	15											
										Judge Name:					
										IAC #					
							Assistant Name:								
							IAC #								



Adam Messenheimer  
N530RH  
Pilot  
A/C



<b>B</b>	Contest:	Category: Power Advanced
	Date:	Program: Free
		Pilot's No. <input type="text"/>

Pilot: Adam Messenheimer  
 wind direction

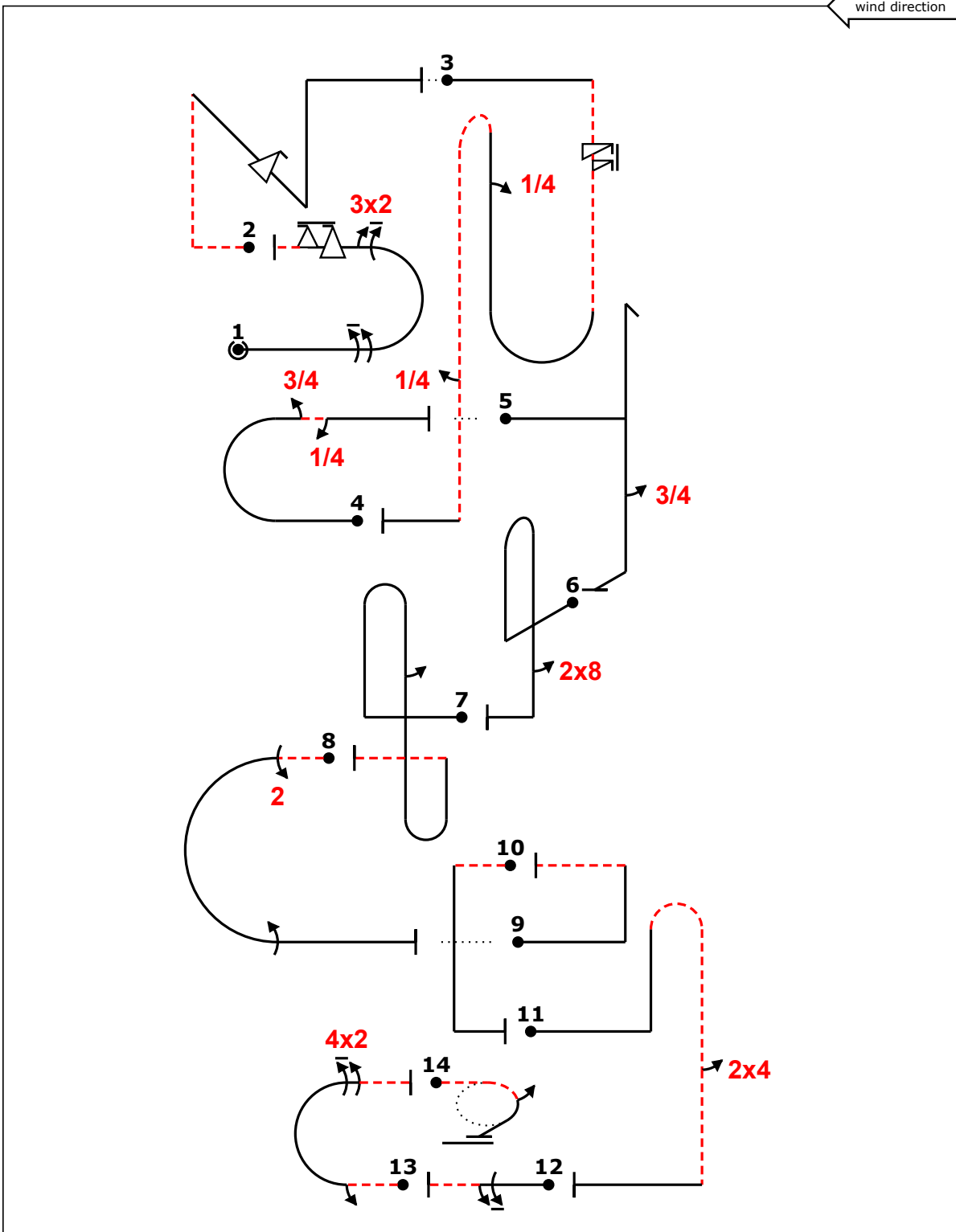

A/C: MXS-RH

(signature/date)

FREE PROGRAM CHECK BY:

```

.'9m,32;6f-''pn(f)+++ (-2,0) ---+6s...iBpb(,4).....',4..'> 'm'3,4++ (2,0) ---+h'3.' -1% +b..8+++ -2% +.'bb(~~2...')
)--- 8% -''22a1-- (4,0) -+v''--iv.''' +pb.'24.''+ 6- -2m42- -4% -1jo5
  
```



<b>C</b>	Contest:	Category: Power Advanced
	Date:	Program: Free
		Pilot's No. <input type="text"/>

Pilot: Adam Messenheimer

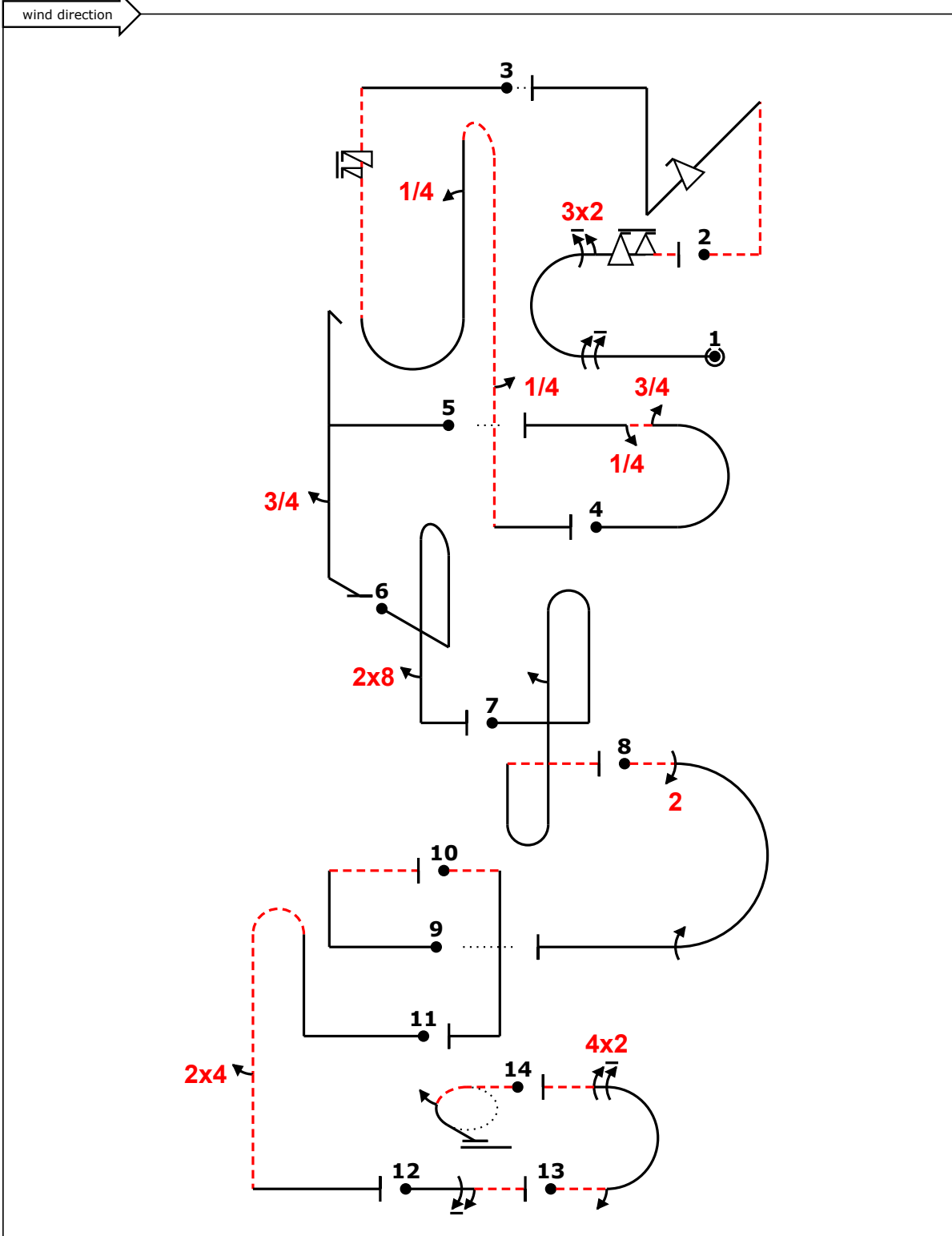

A/C: MXS-RH

(signature/date)

FREE PROGRAM CHECK BY:

..''9m,32;6f-'' -''pn(f)+-- (-2,0) ---+6s...iBpb(,4).....',4..> ''m''3,4+- (2,0) ---+''h''3.' -1% +b..8+'' -2% +.'''bb('''2...'  
)-- 8% -''22a1-- (4,0) -+v''-- -iv.''' +pb.'''24.'''+- 6- -2m42- -4% -1jo5