

INTERNATIONAL AEROBATIC CLUB SCORESHEET

A

Contest:

Date:













Category:

Programme:

 pilot's
number

 Power
Advanced

Free

No	Symbol	Cat. No.	K	Total K	Grade	Remarks	Item	K	Score
1		5.2.1.1 9.4.5.2	17 5	22			Presentation	30	
2		1.3.11.1 9.2.4.6	20 12	32			FIGURE TOTAL K =		300
3		8.6.1.4 9.12.1.4	12 7	19			INC. PRESENTATION =		330
4		5.2.1.4 9.1.5.5	22 9	31			Aircraft type: Extra 330SC		
5		8.4.1.1 9.1.1.2 9.1.5.3	13 8 6	27			FREE PROGRAM CHECKED BY: Signature: _____ Printed Name: _____ IAC No: _____ Date: _____		
6		8.5.6.1 9.1.3.8 9.1.4.6	10 12 10	32					
7		8.4.3.1 9.8.5.1	15 3	18					
8		1.2.6.1 9.1.1.1 9.9.4.4	14 6 11	31					
9		1.3.12.1 9.4.4.2	21 5	26				Judge Name:	
10		7.2.3.3 9.1.3.2 9.4.3.4	6 4 11	21				IAC #	
11		7.2.2.1 9.9.3.4 9.1.3.6	6 11 10	27				Assistant Name:	
12		2.1.3.1	14	14				IAC #	



.....
Christopher Magon Pilot

N330KM A/C



B	Contest:	Category:
	Date:	Program: Free

Pilot: Christopher Magon
 wind direction ←

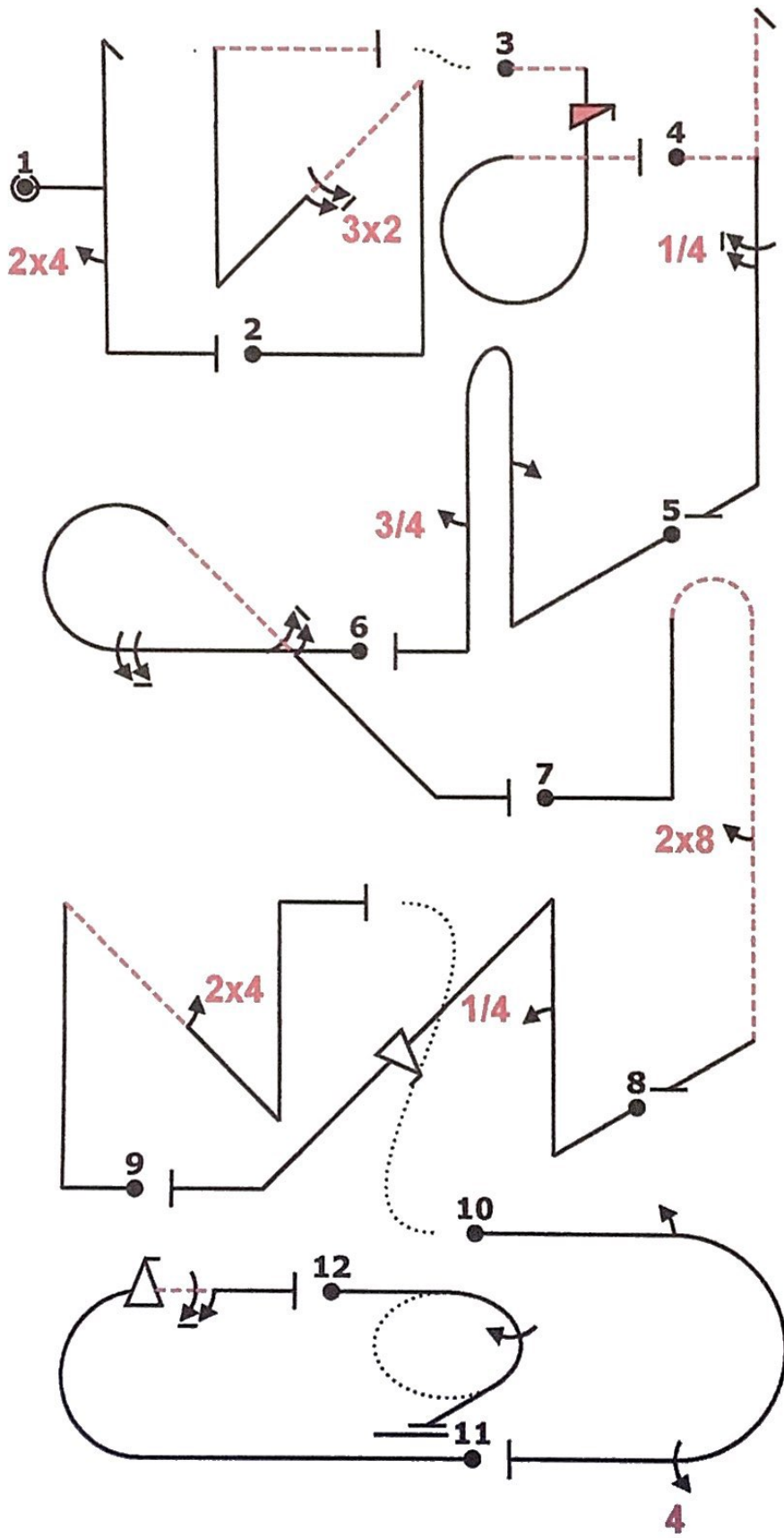

A/C: Extra 330SC

FREE PROGRAM CHECK BY: (signature/date)



C	Contest:	Category: Power Advanced
	Date:	Program: Free
		Pilot's No. <input type="text"/>

Pilot: Christopher Magon

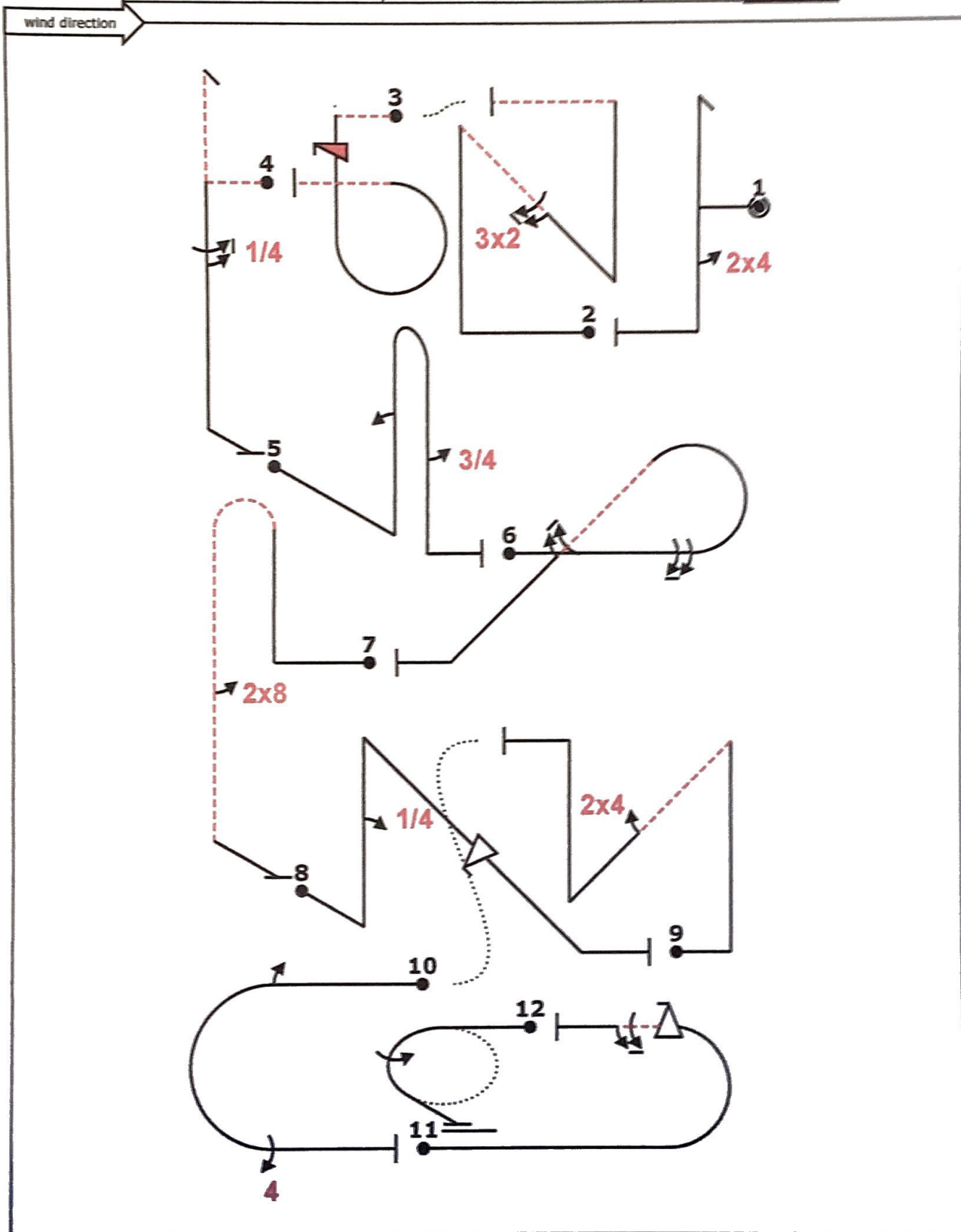

A/C: Extra 300C

(signature/date)

FREE PROGRAM CHECK BY: