

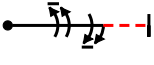









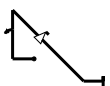

INTERNATIONAL AEROBATIC CLUB SCORESHEET

A

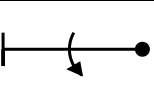
Contest:	Date:	Category: Power Advanced	Programme: Free	pilot's number	
----------	-------	--------------------------------	--------------------	-------------------	--

No	Symbol	Cat. No.	K	Total K	Grade	Remarks
1		1.1.1.3 9.1.3.8 9.1.3.6	2 12 10	24 SF 7		
2		5.2.1.4 9.4.5.2	22 5	27 SF 5		
3		5.3.1.1 9.1.5.4	18 8	26 SF 5		
4		1.3.11.1 9.4.4.2	20 5	25 SF 7		
5		1.1.7.4 9.12.1.4	9 7	16 SF 3		
6		8.4.3.1 9.1.1.1 9.1.5.1	15 6 2	23 SF 7		
7		8.4.1.1 9.1.1.3 9.8.5.1	13 10 3	26 SF 7		
8		1.2.6.1 9.1.1.2 9.9.4.4	14 8 11	33 SF 4		
9		5.2.1.1	17	17 SF 5		
10		1.1.1.1 9.1.3.4	2 8	10 SF 7		
11		7.2.2.1 9.2.3.6	6 12	18 SF 7		
12		7.2.3.3 9.9.3.6	6 14	20 SF 4		
13		7.2.1.1 9.2.3.8	6 15	21 SF 7		
14		2.1.2.2	14	14 SF 2		

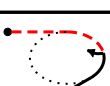
Presentation	30	
---------------------	-----------	--

FIGURE TOTAL K =	300
------------------	------------

INC. PRESENTATION =	330
---------------------	------------

Aircraft type: S300D	
--------------------------------	--

FREE PROGRAM CHECKED BY:	Signature:	
	Printed Name:	Date:
	IAC No:	

Judge Name:

IAC #

Assistant Name:

IAC #



Michael Lents Pilot
N540CG A/C



B	Contest:	Category:	
	Date:	Program:	Pilot's No. <input type="text"/>
		Power Advanced	
	Free		

Pilot: Michael Lents

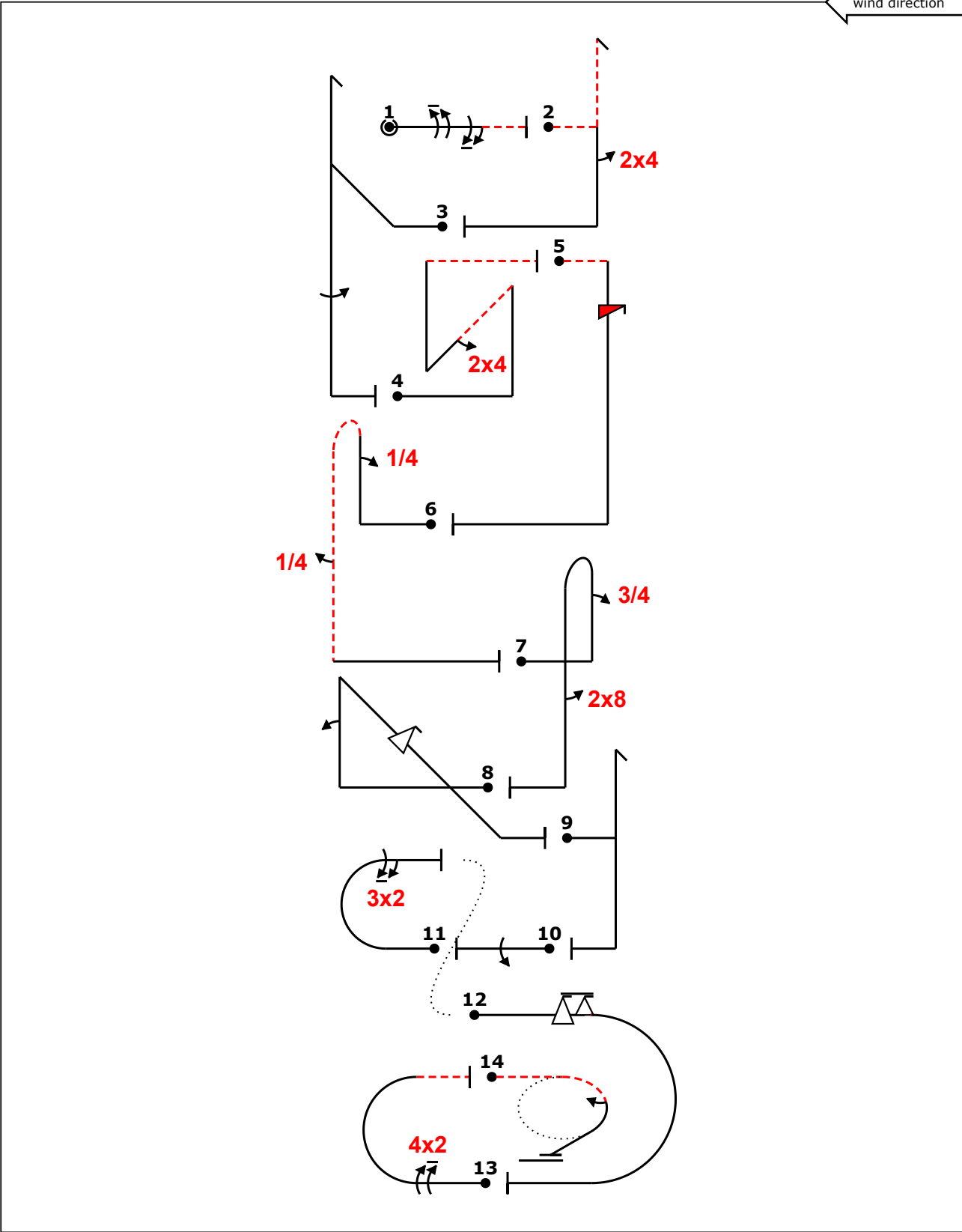

Check: 20-9-2023 23:07 OpenAero 2023.3.15 2023 iac advanced free Sequence is correct

A/C: S300D

(signature/date)

FREE PROGRAM CHECK BY:



C	Contest:	Category: Power Advanced
	Date:	Program: Free
		Pilot's No. <input type="text"/>

Pilot: Michael Lents

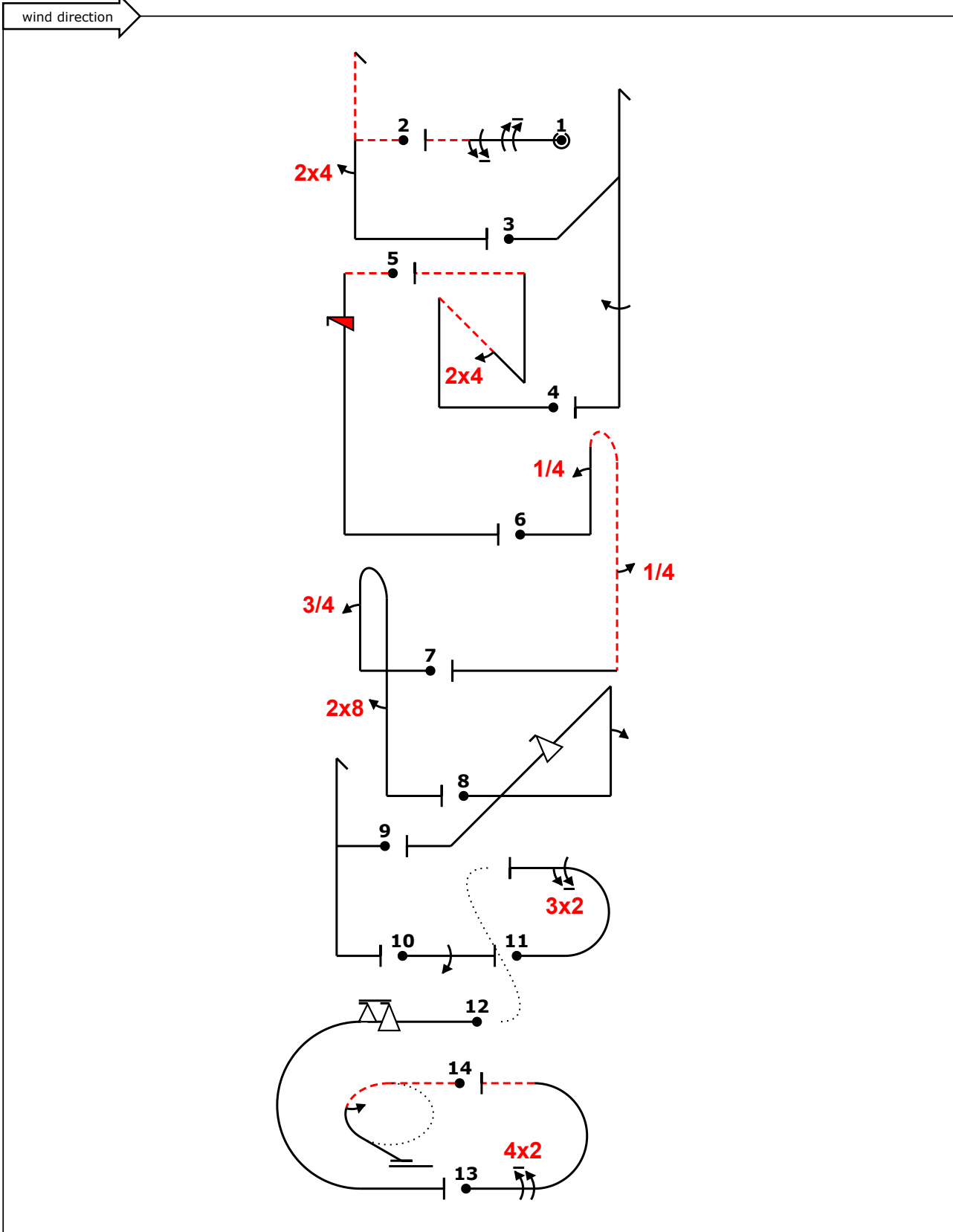

A/C: S300D

(signature/date)

FREE PROGRAM CHECK BY: