









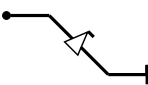

# INTERNATIONAL AEROBATIC CLUB SCORESHEET

# A

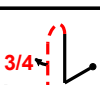
Contest:	Date:	Category: Power Advanced	Programme: Free	pilot's number	
----------	-------	--------------------------------	--------------------	-------------------	--

No	Symbol	Cat. No.	K	Total K	Grade	Remarks	Item	K	Score	
1		5.3.1.1 9.1.2.4	18 10	<b>28</b> SF 5			<b>Presentation</b>	30		
2		1.1.6.1 9.1.1.2	10 8	<b>18</b> SF 7			FIGURE TOTAL K =		300	
3		1.1.2.3 9.9.4.4	7 11	<b>18</b> SF 4			INC. PRESENTATION =		330	
4		8.5.6.1 9.8.4.2	10 7	<b>17</b> SF 7			Aircraft type: Extra 300			
5		1.3.12.1 9.4.4.2	21 5	<b>26</b> SF 7			FREE PROGRAM CHECKED BY: Signature: _____ Printed Name: _____ IAC No: _____ Date: _____			
6		1.3.16.3 9.11.1.6 9.4.2.2	21 3 7	<b>31</b> SF 3						
7		8.4.1.1 9.9.5.3	13 11	<b>24</b> SF 4						
8		8.4.3.1 9.1.5.3	15 6	<b>21</b> SF 7						
9		1.2.7.1 9.1.4.1 9.1.4.3	13 2 6	<b>21</b> SF 7						
10		7.2.1.1 9.1.3.4	6 8	<b>14</b> SF 7				Judge Name:		
11		8.8.1.4 9.4.5.2	18 5	<b>23</b> SF 7				IAC #		
12		5.2.1.1 9.1.5.4	17 8	<b>25</b> SF 5				Assistant Name:		
13		7.2.2.1 9.2.3.4 9.4.3.2	6 9 5	<b>20</b> SF 7				IAC #		
14		2.1.3.1	14	<b>14</b> SF 2						

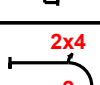
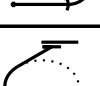

Barrett Hines Pilot  
 N410WB A/C



<b>B</b>	Contest:	Category: Power Advanced
	Date:	Program: Free
		Pilot's No. <span style="border: 1px solid black; display: inline-block; width: 40px; height: 20px; vertical-align: middle;"></span>

Pilot: Barrett Hines  
wind direction

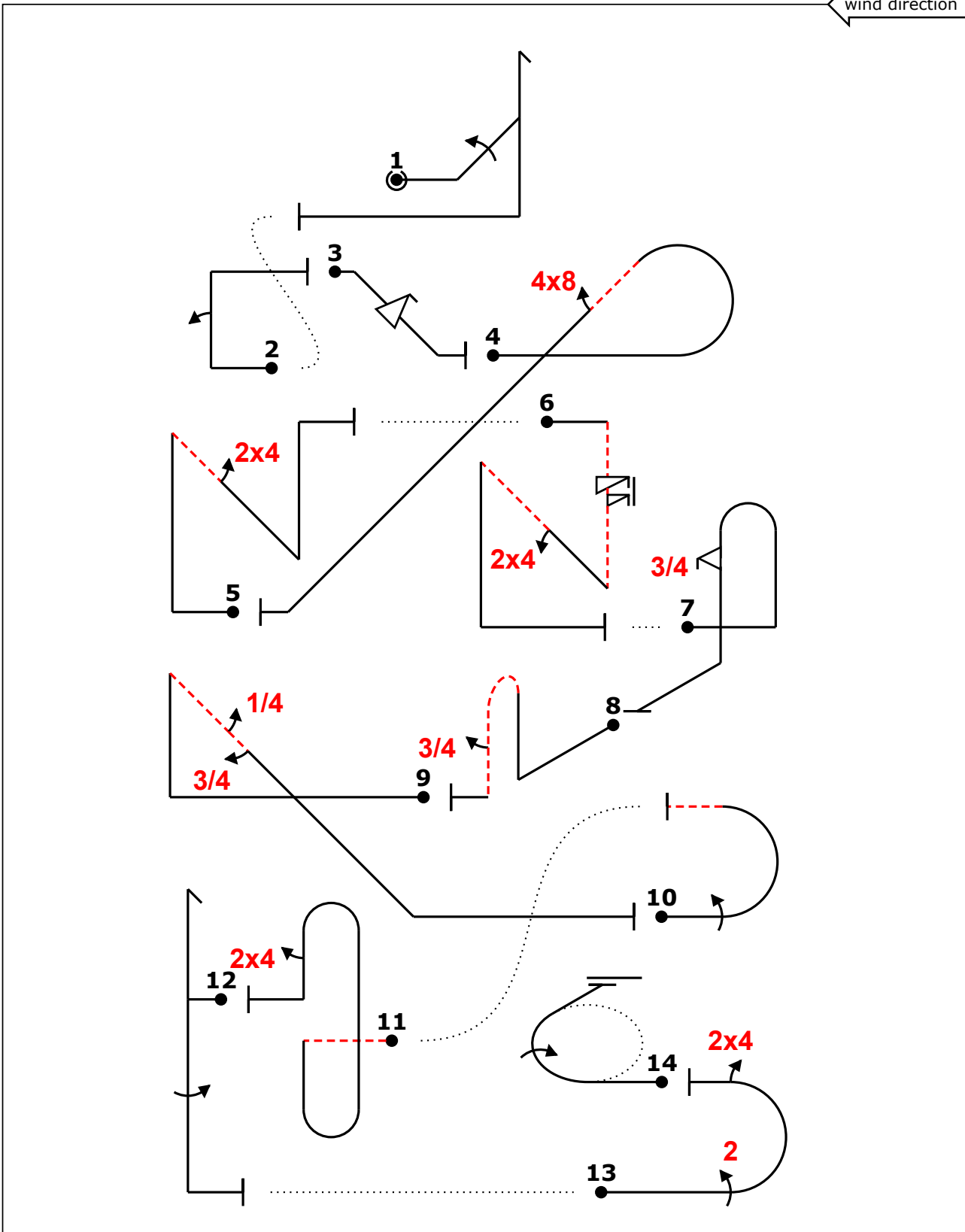

A/C: Extra 300

(signature/date)

FREE PROGRAM CHECK BY:

```
-2% ~1dh(~~).+++++ (2,11) v2`+ ~~~+idf+~~ `c',48.....'+` .n(~~24.) (10,0) 6sin(~~24.)'+~~ [
2,0] `b`~~~3f.+~ -1% ++`pb`~~3+~~~> ~~~~~k`4',3...++++ 1m- (-16,17) -`ibb(~~,24+~~~`+h.1.'
(22,0) .''22m,24..+~~~~~`+1j1>
```



<b>C</b>	Contest:	Category: Power Advanced
	Date:	Program: Free
		Pilot's No. <input type="text"/>

Pilot: Barrett Hines

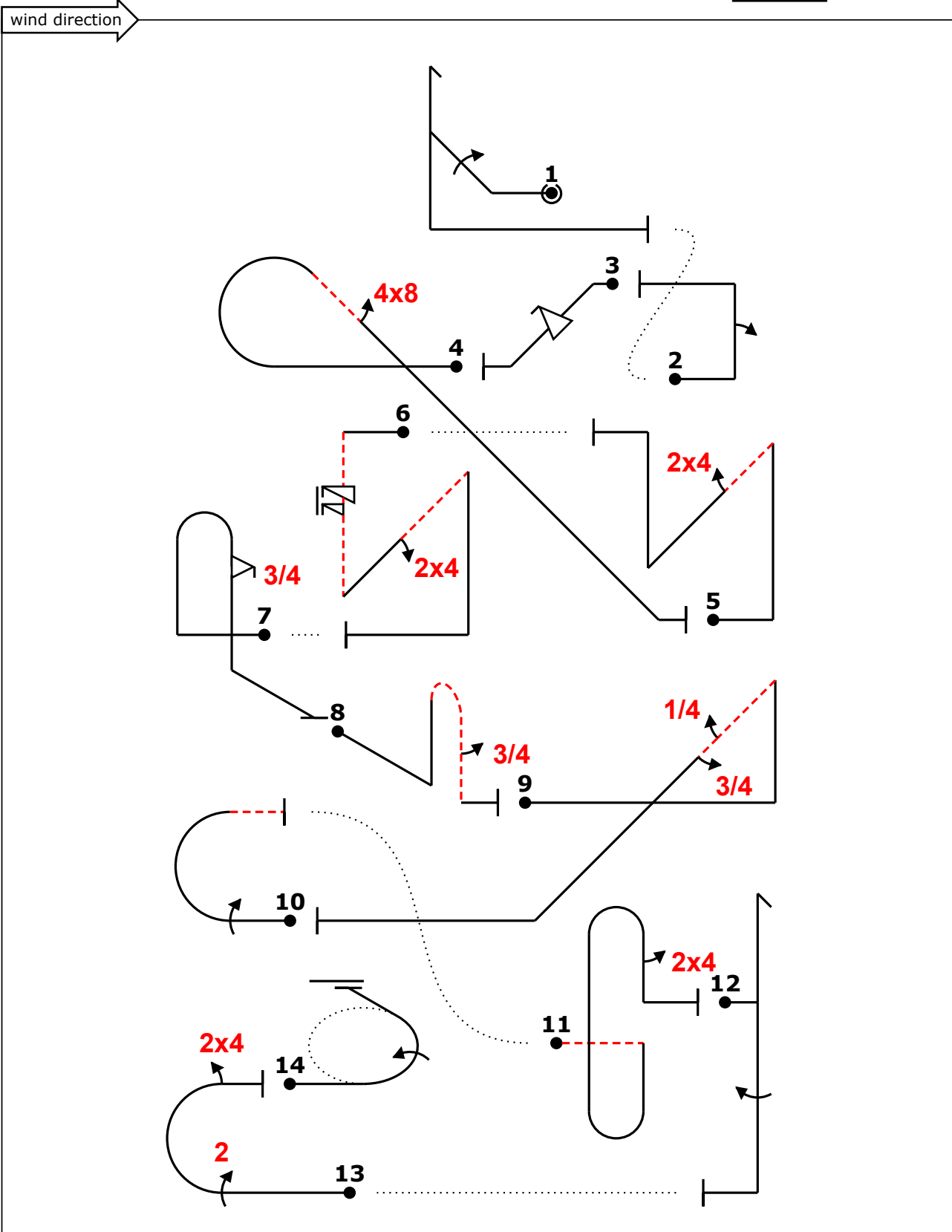

A/C: Extra 300

(signature/date)

FREE PROGRAM CHECK BY:

```
-2% ~1dh(~~).+++++ (2,11) v2`+ ~~~+idf+~~ `c',48.....'+` .n(~~24.) (10,0) 6sin(~~24.)'+~~ [
2,0] `b`~~~3f.+~ -1% ++'pb`~~3+~~> ~~~~~k`4',3...++++ 1m- (-16,17) -`ibb(~~,24+~~`~+h.1.'
(22,0) .''22m,24..+~~~~~+1j1>
```