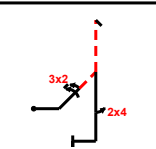
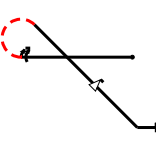
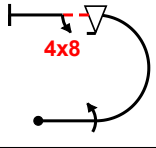
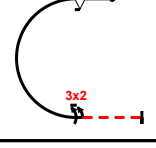
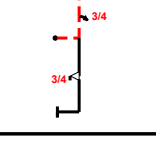
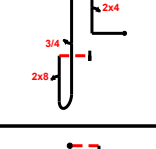
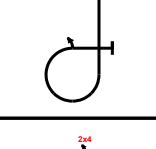
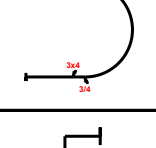
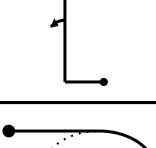
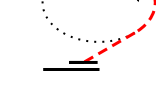

# INTERNATIONAL AEROBATIC CLUB SCORESHEET

# A

Contest: <b>Nationals/KSLN</b>	Date: <b>9/24-29/23</b>	Category: <b>Power Advanced</b>	Programme: <b>Free</b>	pilot's number <div style="border: 2px solid black; width: 40px; height: 40px; margin: 0 auto;"></div>
-----------------------------------	----------------------------	--	---------------------------	--

No	Symbol	Cat. No.	K	Total K	Grade	Remarks	Item	K	Score	
<b>1</b>		5.3.2.1 9.2.2.6 9.4.5.2	24 14 5	<b>43</b>			<b>Presentation</b>	<b>30</b>		
<b>2</b>		8.5.7.1 9.1.3.6 9.9.4.4	12 10 11	<b>33</b>			FIGURE TOTAL K =		<b>300</b>	
<b>3</b>		7.2.2.1 9.1.3.4 9.9.3.4 9.8.3.2	6 8 11 7	<b>32</b>			INC. PRESENTATION =		<b>330</b>	
<b>4</b>		7.2.4.3 9.9.3.2 9.2.3.6	6 11 12	<b>29</b>			Aircraft type:		<b>MX2</b>	
<b>5</b>		5.2.1.4 9.1.1.3 9.9.5.3	22 10 11	<b>43</b>			FREE PROGRAM CHECKED BY:  Signature: _____ Printed Name: _____ IAC No: _____ Date: _____			
<b>6</b>		8.8.1.1 9.4.1.2 9.1.5.3 9.8.1.1	18 9 6 7	<b>40</b>				Judge Name:		
<b>7</b>		8.6.2.4 9.12.1.4 9.1.3.2	12 7 4	<b>23</b>				IAC #		
<b>8</b>		7.2.3.3 9.4.3.2 9.1.3.3 9.4.3.3	6 5 6 8	<b>25</b>				Assistant Name:		
<b>9</b>		1.1.6.1 9.1.1.2	10 8	<b>18</b>				IAC #		
<b>10</b>		2.1.2.1	14	<b>14</b>						

**Marty Flournoy** Pilot  
**N540RH** A/C

<b>B</b>	Contest:	Nationals/KSLN	Category:	Power Advanced
	Date:	9/24-29/23	Program:	Free
			Pilot's No.	<input style="border: 2px solid black;" type="text"/>

Pilot: Marty Flournoy

wind direction

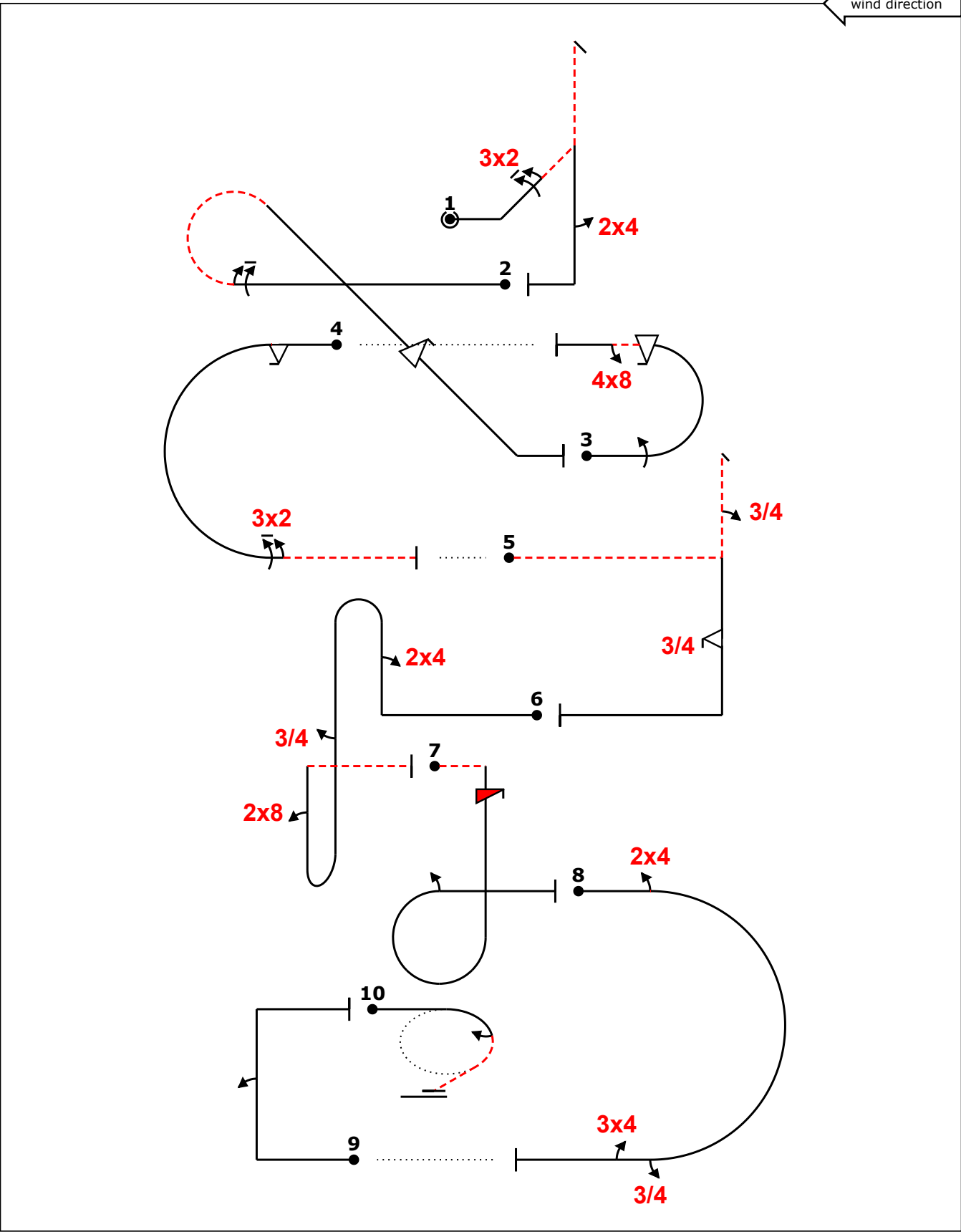

A/C: MX2

(signature/date)

FREE PROGRAM CHECK BY:

<b>C</b>	Contest:	Nationals/KSLN	Category:	Power Advanced
	Date:	9/24-29/23	Program:	Free
			Pilot's No.	<input style="border: 2px solid black; width: 50px; height: 20px;" type="text"/>

Pilot: Marty Flournoy

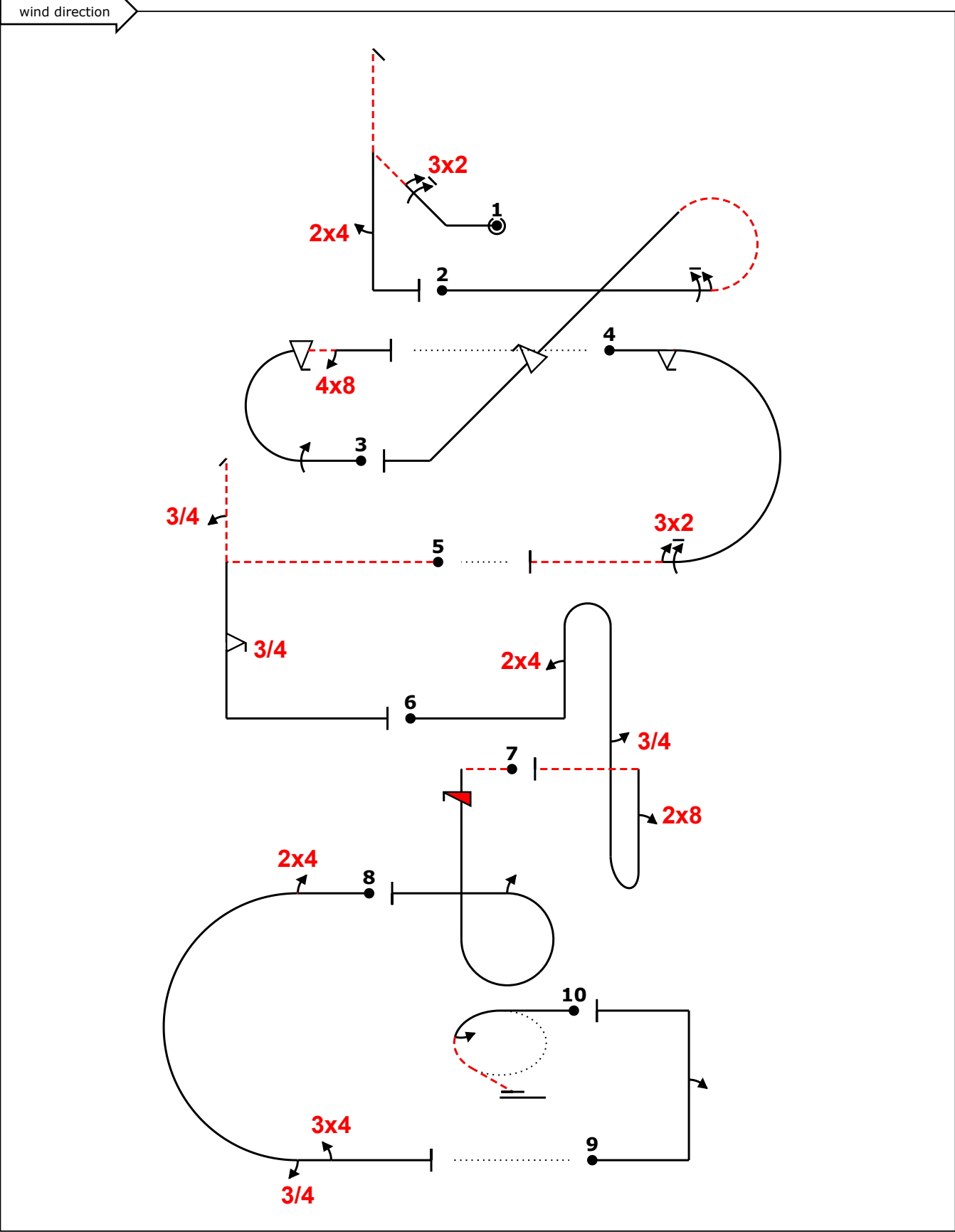

A/C: MX2

(signature/date)

FREE PROGRAM CHECK BY: